

Maintenance Manual

Monogram Series

UHF MOBILE RADIO
MODEL MGM 450



NOTICE!

This manual covers Ericsson and General Electric products manufactured and sold by Ericsson Inc.

NOTE

Repairs to this equipment should be made only by an authorized service technician or facility designated by the supplier. Any repairs, alterations or substitution of recommended parts made by the user to this equipment not approved by the manufacturer could void the user's authority to operate the equipment in addition to the manufacturer's warranty.

NOTICE!

The software contained in this device is copyrighted by Ericsson Inc. Unpublished rights are reserved under the copyright laws of the United States.

This manual is published by **Ericsson Inc.**, without any warranty. Improvements and changes to this manual necessitated by typographical errors, inaccuracies of current information, or improvements to programs and/or equipment, may be made by **Ericsson Inc.**, at any time and without notice. Such changes will be incorporated into new editions of this manual. No part of this manual may be reproduced or transmitted in any form or by any means, electronic or mechanical, including photocopying and recording, for any purpose, without the express written permission of **Ericsson Inc.**

MONOGRAM SERIES LBI-38865

TABLE OF CONTENTS

TABLE OF CONTENTS	
SPECIFICATIONS	1-3
GENERAL	1
RECEIVER (PER EIA RS-204-C)	2
TRANSMITTER (PER EIA RS-152-C)	3
OPTIONS AND ACCESSORIES	4
UNPACKING	5
GENERAL DESCRIPTION	6
DESCRIPTION OF CONTROLS	7-8
OPERATION	9-10
CIRCUIT ANALYSIS	11-13
RECEIVER	11
TRANSMITTER	12
PREVENTIVE MAINTENANCE	14
DISASSEMBLY	15-16
TOP AND BOTTOM COVERS	15
FRONT PANEL	15
RF BOARD	15
DIGITAL BOARD	16
PROGRAMMING INSTRUCTION	17
TEST EQUIPMENT SETUP	18
ALIGNMENT PROCEDURE	19-22
SUGGESTED TEST EQUIPMENT	19
PROGRAMMING FOR ALIGNMENT	19
PLL ALIGNMENT	20
TRANSMITTER ALIGNMENT	20
RECEIVER ALIGNMENT	22
RF BOARD ALIGNMENT AND TEST POINTS	24
DIGITAL BOARD ALIGNMENT AND TEST POINTS	25
PERFORMANCE TEST	26-27
TRANSMITTER PERFORMANCE TEST	26
RECEIVER PERFORMANCE TESTS	27
COMPONENT REPLACEMENT	29-30

MONOGRAM SERIES LBI-38865

TABLE OF CONTENTS

<i>ELECTRICAL PARTS LIST</i>	31
<i>PRINTED CIRCUIT BOARDS</i>	32
<i>TOP VIEW 406136-F ISSUE: H / RF BOARD</i>	32.1
<i>BOTTOM VIEW 406136-F ISSUE: H / RF BOARD</i>	32.2
<i>TOP VIEW 406137-E ISSUE: H / DIGITAL BOARD</i>	32.3
<i>BOTTOM VIEW 406137-E ISSUE: H / DIGITAL BOARD</i>	32.4
<i>MISC. PRINTED CIRCUIT BOARDS</i>	32.5
<i>MISC. PRINTED CIRCUIT BOARDS</i>	32.6
<i>EXPLODED VIEW AND PARTS LIST</i>	33
<i>SCHEMATICS</i>	34

MONOGRAM SERIES LBI-38865

SPECIFICATIONS

SPECIFICATIONS

GENERAL

Frequency Range

A Band	400-440 MHz
C Band	450-470 MHz
E Band	470-512 MHz

Channels

16 maximum

Channel Spacing

25 kHz Programmable
(In 6.25 kHz Steps)

Input Voltage

13.8 VDC Negative Ground

Current Drain

Standby	0.15 Amp
Receive	0.5 Amp
Transmit	8 Amp

Temperature Range

-30° to + 60° C

Dimensions

2 x 6 x 8.25 inches
(51 x 152 x 210 mm)

Weight

4 lbs., 3 oz. (1.9kg)
With Mic.

FCC Compliance

Parts 15, 22, 74, 90, 95

FCC ID Designation

400-440 MHz	F3JSM445A
450-470 MHz	F3JSM445C
470-512 MHz	F3JSM445E

DOC (Canada) Type Approval

400-440 MHz	N / A
450-470 MHz	287194100I
470-512 MHz	N / A

MONOGRAM SERIES LBI-38865

SPECIFICATIONS

RECEIVER (PER EIA RS-204-C)

RF Input Impedance	50 Ohms Nominal
Sensitivity:	
(EIA 12 dB SINAD)	0.35 uV
20 dB Quieting	0.50 uV
Squelch Sensitivity	0.20 uV Threshold
Selectivity	-80 dB
Intermodulation	-70 dB
Modulation Acceptance Bandwidth	±7.5 kHz
Spurious and Image	-70 dB
Audio Power Output	5 W (@10% Dist. into 40 W Load)
Frequency Stability	± 0.0005%
Operational Bandwidth	10 mHz (3dB degradation at band limits)

UHF PROGRAMMING CHART RECEIVE

Frequency Spread	Band Width	Factory Programmed Freq. Spreads
400-440 MHz	10 MHz	405-415 MHz (3 dB Degradation at limits)
450-470 MHz	10 MHz	460-470 MHz (3 dB Degradation at limits)
470-512 MHz	10 Mhz	500-510 MHz (3 dB Degradation at limits)

MONOGRAM SERIES LBI-38865

SPECIFICATIONS

TRANSMITTER (PER EIA RS-152-C)

RF Power Output	40 Watts (adjustable)
RF Output Impedance	50 Ohms
Spurious and Harmonics	-70 dBc
Modulation	16KOF3E
FM Hum and Noise	-45 dB Nominal
Audio Distortion	< 3 % @ 1000Hz
Frequency Stability	0.0005%
Operational Bandwidth	20 mHz (3dB degradation at band limits)

UHF PROGRAMMING CHART TRANSMIT

Frequency Spread	Band Width	Factory Programmed Freq. Spreads
400-440 MHz	20 MHz	405-420 MHz (3 dB Degradation at limits)
450-470 MHz	20 MHz	450-470 MHz (3 dB Degradation at limits)
470-512 MHz	20 Mhz	490-510 MHz (3 dB Degradation at limits)

MONOGRAM SERIES LBI-38865 SPECIFICATIONS

OPTIONS AND ACCESSORIES

CONTROL STATION OPTIONS:



Desk Microphone MGMC5H



External Speaker MGZM7C



Power Supply MGPS5V

NOT SHOWN:

Antenna - MGAN1A

Relay Kit - MGSU1C

Noise Suppression Kit - MGPD1A

MONOGRAM SERIES LBI-38865

UNPACKING

UNPACKING

Check the carton and packing material carefully for the following items:

1. Transceiver Unit
2. Microphone
3. DC power cord
4. Mobile Mounting Bracket
5. Assembly Hardware
6. Operating Guide

Styrofoam not used

Inner Packing is now cardboard tray box.

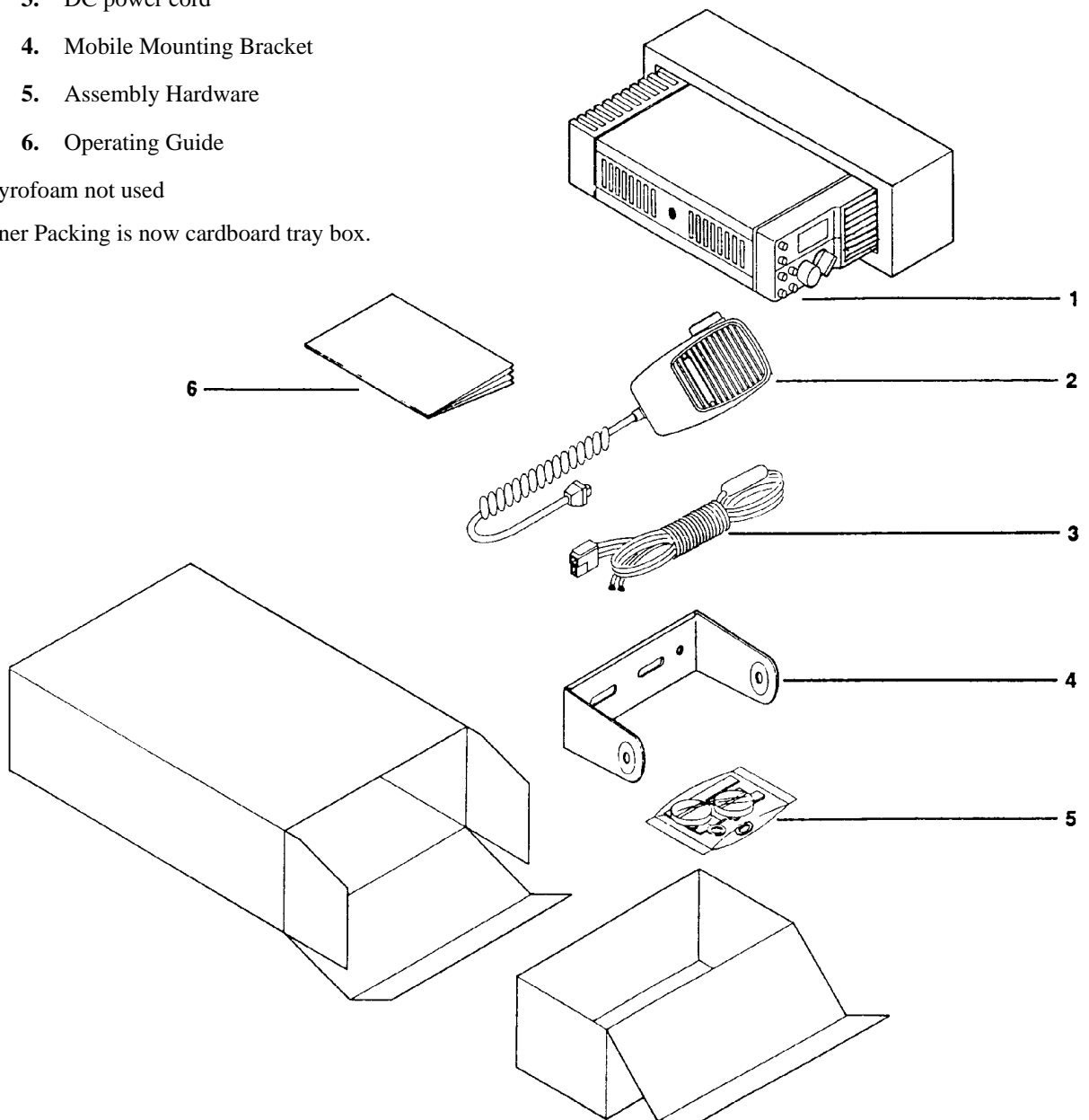

Figure 1 - Unpacking Diagram

MONOGRAM SERIES LBI-38865

INTRODUCTION

INTRODUCTION

The Conventional Monogram Series Radio is a rugged two-way FM mobile radio which operated in the 400-440 MHz, 450-470 MHz or the 470-512 MHz band split. The Monogram is a synthesized radio utilizing microcomputer technology to provide reliable high quality simplex two-way mobile communications. Its transmitter output power level is 40 watts over the wide bandwidth, with an allowable 10 MHz maximum receive channel separation. The basic radio package includes the following features:

- * **Microprocessor Control**
- * **Synthesized RF Channel selection (frequency control)**
- * **Vacuum Fluorescent Channel Selection Display**
- * **Channel Guard (CTCSS) Encode/Decode**
- * **Digital channel Guard (DCG) Encode/Decode**
- * **Priority Scan**
- * **± 5 PPM frequency stability**
- * **Field Programmable with PC**
- * **Variable Squelch**
- * **Internal 5-watt Speaker, with volume control**
- * **Side Mounted Microphone Connector**
- * **Rear Mounted Antenna Connector (SO-239)**
- * **Rear power connections**

The small size of the Monogram radio makes it ideal for front mounting in conventional vehicles. The radio is operated with a simple hand held microphone in combination with the operating controls described in the following section.

MONOGRAM SERIES LBI-38865

DESCRIPTION OF CONTROLS

DESCRIPTION OF CONTROLS

FRONT PANEL CONTROLS

1. Squelch Control: The squelch control will silence the receiver when no signal is being received.
2. ON/OFF/VOLUME Control: This is the main power switch and volume control.
3. Monitor Button (2): This button performs three functions:
 - a. Disables tone or digital squelch options when in receive mode.
 - b. Returns to normal radio operation from the programming mode.
 - c. Controls display intensity.
4. Auxiliary Speaker Button (1): This button silences the internal speaker and connects the auxiliary speaker (requires the auxiliary option printed circuit board to be installed). It also deletes channels from the scan list while in the programming mode.
5. SCAN Push Button (S): This button turns the scan function "ON" (indicated by a red backlight) and "OFF". It also serves as the ENTER function during SCAN programming.
6. PRIORITY SCAN Push Button (P): This button turns the PRIORITY SCAN function "ON" (indicated by a red backlight) and "OFF". It also provides access to the programming mode when the radio is turned on.
7. Channel Change buttons (CH): The channel change buttons allow the operator to scroll either up or down through the programmed channels.
8. Call Light Indicator (CALL): This green Light Emitting Diode (LED) indicator illuminates to indicate activity on the channel during receive when coded squelch or digital signaling options are used.
9. Busy Channel Indicator (BUSY): This yellow Light Emitting Diode (LED) indicator illuminates to indicate activity on the channel during receive.
10. Transmit LED Indicator (TX): This red Light Emitting Diode (LED) indicator illuminates during transmit mode. It also will flash to indicate that the synthesizer is out of lock.
11. Channel Display: The front panel display indicated channel number, priority scan numbers, programming mode and error messages.

FIGURE 2 - Front Panel Controls

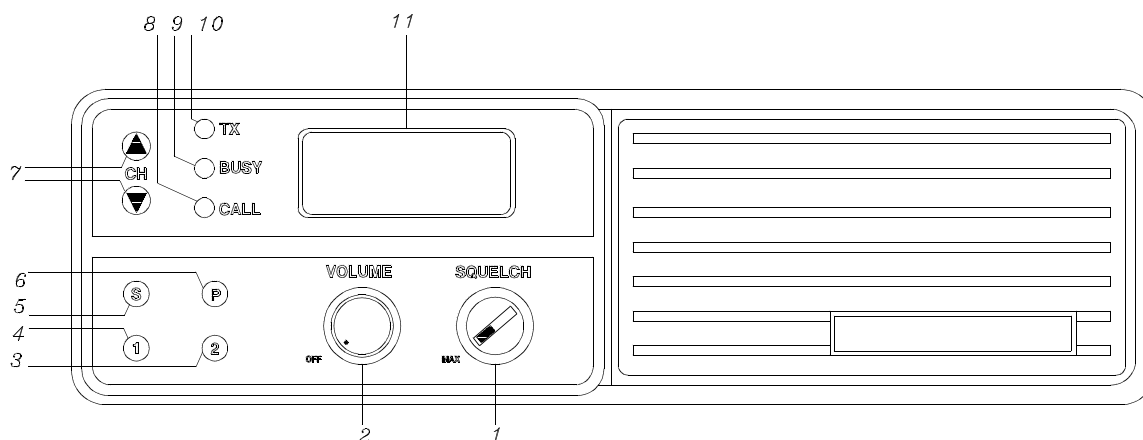

MONOGRAM SERIES LBI-38865

DESCRIPTION OF CONTROLS

BACK PANEL CONNECTORS

1. External Speaker Connector: This 3.5mm diameter jack is provided for a 4 ohm external speaker. The internal speaker is silenced when the external speaker is connected.
2. Auxiliary Speaker Connector: This 3.5mm diameter jack is provided for an auxiliary speaker (Option MGSU1C Relay Kit is required).
3. Antenna Connector: An SO-239 type connector. The output load must be 50 ohms.
4. DC 13.8V Connector: Polarized plug for 13.8 VDC power input - FOR NEGATIVE GROUND SYSTEMS ONLY.

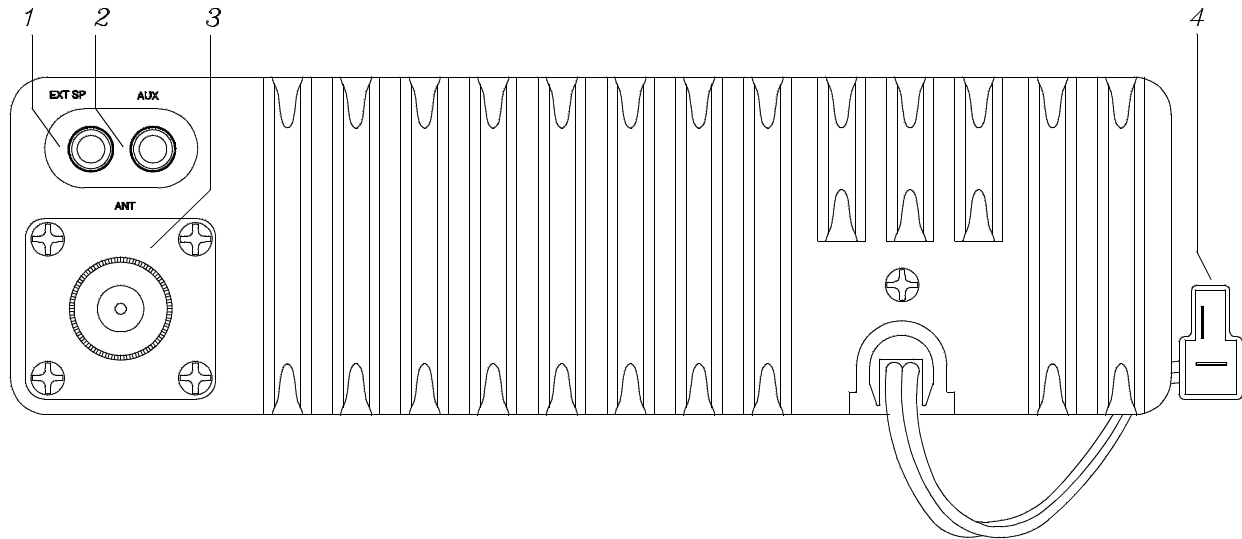

FIGURE 3 - Back Panel Controls

MONOGRAM SERIES LBI-38865

OPERATION

OPERATION

- **NOTE:** *The following description briefly outlines the operation of your UHF synthesized mobile radio. Consult the operators manual for a complete description of all the modes of operation for which the radio is capable.*

RADIO ON/OFF, POWER UP

1. Turn the radio on by turning the VOLUME control one-half turn clockwise. After 4000 appears in the display and the power up alert tone is generated, the display will change to the #1 priority channel. If no priority channel has been programmed, the display will change to channel 1.
2. Turn the radio off by rotating the VOLUME control fully counter-clockwise.

RECEIVING A CALL

1. Turn the radio on and select the desired channel.
 2. Depress the monitor button (2) if necessary to illuminate its backlight. Adjust the volume control to a comfortable listening level.
 3. Rotate the SQUELCH control clockwise until the squelch noise (rushing sound) is no longer present.
 4. Depress the MONITOR button (2) to extinguish the backlight.
- **NOTE:** *If the radio is equipped with coded squelch options, depress the MONITOR button (2) to enable the option; the CALL indicator will no longer be illuminated.*

TRANSMITTING

1. Turn the radio on and select the desired channel.
2. Pick up the microphone and listen briefly to insure the channel is clear. Alternatively, leave the microphone on-hook and depress the MONITOR button (2).
3. Depress the PTT switch on the side of the microphone. Hold the microphone one to two inches from the mouth and speak in a normal tone of voice. The TX indicator should be illuminated.
4. Release the PTT switch when the message is completed.

MONOGRAM SERIES LBI-38865

OPERATION

DIGITAL CHANNEL GUARD

Channel Guard provides a means of restricting calls to specific radios through the use of a continuous tone coded squelch system (CTCSS), or a multi-code digital squelch system (DCG). tone frequencies range from 67Hz to 250.3Hz. There are 83 standard programmable digital codes.

The Channel Guard tone frequencies and codes are software programmable. Both tone frequencies and digital codes may be mixed on each channel. The frequencies and codes are shown in Tables 1 and 2. A Channel Number display that does not flash, indicates that Channel Guard is enabled, or that Channel Guard is not programmed. A flashing Channel Number indicates that Channel Guard is programmed and disabled.

Table 1 - Channel Guard tone Frequencies

Standard Tone Frequencies in Hertz							
67.0	71.9	74.4	77.0	79.7	82.5	85.4	88.5
91.5	94.8	97.4	100.0	103.5	107.2	110.9	114.8
118.8	123.0	127.3	131.8	136.5	141.3	146.2	151.4
156.7	162.2	167.9	173.8	179.9	186.2	192.8	203.5
210.7	218.1	225.7	233.6	241.8	250.3		

Table 2 - Primary DCS Codes

DIGITAL SQUELCH CODES						
023	114	174	266	411	506	703
025	115	205	271	412	516	712
026	116	212	274	413	523	723
031	122	223	306	423	526	731
032	125	225	311	431	532	732
036	131	226	315	432	546	734
043	132	243	325	445	565	743
047	134	244	331	446	606	754
051	143	245	332	452	612	
053	145	246	343	454	624	
054	152	251	346	455	627	
065	155	252	351	462	631	
071	156	255	356	464	632	
072	162	261	364	465	654	
073	165	263	365	466	662	
074	172	265	371	503	664	

CIRCUIT ANALYSIS

RECEIVER

RF Amplifier

Incoming signals from the antenna jack are routed backwards through the transmitter lowpass filter in PIN diode switch D16. In receive mode, D16 conducts allowing a low impedance path through the diode to the receiver front end circuitry. The receiver RF amplifier section is comprised of two bandpass filter sections separated by an amplifier based around Q1. These two filters allow signals at or near the operating frequency to pass but provide strong rejection of the mixer's spurious response frequencies. The first filter section is a two pole design formed around RF helical resonator T1 and the associated circuitry. This filter is followed by the RF amplifier transistor Q1. This device with its low noise figure, yields good receiver sensitivity while showing strong resistance to overload from strong signals. The output of Q1 drives a pole filter section formed around T2 and T3. The output of the RF amplifier stage is routed to the first mixer.

First Mixer and First IF Amplifier

The action of the first mixer transistor Q2 is to convert incoming signals at the operating frequency to the frequency of the first IF which is 21.4 MHz. the output of the mixer is at a frequency which is equal to the difference between the frequency of the incoming signal and the local oscillator. In this radio, the local oscillator signal is chosen to be 21.4 MHz below the operating frequency. The device chosen to perform the mixing operation is Q2, a high performance JFET. The incoming signal is applied to the gate of Q2 while the local oscillator is applied to the drain. The local oscillator signal is filtered by Helical Resonator T6 and associated circuitry before being supplied to the drain of Q2. The difference frequency signal at 21.4 MHz exits the mixer at the source of Q2 and is tuned for 21.4 MHz by T8, which drives the first IF filter XF1 and XF2. XF1 and XF2 form a 4-pole monolithic crystal filter pair which in part determines the selectivity of the radio. The output of the crystal filter is routed to the first IF amplifier formed around Q3. RF transformer T9 provides proper matching of the crystal filters to insure good bandpass response and selectivity.

Second Mixer, Second IF, and FM Detector

The output of Q3 is applied to the input (pin 16) of IC2. IC2 is a single conversion FM receiver on one integrated circuit chip. The signal at the input is routed straight to a mixer which converts the incoming signal to the second IF frequency of 455 kHz. The second local oscillator is formed with crystal X1 and circuitry within IC2. The output of the second mixer is at pin 3 which is connected to a ceramic bandpass filter CF1 and centered at 455 kHz. This filter, along with XF1 and XF2, determine the adjacent channel selectivity of the radio. The output of CF1 drives a high gain IF amplifier chain internal to IC2 which in turn drives the quadrature detector. The output of the detector is amplified and exits IC2 at pin 9.

Audio

Detected audio from IC2 passes through a lowpass filter formed around L16, C64 and C65 which removes IF frequency components at 455 kHz. the audio signal then passes through buffer amplifier transistor Q7 before being filtered by a two section, 4-pole high pass filter (IC3). This filter removes DCS and CTCSS low frequency tones from the recovered audio. Transistors Q6 and Q108 act as switches around volume control VR2 to mute the audio during squelched receive operation. The audio signal is finally routed to audio power amplifier IC103 and then to the speaker.

MONOGRAM SERIES LBI-38865

CIRCUIT ANALYSIS

Squelch

The presence of an RF carrier is determined by noting the level of ultrasonic noise at the detector output (pin9) of IC2. When a carrier is present, the noise level drops. The audio at pin 9 of IC2 is filtered by a two-pole bandpass filter formed around L17, L18, C68 and C69. This filter passes audio at and near an audio frequency of 50 kHz. This frequency is high enough that voice audio and its harmonics will not cause improper squelch operation. The output of the filter is routed to an amplifier internal to IC2. The output of the amplifier drives Q4. The DC voltage at the detector output is amplified and filtered by Q4. The output of Q4 send its squelch signal to the microprocessor. When the microprocessor determines that a valid carrier exists, it sends an unmute signal to the audio switch transistors Q6 and Q108.

TRANSMITTER

Audio

The microphone audio is amplified, pre-emphasized and peak limited by circuits within IC113. The output of the limiter is routed through RV4, the microphone deviation control. Input CTCSS and DCS signals are routed through RV5, the CTCSS/DCS deviation control. Both signals are summed through a lowpass filter formed around IC114 to remove high frequency components from the limiter which could cause channel splatter. When the microprocessor enables the TX 8 volt supply, analog gate IC115 delivers the modulation signal to the VCO transistor Q115 by changing the capacitance of D123 and D110.

RF Driver and Power Amplifier

Diode D11 acts as a switch allowing the RF signal from the phase locked loop frequency synthesizer to pass through the RF driver and power amplifier during transmit, but not during receive. Buffer amplifier Q10 amplifies the carrier to the level needed by the driver amplifier stages. The driver amplifiers, of which the last 2 stages are gain controlled by the automatic power control, drive the final amplifier stage formed around Q14. The final amplifier boosts the carrier level to the power level set by the automatic power control. The carrier signal passes through the automatic power control directional coupler, the RF output lowpass filter, and then is routed to the antenna connector.

Automatic Power Control

The automatic power control directional coupler samples a portion of the forward RF power output to determine the RF level. Diode D15 rectifies this RF sample and produces a DC voltage which is proportional to the RF output level. This DC signal is summed with the voltage set from the power output control RV3. This voltage is compared with a voltage derived from the TX 8 volt supply and the difference is amplified by IC5. The output of the RF driver is proportional to its supply voltage. This controls the DC output of Q9, which supplies Q12 and Q13 controlling the output of Q14 over the range from 10 to 40 watts. This completes a negative feedback loop which results in constant output power over supply voltage and temperature variations.

FREQUENCY SYNTHESIZER

The phase locked loop (PLL) frequency synthesizer section is responsible for generating the RF signal at the carrier frequency during transmit and at the local oscillator frequency for the receiver during receive. A PLL functions by comparing the output frequency of a voltage controlled oscillator (VCO) with a fixed frequency reference. An error signal is generated which drives the control input of the voltage controlled oscillator to force its frequency to match the reference. The PLL based frequency synthesizer has a digital frequency divider inserted between the output of the VCO and the frequency comparison circuitry. As this divider number is varied, the output frequency of the VCO varies as well with a frequency step size equal to the reference frequency (6.25 kHz in this radio). This allows a large range of frequencies to be generated with one well controlled oscillator signal, the reference.

PLL Integrated Circuit

IC118 contains most of the digital circuitry to form a PLL frequency synthesizer. This includes a reference oscillator, programmable reference frequency divider, a programmable variable frequency divider, a modulus control

MONOGRAM SERIES LBI-38865

CIRCUIT ANALYSIS

counter, a phase/frequency comparator and a frequency lock detector. The operation of this integrated circuit is controlled by the radio's microprocessor through a serial data line.

Reference Oscillator

Crystal X2, varactor D122, a thermistor/resistor network and the oscillator stage of IC118 form a temperature compensated 12.8 MHz oscillator. This frequency is divided by 2048 to generate the 6.25 kHz frequency for the PLL frequency synthesizer. This reference determines the frequency stability of the overall radio.

Voltage Controlled Oscillator

Transistor Q115 and its associated circuitry form a voltage controlled oscillator which is voltage tuned and band switched by varactor diodes D123 and D110. the VCO output is buffered and isolated by Q117, Q118 and Q119. Audio modulation is applied to the cathodes of D123 and D110 to produce frequency modulation during transmit.

Dual Modulus Prescaler

The internal dividers within IC118 are not able to operate at the VCO output frequency. To alleviate this problem, part of the overall frequency division necessary between the VCO and the phase/frequency comparator is placed external to, and controlled by, IC118. IC117 divides the VCO frequency by 128 or 129, determined by the state of IC118 pin 6. This produces a lower frequency which can be further divided by IC108. By strategic timing when to divide by 128 or 129, the overall division will be that necessary to put the VCO on the correct frequency.

Loop Filter

Resistors R317 through R322 and capacitors C291, C294 and C295 form the loop filter. The purpose of the loop filter is to filter out the 6.25 kHz reference frequency products from the output of phase/frequency comparator IC118 and to determine the dynamic operation of the overall loop.

R316, C289, Q113 and Q114 act to speed up operation of the synthesizer loop during channel changes and during frequency transition (receive to transmit and transmit to receive).

Out-of-Lock Detector

IC118 contains a circuit which compares the timing difference of the 6.25 kHz reference frequency and the divided down VCO frequency. The output is a 6.25 kHz pulse whose duration is equal to the timing difference. R306 and C274 filter this pulse and average it producing a DC voltage which is proportional to the pulse width. When the loop is in lock, this voltage is zero, but when the loop is out of lock, it rises to a level which will forward bias Q112. The output of Q112 drives the microprocessor. The microprocessor will not allow the radio to transmit unless the synthesizer is in lock. This is to prevent out of band signals from being transmitted.

MONOGRAM SERIES LBI-38865

PREVENTIVE MAINTENANCE

PREVENTIVE MAINTENANCE

To ensure high operating efficiency and to prevent mechanical and electrical failures from interrupting system operations, routing checks should be made of all mechanical and electrical parts at regular intervals. Preventive maintenance should include the following checks:

CONNECTIONS

Ground connections to the voltage source should be periodically checked for tightness. Loose or poor connections to the power source will cause excessive voltage drops and faulty operation. When ground connections are not made directly to the batter, the connection from the battery to vehicle chassis must be checked for low impedance. A high impedance may cause excessive voltage drops and alternator noise problems.

ELECTRICAL SYSTEM

Check the voltage regulator and alternator or generator periodically to keep the electrical system within safe and economical operation limits. Over voltage is indicated when the battery loses water rapidly. Usage of 1 or 2 ounces of water per cell per week is acceptable for batteries in continuous operation. A weak battery will often cause excessive noise or faulty operation.

MECHANICAL INSPECTION

Since mobile units are subject to constant shock and vibration, check for loose plugs, nuts, screws and other parts to make sure that nothing is working loose.

ANTENNA

The antenna, antenna base and all contacts should be kept clean and free from corrosion. If the antenna or its base should become coated or poorly grounded, loss of radiation and a weak signal will result.

ALIGNMENT

The transmitter and receiver meter readings should be checked periodically, and the alignment "touched up" when necessary. Refer to the Alignment Procedure in this Service Manual.

FREQUENCY CHECK

Check the transmitter frequency and deviation. Normally, these checks are made when the unit is first put into operation, after the first six months, and once a year thereafter.

MONOGRAM SERIES LBI-38865

DISASSEMBLY

DISASSEMBLY

TOP AND BOTTOM COVERS

There are no screws used to secure the top and bottom covers. Both top and bottom covers are removed with a flat blade screwdriver or similar tool. On each side of the radio there are two small slots (one at the top and one at the bottom). Insert the screwdriver into the slot and gently pry the lip of the cover out from the radio. Without removing the screwdriver from the slot and in the same motion, pry the cover up. Both covers can be removed from either side of the radio.

FRONT PANEL

1. Remove the (6) M3 x 6 machine screws (3 on top and 3 on bottom) that secure the front panel to the chassis.
2. Two cables connect the volume board to the RF board (at PL1) and to the digital board at (PL2). These cables may be unplugged at the RF board and at the digital board. A ribbon cable from the display board to the digital board must be unplugged to remove front panel.

RF BOARD

1. Remove the (13) M3 x 24 machine screws securing the RF shield to the chassis.
2. Remove the M3 x 8 machine screw that secures the DC cord bracket to the chassis. Slide the bracket and cord out of the chassis.
3. Remove the (6) M3 x 6 machine screws (3 on top and 3 on bottom) that secure the front panel to the chassis.
4. Remove the RF shield by pushing the front panel forward so the shield will clear and then sliding the DC cord, bracket and connector through the rectangular hole in the shield.
5. De-solder the antenna connector from the RF board.
6. Remove the remaining (10) machine screws securing RF board, IC1, and Q14 and Q9.
7. Q13 is mounted to the chassis with a spanner nut which is only accessible from top of the radio through a hole in the digital board. Remove the spanner nut.
8. Remove the RF board.

MONOGRAM SERIES LBI-38865

DISASSEMBLY

DIGITAL BOARD

1. Remove the (6) M3 x 18 machine screws that secure the top panel shield to the chassis.
2. Unplug and remove the Auxiliary Relay PCB at PL5.
3. Remove the (6) machine screws (3 on top and 3 on bottom) that secure the front panel to the chassis.
- *The following steps detail the removal of the RF shield which is necessary before continuing with the removal of the digital board.*
4. Remove the (13) M3 x 24 machine screws securing the RF shield to the chassis.
5. Remove the M3 x 8 machine screw that secure the DC cord bracket to the chassis. Slide the bracket and cord out of the chassis.

6. Remove the RF shield by pushing the front panel forward so the shield will clear and then sliding the DC cord, bracket and connector through the rectangular hole in the shield.
7. Unplug the VCO cable from the jack.
8. Remove the remaining (10) screws securing the digital board, IC5, IC6 and IC104 to the chassis.
9. The digital board can now be removed from the chassis, however the front panel assembly is still attached by two cables (one from the Control board and one from the display board). The cable from the Control board at PL2 may be unplugged. The ribbon cable from digital board may be unplugged at FLT.

MONOGRAM SERIES LBI-38865

PROGRAMMING INSTRUCTION

PROGRAMMING INSTRUCTION

The UHF synthesized mobile radio is equipped with a personality EEPROM. All customer information such as the customer frequencies, customer tones and customer options are stored in the EEPROM. The EEPROM contains all information to tailor the operation of the radio to the user's requirements. The EEPROM is programmed by using an IBM compatible personal computer with MSDOS, Programming Cable TQ-3376 and Programming software TQ-3375.

PROGRAMMING THE RADIO

The Programming Cable TQ-3376 is a Y-cable. The base of the "Y" has a standard 25 pin connector which plugs into the computer, the remaining end has a 6 pin connector which fits into the connector PL1 on the digital board inside the radio. To use this cable, remove the top cover of the radio as described in the DISASSEMBLY section. Plug the six pin connector into the socket inside the radio (PL1), which is located near the EEPROM IC107. Plug the base of the "Y" into the computer that will program the radio. See the diagram in TQ-3375 Software Manual. In order to program the radio with the programming cable, it is necessary to put the radio into the programming mode. To do this, press the **P** "PRIORITY" button/LED on the radio and turn the radio ON. The radio will sound a prompt tone and show the words "PROG" on the display. Please refer to the Software Manual for further instructions on the operation of the Programming Software. After completing the programming instructions in the Manual, remove the cable from PL1 and replace the cover on your UHF synthesized mobile radio.

MONOGRAM SERIES LBI-38865

TEST EQUIPMENT SETUP

TEST EQUIPMENT SETUP

TRANSMITTER

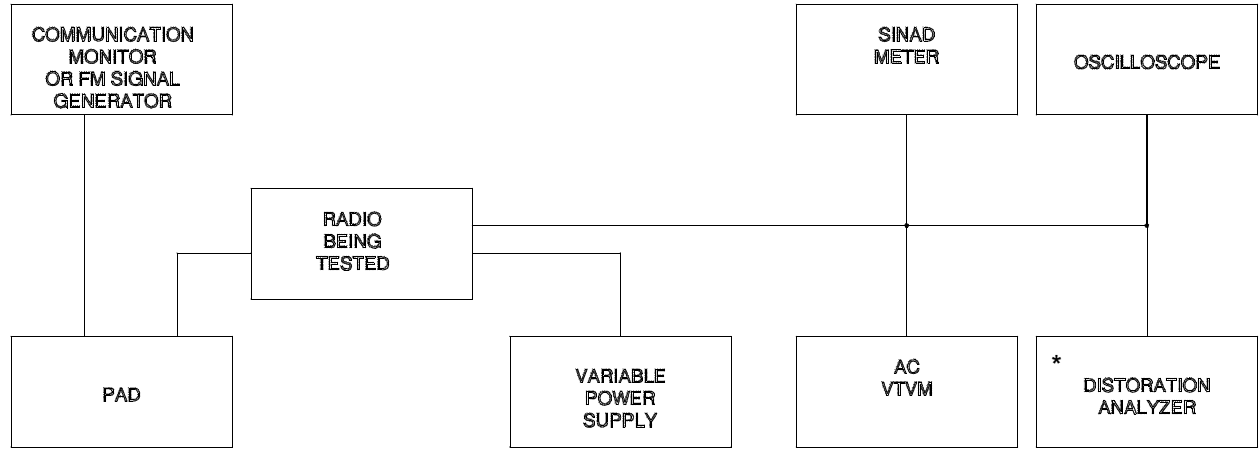
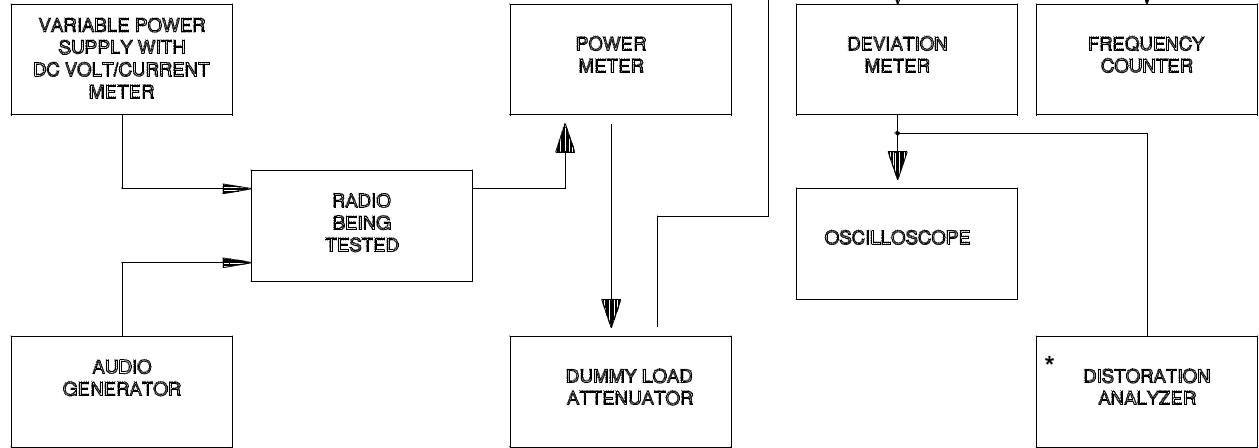

RECEIVER

* = OPTIONAL TEST EQ.

MONOGRAM SERIES LBI-38865

ALIGNMENT PROCEDURE

ALIGNMENT PROCEDURE

SUGGESTED TEST EQUIPMENT

- **WARNING:** Any repairs or adjustments should be made under the supervision of a certified technician.

The following equipment, or its equivalent, is required for proper alignment of the UHF synthesized mobile radio:

1. Termlane watt meter or Through-line watt meter with termination into 50 ohm dummy load.
2. AC/DC VOM with a minimum of 1 Megohm input impedance.
3. SINAD Meter.
4. FM Communications Monitor.
5. Regulated power supply capable of 9 to 16 volts adjustable; at least 10 ampere capability.
6. Oscilloscope.
7. Audio Distortion Meter (desirable but not necessary).
8. Frequency Counter.

PROGRAMMING FOR ALIGNMENT

For the alignment procedures the EEPROM should be programmed as follows:

1. An EEPROM should be programmed with 3 transmit and 3 receive frequencies.
2. The lowest and highest frequencies should enclose the user's frequencies and be 10 MHz apart. The lowest and highest frequencies must be within the appropriate frequency band.
3. In addition to programming frequencies, CTCSS and DCS codes must also be programmed to insure that the modulation deviation for these potential options is correct, even if they are not to be used for the customer's operation. The following format should be used:

Lowest RX/TX frequency	67.0Hz CTCSS Tone
Middle RX/TX frequency	DCS Code 072
Highest RX/TX frequency	250.3Hz CTCSS Tone
Highest RX/TX frequency	No Tone Options

MONOGRAM SERIES LBI-38865

ALIGNMENT PROCEDURE

4. The middle RX/TX frequencies should be halfway between the lowest and the highest frequencies.
- **NOTE: There should be 4 channels programmed with a total of 3 different frequencies.**
5. The highest transmit frequency can typically be only 10 MHz above the lowest receiver frequency.

PLL ALIGNMENT

1. Connect an RF dummy load or power attenuator (50 watt minimum rating) to the antenna receptacle.
2. Connect a VOM or DVM to TP1, accessed through a hole in the VCO cover.
3. Set the CHANNEL selector to the lowest receive frequency.
4. Adjust TC13 setting the voltage measured at TP1 to 1.5 volts (± 0.05).
5. Change the CHANNEL selector to the highest transmit frequency.
6. Press the PTT switch. The VOM should read less than 7.5 volts.
7. Release the PTT switch.

CHANNEL	TP1 VOLTAGE	
	TRANSMIT	RECEIVE
Lowest Frequency	1.5 VDC	2.0 VDC
Highest Frequency	7.5 VDC	7.0 VDC

TRANSMITTER ALIGNMENT

1. Connect a 50 ohm RF dummy load or a power attenuator (50 watt minimum rating) through a watt meter (50 watt scale) to the antenna receptacle.
2. Turn RV2 (Automatic power adjustment) fully clockwise.
3. Connect variable DC power supply (10 Ampere capability) to the DC power cable on the radio. Set the voltage to 13.8 VDC measured at the radio during transmit. (Voltage drops in the power cable during transmit will lower the voltage at the radio).
4. Set the CHANNEL selector to a mid-frequency transmit channel.
5. Press the PTT switch.
- **NOTE: The power output may exceed 50 watts.**
6. Adjust RV2 for 40 watts, or the desired power output. (10 - 40 watts). Release the PTT switch.

MONOGRAM SERIES LBI-38865

ALIGNMENT PROCEDURE

- **WARNING:** To prevent damage to the radio, avoid keying the radio for periods longer than 1 minute. Allow a 5 minute cool down period after keying the radio for 1 minute.

7. Check the power output at the lowest, middle and highest transmit channels and adjust RV2 if necessary, to maintain 40 watts at all frequencies.
8. Press PTT and adjust TC11 for the correct frequency.

DCS Modulation Balance Adjustment

1. Connect test equipment to the radio as shown in the Test Equipment Setup.
 2. Set the CHANNEL selector to a transmit channel which has a DCS code pre-programmed (should be mid-frequency channel).
- **WARNING:** The power attenuator must have enough attenuation to prevent damage to the deviation meter.
3. Press the PTT switch.
 4. Observe the waveform on the oscilloscope and compare with that shown in Figure 6.
 5. Adjust RV5 and TC12 to achieve the proper wave form. Release the PTT switch.

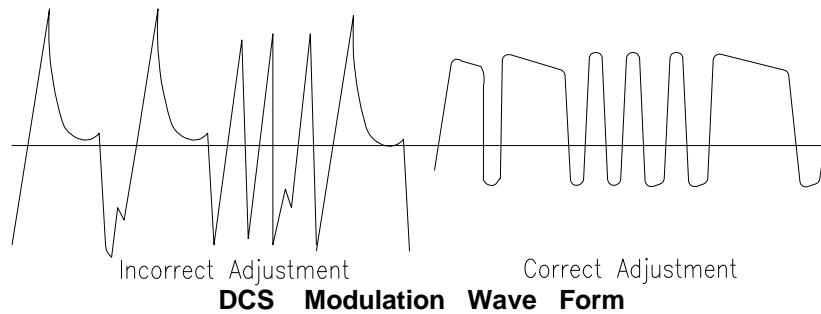

6. Replace the deviation meter with a frequency counter.
 7. Set the CHANNEL selector to the highest transmit channel. Ensure that this channel has no DCS or CTCSS tones pre-programmed.
 8. Press PTT switch. Adjust TC11 for the correct transmit frequency. Release the PTT.
- **NOTE:** TC12 should not be allowed to be placed at the maximum capacitance position, if TC12 should be found to be at the maximum capacitance position, place TC12 at the typical position and adjust RV5 for the proper wave form.

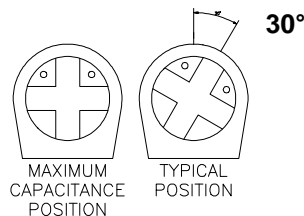

TC12 Maximum capacitance position and typical position

MONOGRAM SERIES LBI-38865

ALIGNMENT PROCEDURE

Modulation Deviation Adjustment

1. Connect an RF deviation meter to the radio through a power attenuator.
2. Set the CHANNEL selector to a transmit channel which has a DCS code pre-programmed (should be a mid-frequency channel).
3. Press the PTT switch.
4. Adjust RV3 for proper deviation, typically 750Hz. Release the PTT switch.
5. Set the CHANNEL selector to a transmit channel which has a low-frequency CTCSS tone (67.0Hz) pre-programmed.
6. Press the PTT switch and verify that the deviation is between 500Hz and 1000Hz. Release the PTT switch.
7. Set the CHANNEL selector to a transmit channel which has a high-frequency CTCSS tone (250.3Hz) pre-programmed.
8. Press the PTT switch and verify that the deviation is between 500Hz and 1000Hz. Release the PTT switch.
 - a. If deviation level is not that obtained in Step 6 adjust RV 401 to same level.
9. Connect an audio frequency generator to the MIC input (connected to the white wire in the microphone cable) of the radio. Set the audio output level for 30 mV. the audio frequency should be 1 kHz.
10. Press the PTT switch.
11. Adjust RV4 (maximum deviation adjustment) for the 4.2 kHz deviation if no CTCSS tones are present, and 4.9 kHz deviation if CTCSS tones are present.

RECEIVER ALIGNMENT

1. Connect an RF signal generator or communications service monitor to the antenna receptacle.
2. Connect a SINAD meter and an audio distortion analyzer across the speaker terminals. If an audio distortion analyzer is not available, connect an oscilloscope across the speaker terminals.
3. Turn the SQUELCH control fully counter-clockwise.
4. Adjust the VOLUME control to the proper level for the SINAD meter and audio distortion analyzer.
5. Set the CHANNEL selector to a mid-frequency receive channel.
6. Tune the RF signal generator to the channel frequency. the RF output level should be set for -47 dBm. The modulation should be set for ± 3 kHz FM deviation of a 1 kHz tone.
7. Adjust T10 for maximum audio output. Readjust the VOLUME control if necessary to avoid clipping on the output audio wave form. (This adjustment is typically not required.)
8. Decrease the RF generator output and adjust T1 through T9 for maximum sensitivity.
9. Check the sensitivity at the lowest and highest receive frequencies. If necessary, repeat steps (8) and (9) above at the lowest middle and highest frequencies for the best overall sensitivity.

MONOGRAM SERIES LBI-38865

ALIGNMENT PROCEDURE

Receiver Squelch Adjustment

1. Set the channel selector for the mid frequency receive channel.
 2. Connect an RF signal generator or communications service monitor to the antenna receptacle. The modulation should be set for ± 3 kHz FM modulation of a 1kHz tone. The RF output level should be at a minimum.
 3. Adjust the SQUELCH control to the threshold point (the point where the speaker audio disappears).
 4. Increase the RF signal generator output level until speaker audio output reappears. Note the generator level.
 5. Turn the SQUELCH control fully clockwise.
 6. Increase the RF signal generator level by 16 dB.
- *NOTE: This squelch adjustment procedure is very important for the correct operation of the microprocessor aided squelch system.*

MONOGRAM SERIES LBI-38865

RF BOARD ALIGNMENT AND TEST POINTS

RF BOARD ALIGNMENT AND TEST POINTS

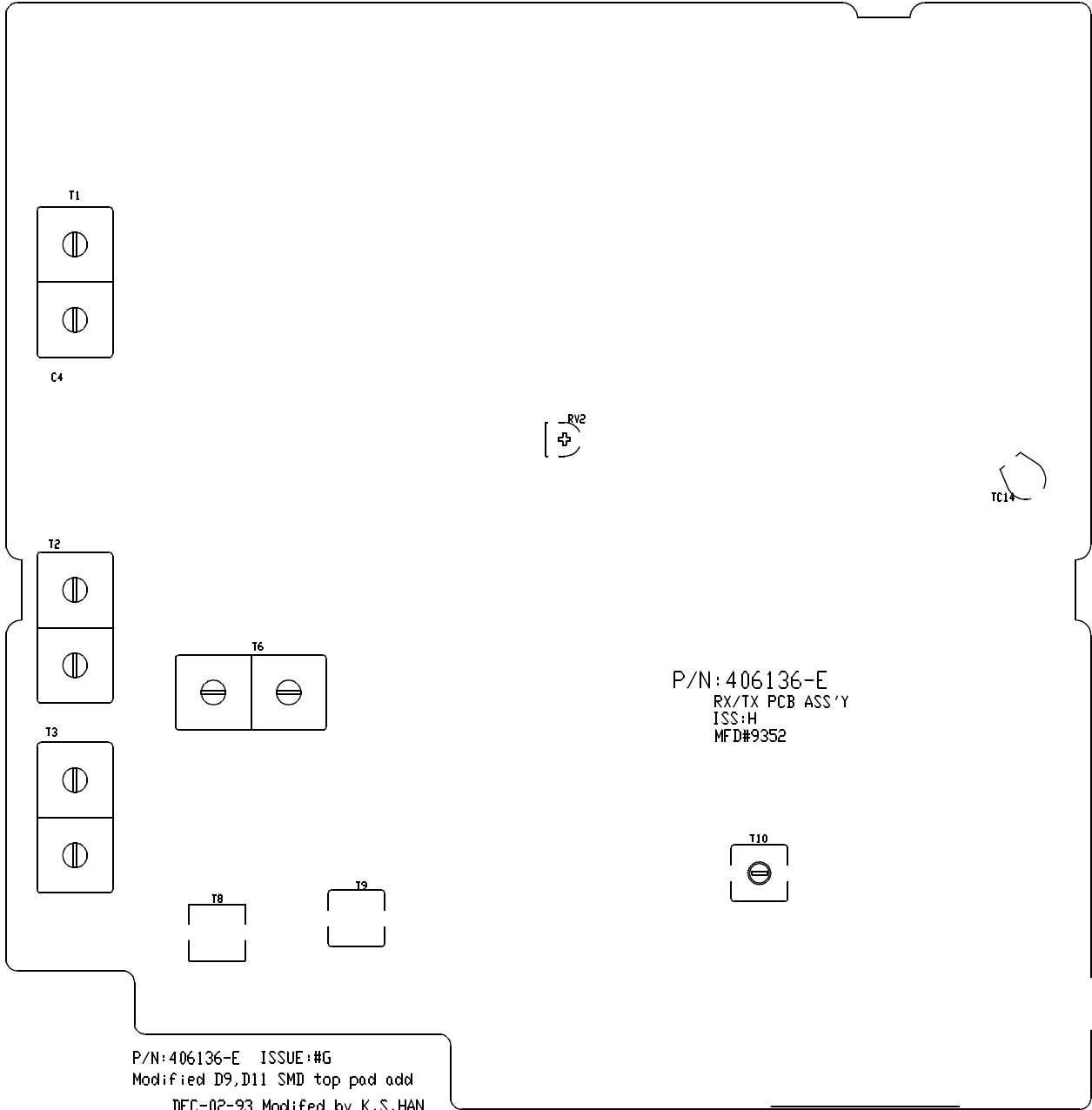

MONOGRAM SERIES LBI-38865

DIGITAL BOARD ALIGNMENT AND TEST POINTS

DIGITAL BOARD ALIGNMENT AND TEST POINTS

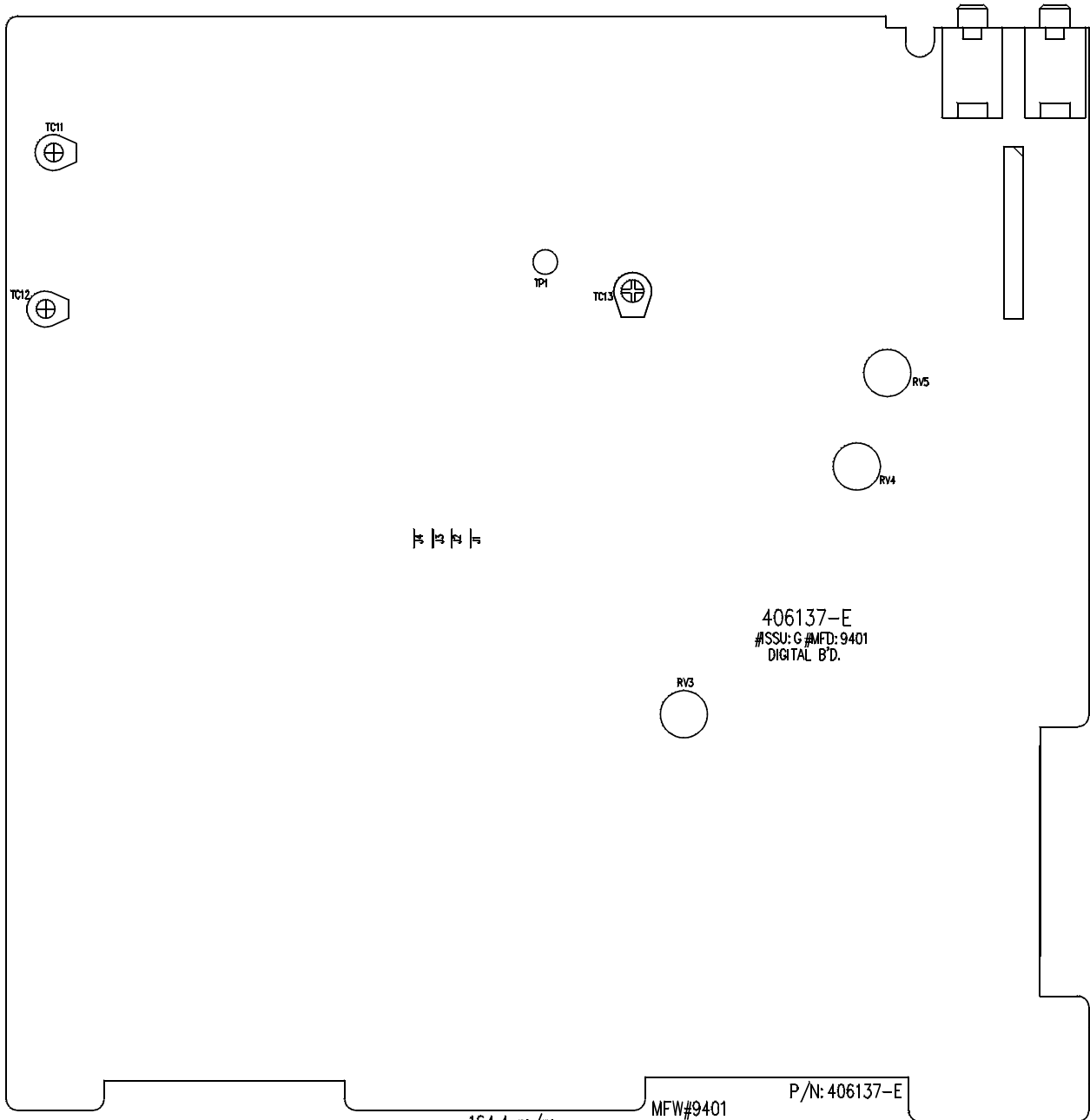

ISSU: G [Parts add.(C360,C361,C362,C363,R360)] [Top/Bot,X-tal soldermask add.]

MONOGRAM SERIES LBI-38865

PERFORMANCE TEST

PERFORMANCE TEST

TRANSMITTER PERFORMANCE TEST

Power Output

1. Set the power supply voltage to 13.8 VDC (measured at the radio during transmit).
2. Connect an RF watt meter and dummy load to the antenna receptacle.
3. Press the PTT switch.
4. Verify that the output is at least 40 watts.
5. Reduce the power supply voltage to 11 volts.
6. Verify that the output is at least 15 watts.
7. Release the PTT switch.

Audio Response

1. Connect an audio generator to the microphone jack on the radio. Set the generator for a frequency of 1 kHz.
2. Connect a communication service monitor to the RF output of the radio through a power attenuator. Set the monitor to read average peak FM deviation.
3. Press the PTT switch.
4. Adjust the audio generator level to produce 1 kHz deviation.
5. Set the audio generator frequency to 2 kHz. The transmitter deviation should be approximately 2 kHz.
6. As the audio generator frequency is varied from 300Hz to 10 kHz, the deviation should increase until it reaches a maximum at an audio frequency of 2.5 kHz to 2.9 kHz. At higher frequencies, the deviation should decrease. the deviation at an audio frequency of 6 kHz should be less than 1 kHz.
7. Release the PTT switch.

Limiting Test

1. Set the audio generator frequency to 1 kHz.
2. Press the PTT switch and adjust the generator level to produce 1 kHz deviation. Note the generator level.
3. Increase the audio generator level by 20 dB (factor of 10 times).
4. Sweep the audio generator over a frequency range of 300Hz to 3 kHz. the deviation should not exceed ± 1 kHz within this range.
5. Release the PTT switch.

MONOGRAM SERIES LBI-38865

PERFORMANCE TEST

Spectrum Test

1. Connect a spectrum analyzer to a sampled RF output of the radio.
2. Press the PTT switch. Observe the output spectrum on the spectrum analyzer.
3. All spurious and harmonics should be at least 60 dB below the carrier level.
4. Release the PTT switch.

RECEIVER PERFORMANCE TESTS

SINAD Sensitivity

1. Connect the FM signal generator of communication service monitor to the antenna jack.
2. Connect a SINAD meter across the speaker leads.
3. Turn the SQUELCH control fully counterclockwise for maximum noise.
4. Adjust the VOLUME control to approximately mid-range.
5. Set the FM signal generator or service monitor to the receive frequency. The modulation should be set for 3 kHz deviation of a 1 kHz tone.
6. Adjust the generator RF level so that the SINAD meter reads 12 dB. The signal generator RF level should be .35 uV or less.

Noise Quieting Sensitivity

1. Connect a VOM to the speaker leads.
2. Turn the SQUELCH control fully counterclockwise for maximum noise.
3. With no RF signal generator or communication service monitor connected to the radio, adjust the VOLUME control to obtain a noise reading of 1 volt RMS on the VOM.
4. Connect the RF signal generator or service monitor to the radio. Set the RF frequency to the receiver frequency of radio and remove any modulation.
5. Adjust the signal generator RF level for a noise reading on the VOM of 0.1 volt RMS. This is the 20 dB noise quieting point. the RF level should be 0.5 uV or less.

Squelch Sensitivity

1. Set the RF signal generator or service monitor to the receive frequency. Set the modulation to 3 kHz deviation of a 1 kHz audio tone.
2. Reduce the signal generator RF output to zero.
3. Rotate the SQUELCH control clockwise to the point where the speaker noise just goes away.
4. Increase the signal generator or service monitor RF level until the speaker noise returns. This is the threshold squelch setting. The generator output level should not exceed 0.20 uV.
5. Turn the SQUELCH control to maximum clockwise rotation.
6. Increase the generator output level until the squelch opens (busy LED is on). The output level should be between 10 and 20 dB (3 to 10 times) above the threshold setting.

MONOGRAM SERIES LBI-38865

PERFORMANCE TEST

Audio Output

1. Increase the RF signal generator or service monitor RF level to 1000 uV.
2. Connect a 4 ohm audio dummy load to the AUXILIARY speaker jack.
3. Connect a true RMS audio voltmeter (the audio distortion analyzer may include this function) to the speaker leads.
4. With a 3 kHz deviation of a 1 kHz tone modulation applied to the signal generator, rotate the VOLUME control clockwise until the audio distortion is 10% or until the VOLUME controls reaches stop, whichever comes first.
5. The audio voltmeter should read 4.0 volts or greater.

MONOGRAM SERIES LBI-38865

COMPONENT REPLACEMENT

COMPONENT REPLACEMENT

SURFACE MOUNT COMPONENTS

Surface mount components should always be replaced using a temperature controlled soldering system. The soldering tools may be either a temperature controlled soldering iron or a temperature controlled hot-air soldering station. A hot-air system is recommended for the removal of components on the multi-layered boards used in the UHF synthesized mobile radio. With either soldering system, a temperature of 700°F (371°C) should be maintained.

The following procedures outline the removal and replacement of surface mount components. If a hot-air soldering system is employed, see the manufacture's operating instructions for detailed information on the use of your system.

- **CAUTION:** *Avoid applying heat to the body of any surface mount component using standard soldering methods. Heat should be applied only to the metallized terminals of the components. Hot-air systems do not damage the components since the heat is quickly and evenly distributed to the external surface of the component.*
- **CAUTION:** *The CMOS Integrated Circuit devices used in this equipment can be destroyed by static discharges. Before handling one of these devices, service technicians should discharge themselves by touching the case of a bench test instrument that has a 3-prong power cord connected to an outlet with an known good earth ground. When soldering or desoldering a CMOS device, the soldering equipment should have a known good earth ground.*

SURFACE MOUNT REMOVAL

1. Grip the component with tweezers or small needle nose pliers.
2. Alternately heat the metallized terminal ends of the surface mount component with the soldering iron. If a hot-air system is used, direct the heat to the terminals of the component. Use extreme care with the soldering equipment to prevent damage to the printed circuit board (PCB) and the surrounding components.
3. When the solder on all terminals is liquefied, gently remove the component. Excessive force may cause the PCB pads to separate from the board if all solder is not completely liquefied.
4. It may be necessary to remove excess solder using a vacuum de-soldering tool or Solder wick. Again, use great care when de-soldering on the printed circuit boards. it may also be necessary to remove the epoxy adhesive that was under the surface mount component and any flux on the printed circuit board.

SURFACE MOUNT COMPONENT REPLACEMENT

1. "Tin" one terminal end of the new component and the corresponding pad of the PCB. Use as little solder as possible.
2. Place the component on the PCB pads, observing proper orientation for capacitors, diodes, transistors, etc.
3. Simultaneously touch the "tinned" terminal end and the "tinned" pad with the soldering iron. Slightly press the component down on the board as the solder liquefies. Solder all terminals, allowing the component time to cool between each application of heat. Do not apply heat for an excessive length of time and do not use excessive solder. With a hot-air system, apply hot air until all "tinned" areas are melted and the component is seated in place. It may be necessary to slightly press the component down on the board. Touch-up the soldered connections with a standard soldering iron if needed. do not use excessive solder.
4. Allow the component and the board to cool and then remove all flux from the area using alcohol or another approved flux remover.

MONOGRAM SERIES LBI-38865

COMPONENT REPLACEMENT

SURFACE MOUNTED INTEGRATED CIRCUIT REPLACEMENT

- *CAUTION: Some chemicals may damage the internal and external plastic parts of the radio.*

Soldering and de-soldering techniques of the surface mounted IC's are similar to the above outlined procedures for the surface mounted chip components. Use extreme care and observe static precautions when removing or replacing the defective (or suspect) IC's. this will prevent any damage to the printed circuit board or the surrounding circuitry.

The hot-air soldering system is the best method of replacing surface mount IC's can easily be removed and installed using the hot-air system. See the manufacturers instructions for complete details on tip selection and other operating instructions unique to your system.

If a hot-air system is not available, the service technician may wish to clip the pins near the body of the defective IC and remove it. the pins can then be removed from the PCB with a standard soldering iron and tweezers, and the new IC installed following the Surface Mount Component Replacement procedures. It may not be necessary to "tin" all (or any) of the IC pins before the installation process.

ELECTRICAL PARTS LIST

NOTE

Only those items indicated by shading will be stocked by After Market Services. All other items are for reference only.

When ordering parts for your Monogram Series radio, precede all part numbers with the prefix "R29/"

PART NO.	DESCRIPTION	SYMBOL
	TANTALUM DIP 0.1UF, 16WV (AUDIO RELAY PCB)	C1
	CAP, TANTALUM 4.7UF, (RF PCB)	C1
	CERAMIC AXIAL 100PF	C2
	CAP, CERAMIC DISK 10PF	C3
	CAP, CERAMIC 5.6PF	C4
	CAP, CERAMIC DISK 12PF	C5
	CERAMIC AXIAL 220PF	C6
	CAP, ELECTROLYTIC 10UF, 16V	C8
	CAP, CERAMIC AXIAL 0.001UF	C9
	CERAMIC AXIAL 220PF	C10
	CAP, CERAMIC AXIAL 0.001UF	C11
	CERAMIC AXIAL 220PF	C12
	CAP, CERAMIC 10PF	C13
	CAP, CERAMIC AXIAL 0.01UF	C14
	CAP, CERAMIC AXIAL 0.001UF	C15
	CAP, CERAMIC AXIAL 0.001UF	C16
	CAP, CERAMIC AXIAL 0.001UF	C17
	CAP, CERAMIC AXIAL 0.001UF	C18
	CERAMIC AXIAL 220PF	C19
	CERAMIC AXIAL 220PF	C20
	CAP, MYLAR .0022UF, 50WV +/-5% MINI SIZE	C21
	CAP, ELECTROLYTIC 4.7UF, 16V	C22
	CAP, ELECTROLYTIC 10UF, 16V	C23
	CAP, MYLAR 0.1UF, 50WV +/-10% MINI SIZE	C24
	CERAMIC AXIAL 0.047UF	C25
	CAP, ELECTROLYTIC 22UF, 16V	C26
	CAP, TANTALUM 2.2UF, 16WV	C27
	CAP, CERAMIC AXIAL .001UF	C28
	CAP, CERAMIC AXIAL .001UF	C29
	CAP, CERAMIC AXIAL .001UF	C30
	CAP, TANTALUM 1.0UF, 16WV	C31
	CAP, CERAMIC AXIAL .001UF	C31
	CAP, TANTALUM 0.1UF, 16WV	C32
	CERAMIC AXIAL 220PF	C34
	CAP CHIP 220PF	C35
	CAP, ELECTROLYTIC 47UF, 10V	C36
	CERAMIC AXIAL 220PF	C37
	CAP, ELECTROLYTIC 100 UF, 25V	C38
	CERAMIC AXIAL 220PF	C39
	CAP, CERAMIC AXIAL .001UF	C40
	CAP, CERAMIC AXIAL .001UF	C41
	CERAMIC AXIAL 220PF	C42
	CAP, ELECTROLYTIC 47UF, 16V	C43
	CERAMIC AXIAL 220PF	C45
	CAP, ELECTROLYTIC 47UF, 16V	C46

PART NO.	DESCRIPTION	SYMBOL
	CERAMIC AXIAL 220PF	C47
	CERAMIC AXIAL 220PF	C48
	CERAMIC AXIAL 100PF	C49
	CERAMIC AXIAL 220PF	C50
	CERAMIC AXIAL 220PF	C51
	CERAMIC AXIAL 220PF	C52
	CAP, CERAMIC AXIAL .001UF	C53
	CAP, CERAMIC 39PF	C54
	CAP, 100PF	C55
	CAP, MULTILAYER CERAMIC .1UF,50V	C56
	CAP, MULTILAYER CERAMIC .1UF,50V	C57
	CAP, MULTILAYER CERAMIC .1UF,50V	C58
	CAP, CERAMIC AXIAL 0.001UF	C59
	CAP, CERAMIC DISK 12PF	C60
	CAP, ELECTROLYTIC 10UF, 16V	C61
	CAP, CERAMIC 56PF	C62
	CAP, MYLAR 0.1UF, 50WV +/-10% MINI SIZE	C63
	CAP, CERAMIC AXIAL 0.001UF	C64
	CAP, MYLAR 0.01UF, 50WV +/-10% MINI SIZE	C65
	CAP, MYLAR 0.01UF, 50WV +/-10% MINI SIZE	C66
	CAP, MYLAR 0.0068UF, 50WV +/-5% MINI SIZE	C67
	CAP, MYLAR 0.0039UF, 50WV +/-5% MINI SIZE	C68
	CAP, MYLAR 0.0068UF, 50WV +/-5% MINI SIZE	C69
	CAP, CERAMIC AXIAL 0.001UF	C70
	CAP, CERAMIC AXIAL 0.001UF	C71
	CAP, CERAMIC AXIAL 0.01UF	C72
	CAP, CERAMIC AXIAL 0.001UF	C73
	CAP, ELECROLYTIC 10UF, 16V	C74
	CAP, MYLAR 0.047UF, 50WV +/-10% MINI SIZE	C75
	CAP, MYLAR 0.047UF, 50WV +/-10% MINI SIZE	C76
	CAP, CERAMIC AXIAL 0.01UF	C77
	CAP, ELECTROLYTIC 10UF, 16V	C78
	CAP, MYLAR 0.047UF, 50WV +/-10% MINI SIZE	C79
	CAP, MYLAR 0.047UF, 50WV +/-10% MINI SIZE	C80
	CAP, ELECTROLYTIC 47UF, 10V	C81
	CAP, CERAMIC AXIAL 0.001UF	C82
	CAP, ELECTROLYTIC 47UF, 10V	C83
	CAP CHIP 220PF	C84
	CAP, CERAMIC CHIP 100PF	C85
	CERAMIC AXIAL 220PF	C86
	CAP CHIP 220PF	C87
	CAP, CERAMIC CHIP 100PF	C88
	CERAMIC AXIAL 220PF	C89
	CAP, ELECTROLYTIC 47UF, 10V	C90
	CERAMIC AXIAL 100PF	C91

PART NO.	DESCRIPTION	SYMBOL
	CAP, CERAMIC AXIAL 0.001UF	C92
	CAP, CERAMIC CHIP 51PF	C94
	CAP, CHIP 0.001UF	C95
	CERAMIC AXIAL 220PF	C96
	CERAMIC AXIAL 220PF	C97
	CAP, MYLAR 0.01UF, 50WV +/-10% MINI SIZE	C98
	CAP CHIP 220PF	C99
	CERAMIC AXIAL 220PF	C100
	CAP, ELECTROLYTIC 220UF, 16V	C101
	CAP CHIP 220PF	C102
	CAP, CERAMIC MONOLITHIC 5.6PF	C103
	CERAMIC CHIP 100PF	C104
	CAP, ELECTROLYTIC 1000UF 25V	C105
	CERAMIC AXIAL 220PF	C106
	CAP CHIP 220PF	C107
	CAP, CERAMIC AXIAL 0.001UF	C108
	CERAMIC AXIAL 220PF	C109
	CAP, CERAMIC CHIP 39PF	C110
	CAP, CERAMIC CHIP 5PF	C111
	CAP, CERAMIC MONOLITHIC 22PF	C112
	CAP, CERAMIC CHIP 36PF	C113
	CAP, CERAMIC CHIP 5PF	C114
	CERAMIC CHIP 24PF	C115
	CAP, CERAMIC CHIP 5PF	C116
	CAP, CERAMIC CHIP 220PF	C117
	CAP, CERAMIC CHIP 100PF	C118
	CERAMIC CHIP 27PF	C119
	CERAMIC CHIP 27PF	C120
	CAP CHIP 24PF	C121
	CAP CHIP 2PF	C122
	CAP, ELECTROLYTIC 100 UF, 25V	C123
	CAP, CERAMIC CHIP 100PF	C124
	CAP CHIP 220PF	C125
	CAP, CERAMIC CHIP 36PF	C126
	CAP, CERAMIC CHIP 36PF	C127
	CERAMIC MONOLITHIC GR111COG270	C130
	CAP MONOLITHIC GR111COG150	C131
	CAP MONOLITHIC GR111COG150	C132
	CAP, CERAMIC MONOLITHIC	C133
	CERAMIC MONOLITHIC GR111COG270	C136
	CERAMIC MONOLITHIC GR111COG270	C137
	CAP, CERAMIC 39PF	C138
	CAP, CERAMIC 33PF	C139
	CAP, MONOLITHIC GR111COG150	C140
	CERAMIC MONOLITHIC 10PF	C141

PART NO.	DESCRIPTION	SYMBOL
	CERAMIC MONOLITHIC 10PF	C142
	CAP, CHIP 0.001UF	C143
	CAP, CERAMIC CHIP 330PF	C144
	CAP, CERAMIC MONOLITHIC 3.9PF	C145
	CERAMIC MONOLITHIC 10PF	C146
	CERAMIC MONOLITHIC 10PF	C147
	CAP, CERAMIC MONOLITHIC 3PF	C148
	CAP CHIP 220PF	C149
	CAP, CERAMIC 39PF	C150
	CAP, CERAMIC CHIP 5PF	C151
	CAP, CERAMIC CHIP 5PF	C152
	CERAMIC AXIAL 220PF	C153
	CERAMIC AXIAL 220PF	C154
	CAP, CERAMIC AXIAL 0.01UF	C155
	CAP CHIP 220PF	C156
	CAP, CERAMIC 82PF	C157
	CERAMIC, CHIP 47PF	C158
	CAP, ELECTROLYTIC 1.0UF, 50V	C201
	CAP, CERAMIC AXIAL 0.001UF	C202
	CAP, CERAMIC AXIAL 0.01UF	C203
	CAP, CERAMIC AXIAL 0.01UF	C204
	CAP, ELECTROLYTIC 47UF, 25V	C205
	CAP, TANTALUM 1.0UF, 16WV	C206
	CAP, MYLAR 0.1UF, 50WV +/-10% MINI SIZE	C207
	CAP, CERAMIC AXIAL 0.01UF	C208
	CAP, ELECTROLYTIC 47UF, 16V	C209
	CAP, ELECTROLYTIC 22UF, 16V	C210
	CAP, CERAMIC AXIAL 0.001UF	C211
	CAP, ELECTROLYTIC 470UF, 16V	C212
	CAP, TANTALUM 0.1UF 16WV	C213
	CAP, TANTALUM 1.0UF, 16WV	C215
	CAP, ELECTROLYTIC 470UF, 16V	C216
	CAP, CERAMIC AXIAL 0.001UF	C217
	CAP, ELECTROLYTIC (AX)1000UF	C218
	CAP, MYLAR 0.1UF, 50WV +/-10% MINI SIZE	C219
	CAP, ELECTROLYTIC 10UF, 16V	C220
	CAP, CERAMIC AXIAL 0.001UF	C221
	CAP, ELECTROLYTIC 1.0UF, 16V	C222
	CAP, ELECTROLYTIC 1.0UF, 16V	C223
	CAP, ELECTROLYTIC 1.0UF, 16V	C224
	CAP, TANTALUM 10UF, 16WV	C225
	CAP, ELECTROLYTIC 470UF, 16V	C226
	CAP, MYLAR 0.1UF, 50WV +/-10% MINI SIZE	C227
	CAP, CERAMIC AXIAL 0.001UF	C228
	CAP, CERAMIC 30PF, 50WV	C229

PART NO.	DESCRIPTION	SYMBOL
	CAP, CERAMIC 30PF, 50WV	C230
	CAP, TANTALUM 10UF, 16WV	C231
	CAP, TANTALUM 6.8UF, 16WV	C232
	CAP, MYLAR 0.018UF 50V +/-15% MINI SIZE	C233
	CAP, MYLAR 0.033UF 50V +/-10% MINI SIZE	C234
	CAP, MYLAR 0.0018UF, 50WV +/-5% MINI SIZE	C235
	CAP, MYLAR 0.047UF, 50WV +/-10% MINI SIZE	C236
	CAP, POLY 820PF, 50WV	C237
	CAP, TANTALUM 4.7UF, 16WV	C238
	CAP, CERAMIC DISK 470PF, 50WV	C239
	CAP, TANTALUM 10UF, 16WV	C240
	CAP, TANTALUM 10UF, 16WV	C241
	CAP, MYLAR 0.0056UF, 50WV +/-5% MINI SIZE	C242
	CAP, MYLAR 0.047UF, 50WV +/-10% MINI SIZE	C243
	CAP, CERAMIC 68PF	C244
	CAP, TANTALUM 4.7UF, 16WV	C245
	CAP, MYLAR 0.018UF, 50WV +/-5% MINI SIZE	C246
	CAP, MYLAR 0.0056UF, 50WV +/-5% MINI SIZE	C247
	CAP, TANTALUM 10UF, 16WV	C248
	CAP, MONOLITHIC 220PF	C249
	CAP, MONOLITHIC 220PF	C250
	CAP, MONOLITHIC 220PF	C251
	CAP, MONOLITHIC 220PF	C252
	CAP, MYLAR 0.018UF, 50WV +/-2% MINI SIZE	C253
	CAP, CERAMIC AXIAL 0.001UF	C254
	CAP, CERAMIC AXIAL 0.001UF	C255
	CAP, CERAMIC AXIAL 0.01UF	C256
	CAP, ELECTROLYTIC 10UF, 16V	C257
	CAP, CERAMIC 56PF	C258
	CAP, MYLAR 0.015UF, 50WV +/-10% MINI SIZE	C259
	CAP, ELECTROLYTIC 47UF, 10V	C260
	CAP, ELECTROLYTIC 10UF, 16V	C261
	CAP, CERAMIC 56PF	C262
	CAP, ELECTROLYTIC 22UF, 16V	C263
	CAP, ELECTROLYTIC 47UF, 10V	C264
	CAP, MYLAR 0.0068UF, 50WV +/-5% MINI SIZE	C265
	CAP, ELECTROLYTIC 47UF, 10V	C266
	CAP, MYLAR 0.0047UF, 50WV +/-5% MINI SIZE	C267
	CAP, MYLAR 0.022UF, 50WV +/-5% MINI SIZE	C268
	CAP, MYLAR 0.0018UF, 50WV +/-5% MINI SIZE	C269
	CAP, CHIP 220PF	C270
	CAP, TANTALUM 4.7UF, 16WV	C271
	CAP, TANTALUM 4.7UF, 16WV	C272
	TANTALUM DIP 0.1UF, 16WV	C274
	CAP, CERAMIC AXIAL 0.001UF	C275

PART NO.	DESCRIPTION	SYMBOL
	CAP, CERAMIC AXIAL 0.01UF	C276
	CAP, ELECTROLYTIC 47UF, 10V	C277
	CERAMIC MONOLITHIC	C278
	CAP, TANTALUM 10UF, 16WV	C279
	CAP, CERAMIC AXIAL 0.001UF	C280
	CAP, CERAMIC 5.6PF	C281
	CAP, CERAMIC 47PF	C282
	CAP, CERAMIC 22PF	C283
	CAP, CERAMIC CHIP 0.001UF	C284
	CAP, CHIP 0.001UF	C285
	CAP, CERAMIC CHIP 0.001UF	C286
	CAP, CERAMIC CHIP 0.001UF	C287
	CAP, CERAMIC CHIP 0.001UF	C289
	CAP, CERAMIC MONOLITHIC	C290
	CAP, TANTALUM 1.0UF 16WV	C291
	CAP, CERAMIC CHIP 0.001UF	C292
	CAP, CHIP 220PF	C293
	CAP, TANTALUM 1.0UF 16WV	C294
	CAP, TANTALUM 1.0UF 16WV	C295
	CAP, CERAMIC CHIP 0.001UF	C296
	CAP, TANTALUM 10UF 16WV	C297
	CAP, ELECTROLYTIC 47UF 16 V	C298
	CAP, CERAMIC CHIP 0.001UF	C299
	CAP, CHIP 220PF	C300
	CAP, CERAMIC CHIP 12PF	C301
	CAP, MONOLITHIC 5PF	C302
	CAP, CERAMIC MONOLITHIC 4PF	C303
	CAP, CERAMIC CHIP 0.001UF	C304
	CAP, ELECTROLYTIC 47UF 16V	C305
	CAP, CERAMIC CHIP 0.001UF	C306
	CAP, TANTALUM 10UF 16WV	C307
	CAP, CERAMIC CHIP 0.001UF	C308
	CAP, CERAMIC CHIP 100PF	C309
	CAP, CHIP 220PF	C310
	CAP, CERAMIC CHIP 0.001UF	C311
	CAP, CERAMIC CHIP 10PF	C312
	CAP, CHIP 220PF	C313
	CAP, CERAMIC MONOLITHIC 8PF	C315
	CAP, CERAMIC CHIP 0.5PF	C316
	CAP, CERAMIC CHIP 0.001UF	C317
	CAP, CHIP 220PF	C318
	CAP, CERAMIC CHIP 0.001UF	C319
	CAP, CERAMIC NONOLITHIC	C320
	CAP, CERAMIC CHIP 1PF	C321
	CAP, CHIP 220PF	C322

PART NO.	DESCRIPTION	SYMBOL
	CAP, TANTALUM 10UF, 16WV	C323
	CAP, CERAMIC CHIP 0.001UF	C324
	CAP, CERAMIC MONOLITHIC 7PF	C325
	CAP, CHIP 220PF	C326
	CAP, MONOLITHIC 5PF	C327
	CAP, CERAMIC CHIP 0.001UF	C328
	CAP, CERAMIC CHIP 0.5PF	C329
	CAP, ELECTROLYTIC 47UF, 16V	C330
	CAP, CERAMIC CHIP 0.001UF	C331
	CAP, CERAMIC CHIP 220P	C332
	CERAMIC MONOLITHIC	C333
	CERAMIC AXIAL 220PF	C360
	CERAMIC AXIAL 220PF	C361
	CAP, CHIP 0.047UF	C401
	CAP, CHIP .047UF	C402
	CAP, CHIP 0.047UF	C403
	TANTALUM, CHIP 10YF	C404
	CAP, CHIP 0.047UF	C405
	CAP, CHIP 0.047UF	C406
	CAP, CHIP 0.047UF	C420
	CAP, CHIP 0.047UF	C421
	CAP, CHIP 0.047UF	C422
	CAP, CHIP 0.047UF	C423
	CAP, CERAMIC DISK 470PF, 50WV	C501
	FILTER, CERAMIC LT455EW	CF1
	CAP, FEED THROUGH 1000PF	CF2
	DIODE 1N4148 (AUDIO RELAY PCB)	D1
	DIODE 1N4148 (RF PCB)	D2
	DIODE 1N4148	D2
	DIODE 1SS133	D3
	DIODE 1SS133	D4
	DIODE 1SS133	D6
	DIODE GE 1N602	D7
	DIODE GE 1N602	D8
	DIODE SI 282-BA	D9
	DIODE SI 282-BA	D9
	DIODE SI 282-BA	D11
	DIODE 1N4148	D12
	DIODE 2A100V (RF PCB)	D13
	DIODE IN4003	D14
	DIODE SILICON SCHOTT1SS97	D15
	DIODE PIN UM9401	D16
	DIODE PIN UM9401	D17
	DIODE IN4003	D101
	DIODE IN4003	D102

PART NO.	DESCRIPTION	SYMBOL
	DIODE ZENER 1N5252B	D103
	DIODE 1N5819	D104
	DIODE ZENER 1N5227B	D105
	DIODE LED LAMP SLC22UR3	D109
	DIODE SILICON BB515	D110
	DIODE LED LAMP SLC22UR3	D111
	DIODE 1N4148	D111
	DIODE LED LAMP SLC22UR3	D112
	DIODE 1N4148	D116
	DIODE 1N4148	D117
	DIODE 1N4148	D118
	DIODE ZENER 1N5235B	D119
	DIODE 1N4148	D120
	DIODE 1N4148	D121
	DIODE SI BB609A	D122
	DIODE SILICON BB515	D123
	DIODE 1N4148	D124
	BEAD CORE 56 59065-4B	FB1
	BEAD CORE 56 59065-4B	FB2
	BEAD CORE 56 59065-4B	FB3
	BEAD CORE 56 59065-4B	FB4
	BEAD CORE 56 59065-4B	FB5
	BEAD CORE 56 59065-4B	FB6
	BEAD CORE 56 59065-4B	FB7
	BEAD CORE 56 59065-4B	FB8
	BEAD CORE 56 59065-4B	FB9
	FLUORESCENT DISPLAY 4-ST-01ZS1	FL1
R29/ 229-074-0	I.C. MB3756	IC1
R29/ 231-064-4	I.C. LM358M	IC4
R29/ 223-008-1	I.C. MC3357P	IC2
	I.C. KIA358P	IC5
	I.C. KIA358P	IC3
R29/ 229-383-9	I.C. UCN 5810A or AF	IC104
R29/ 229-075-1	I.C. TDA2003H	IC103
R29/ 229-104-4	I.C. MB504P	IC109
R29/ 229-463-8Z	I.C. AT93C56-10PC	IC108
R29/ 229-383-9	I.C. UCN 5810A or AF	IC105
R29/ 229-503-1	I.C. 80C51-ARC (SM-4000EX)	IC107
R29/ 229-516-3	I.C. MB501P DIP 08P MO1	IC117
R29/ 223-152-7	I.C. MC145048	IC119
	I.C. AN6540	IC102
	I.C. KIA4558P	IC114
R29/ 223-109-9	I.C. MC142100CP	IC109
	I.C. KA78L05	IC116
	I.C. KIA358P	IC111

PART NO.	DESCRIPTION	SYMBOL
R29/ 223-001-4Z	I.C. KIA7805PI	IC101
R29/ 223-080-5	I.C. MC14066B	IC115
R29/ 224-022-8	I.C. LA6458S	IC110
R29/ 224-022-8	I.C. LA6458S	IC112
R29/ 223-137-4	I.C. MC145156P2	IC118
R29/ 223-140-6	I.C. SN74LS257A	IC106
	I.C. KIA4558P	IC113
R29/ 231-064-4	I.C. LM358M	IC120
	SPRING COIL 3.0DIAX0.5DIAX1.5T(R)	L1
	SPRING COIL 3.0DIAX0.5DIAX1.5T(R)	L2
	COIL, AXIAL 1 MH	L3
	COIL, AXIAL 100UH	L4
	COIL, AXIAL .22UH	L5
	COIL, AXIAL 1 MH	L6
	COIL, AXIAL .22UH	L7
	COIL, AXIAL .82UH	L8
	COIL, AXIAL .22UH	L9
	COIL, AXIAL 1 MH	L10
	COIL, AXIAL .22UH	L11
	COIL, AXIAL 2.2UH	L12
	COIL, AXIAL .22UH	L13
	COIL, AXIAL .22UH	L14
	COIL, AXIAL 1 MH	L15
	COIL, AXIAL 1 MH	L16
	COIL, AXIAL 1 MH	L17
	COIL, AXIAL 1 MH	L18
	COIL, AXIAL 1 MH	L19
	COIL, AXIAL 1 MH	L20
	COIL, AXIAL .22UH	L21
	SPRING COIL 3.0DIAX0.5DIAX1.5T(L)	L22
	COIL, AXIAL .22UH	L23
	SPRING COIL 2.4&XO.L4&X6(1/2)R	L24
	SPRING COIL 2.4&XO.L4&X6(1/2)R	L25
	COIL, AXIAL 2.2UH	L26
	SPRING COIL 3.0DIAX0.7DIAX4.5T(L)	L27
	COIL, INDUCTOR MK-30 (100 OHM, 1/2W ON 8T)	L28
	COIL, INDUCTOR MK-30 (100 OHM, 1/2W ON 8T)	L29
	SPRING COIL 3.0DIAX0.65DIAX6T(R)	L30
	COIL, ASS'Y 0.6DIAX15T	L31
	TRANSFORMER CHOKE	L32
	COIL, INDUCTOR MK-30 (4T)	L33
	COIL, INDUCTOR MK-30 (4T)	L34
	COIL, AXIAL 1UH	L35
	COIL, AXIAL 1UH	L36
	COIL, AXIAL 2.2UH	L37

PART NO.	DESCRIPTION	SYMBOL
	COIL, AXIAL 100UH	L101
	COIL, AXIAL 100UH	L102
	COIL, AXIAL 1UH	L103
	COIL, AXIAL 1UH	L104
	COIL, AXIAL 1UH	L105
	COIL, AXIAL 2.2UH	L106
	COIL, AXIAL 1UH	L111
	COIL, AXIAL 1UH	L112
	SPRING COIL 2.8DIA X 0.5DIA X 3.5T(R)	L113
	COIL, AXIAL 0.22UH	L114
	TRANSISTOR MPS9681(T) (AUDIO RELAY PCB)	Q1
	TRANSISTOR MRF9511 (RF PCB)	Q1
	TRANSISTOR LSP966 (RF PCB)	Q2
	FET J310 (RF PCB)	Q2
	TRANSISTOR MPS9426(C)	Q3
	TRANSISTOR MPS9618(T)	Q4
	TRANSISTOR MPS9631(T)	Q5
	TRANSISTOR MPS9631(T)	Q6
	TRANSISTOR MPS9631(T)	Q7
	TRANSISTOR MPS9618(T)	Q8
	TRANSISTOR KTB1367	Q9
	TRANSISTOR LP1001	Q10
	TRANSISTOR MRF581	Q11
	TRANSISTOR MRF630	Q12
	TRANSISTOR MRF654	Q13
	TRANSISTOR MRF650	Q14
	TRANSISTOR MPS9681(T)	Q101
	TRANSISTOR MPS9631(T)	Q102
	TRANSISTOR MPS9618(T)	Q103
	TRANSISTOR KSP2222	Q104
	TRANSISTOR KSP2222	Q105
	TRANSISTOR MPS9681(T)	Q106
	TRANSISTOR MPS9681(T)	Q107
	TRANSISTOR MPS9631(T)	Q108
	TRANSISTOR MPS9631(T)	Q109
	TRANSISTOR MPS9631(T)	Q110
	TRANSISTOR BC848BT	Q111
	TRANSISTOR BC848BT	Q112
	TRANSISTOR BC848BT	Q113
	TRANSISTOR BC858BL	Q114
	TRANSISTOR MRF5711	Q115
	TRANSISTOR BC848BT	Q116
	TRANSISTOR BFR92A REEL	Q117
	FET BF998-E6327	Q118
	TRANSISTOR BFR92A REEL	Q119

PART NO.	DESCRIPTION	SYMBOL
	RES, METAL 100 OHM 1/8W +/-5% (RF PCB)	R1
	RES, METAL 470K OHM 1/8W +/-5% "S"+C433	R1
	RES, METAL 100 OHM 1/8W +/-5%	R3
	RES, METAL 6.2K OHM 1/8 +/-5% "S"	R4
	RES, METAL 2.7K OHM 1/8W +/-5% "S"	R5
	RES, METAL 100 OHM 1/8W +/-5%	R6
	RES, METAL 1.5K OHM 1/8 W +/-5% "S"	R7
	RES, METAL 8.2K OHM 1/8W +/-5% "S"	R8
	RES, METAL 2.2K OHM 1/8W +/-5% "S"	R9
	RES, METAL 3.3K OHM 1/8W +/-5% "S"	R10
	RES, METAL 820 OHM 1/8 +/-5% "S"	R11
	RES, METAL 68K OHM 1/8W +/-5% "S"	R12
	RES, METAL 22K OHM 1/8W +/-5% "S"	R13
	RES, METAL 560 OHM 1/8W +/-5% "S"	R14
	RES, METAL 47K OHM 1/8W +/-5% "S"	R15
	RES, METAL 2.7K OHM 1/8W +/-5% "S"	R16
	RES, METAL 2.7K OHM 1/8W +/-5% "S"	R17
	RES, METAL 5.1K OHM 1/8W +/-5% "S"	R18
	RES, METAL 270 OHM 1/8W +/-5% "S"	R19
	RES, METAL 10K OHM 1/8W +/-5% "S"	R20
	RES, METAL 2.2K OHM 1/8W +/-5% "S"	R21
	RES, METAL 47K OHM 1/8W +/-5% "S"	R22
	RES, METAL 270 OHM 1/8W +/-5% "S"	R23
	RES, METAL 2.2K OHM 1/8W +/-5% "S"	R24
	RES, METAL 10K OHM 1/8W +/-5% "S"	R25
	RES, METAL 4.7K OHM 1/8W +/-5% "S"	R26
	RES, METAL 1.2K OHM 1/8W +/-5% "S"	R27
	RES, METAL 390 OHM 1/8W +/-5% "S"	R28
	RES, METAL 330 OHM 1/8 +/-5% "S"	R29
	RES, METAL 470 OHM 1/8 +/-5% "S"	R30
	RES, METAL 1.5K OHM 1/8 W +/-5% "S"	R31
	RES, METAL 1.5K OHM 1/8 W +/-5% "S"	R32
	RES, METAL 47K OHM 1/8W +/-5% "S"	R33
	RES, METAL 33K OHM 1/8 W +/-5% "S"	R34
	RES, METAL 100 OHM 1/8W +/-5%	R35
	RES, METAL 1K OHM 1/8W +/-5% "S"	R36
	RES, METAL 3.3K OHM 1/8W +/-5% "S"	R37
	RES, METAL 33K OHM 1/8 W +/-5% "S"	R38
	RES, METAL 39K OHM 1/8W +/-5% "S"	R39
	RES, METAL 4.43K OHM 1/8W +/-1% "S"	R40
	RES, METAL 2.42K OHM 1/8W +/-1% "S"	R41
	RES, METAL 2K OHM 1/8W +/-5% "S"	R42
	RES, METAL 33K OHM 1/8 W +/-5% "S"	R42
	RES, METAL 21.3K OHM 1/8W +/-1% "S"	R43
	RES, 8.2K 1/8W +/-5%	R43A

PART NO.	DESCRIPTION	SYMBOL
	RES, METAL 10K OHM 1/8W +/-5% "S"	R44
	RES, METAL 1K OHM 1/8W +/-5% "S"	R45
	RES, METAL 220 OHM 1/8W +/-5% "S"	R46
	RES, METAL 8.2K OHM 1/8W +/-5% "S"	R47
	RES, METAL 3.3K OHM 1/8W +/-5% "S"	R48
	RES, METAL 1M OHM 1/8W +/-5% "S"	R49
	RES, METAL 1.2K OHM 1/8W +/-5% "S"	R50
	RES, METAL 150 OHM 1/8W +/-5% "S" MINI	R51
	RES, METAL 330 OHM 1/2W +/-5% "S"	R52
	RES, METAL 1.8K OHM 1/2W +/-5% "S"	R53
	RES, METAL 100 OHM 1/8W +/-5%	R56
	RES, CHIP 100 OHM 1/10W +/-5%	R57
	RES, METAL 1K OHM 1/8W +/-5% "S"	R58
	RES, METAL 4.7 OHM 1/8W +/-5% "S"	R59
	RES, METAL 1K OHM 1/8W +/-5% "S"	R60
	RES, METAL 3.3 OHM 1/8W +/-5% "S"	R61
	RES, METAL 10 OHM 1/8W +/-5% "S"	R62
	RES, METAL 3.3K OHM 1/8W +/-5% "S"	R63
	RES, METAL 560 OHM 1/8W +/-5% "S"	R64
	RES, METAL 820 OHM 1/8 +/-5% "S"	R65
	RES, METAL 27 OHM 1/8W +/-5% "S"	R66
	RES, METALOXIDE 33 OHM 1W +/-5%	R67
	RES, METAL 2.2 OHM 1/8W +/-5% "S"	R68
	RES, METAL 100 OHM 1/2W +/-5% S MINI	R69
	RES, METAL 100 OHM 1/2W +/-5% S MINI	R70
	RES, METAL 10K OHM 1/8W +/-5% "S"	R71
	RES, METAL 1K OHM 1/8W +/-5% "S"	R71
	RES, METAL 560 OHM 1/8W +/-5% "S"	R201
	RES, METAL 22K OHM 1/8W +/-5% "S"	R202
	RES, METAL 10K OHM 1/8W +/-5% "S"	R203
	RES, METAL 120 OHM 1/8W +/-5% "S"	R204
	RES, METAL 100 OHM 1/8W +/-5%	R205
	RES, METAL 330 OHM 1/8 +/-5% "S"	R206
	RES, METAL 47K OHM 1/8W +/-5% "S"	R207
	RES, METAL 15K OHM 1/8W +/-5% "S"	R208
	RES, METAL 68 OHM 1/8W +/-5% "S"	R209
	RES, METAL 22K OHM 1/8W +/-5% "S"	R210
	RES, METAL 8.2K OHM 1/8W +/-5% "S"	R211
	RES, METAL 10K OHM 1/8W +/-5% "S"	R212
	RES, METAL 220 OHM 1/8W +/-5% "S"	R213
	RES, METAL 220 OHM 1/8W +/-5% "S"	R214
	RES, METAL 47K OHM 1/8W +/-5% "S"	R215
	RES, METAL 10K OHM 1/8W +/-5% "S"	R216
	RES, METAL 10K OHM 1/8W +/-5% "S"	R217
	RES, METAL 10K OHM 1/8W +/-5% "S"	R218

PART NO.	DESCRIPTION	SYMBOL
	RES, METAL 100K OHM 1/8W +/-5% "S"	R219
	RES, METAL 10K OHM 1/8W +/-5% "S"	R220
	RES, METAL 10K OHM 1/8W +/-5% "S"	R221
	RES, METAL 47K OHM 1/8W +/-5% "S"	R222
	RES, METAL 8.2K OHM 1/8W +/-5% "S"	R223
	RES, CARBONFILM 2.2K OHM 1/5W +/-5%	R224
	RES, METAL 3.3 OHM 1/8W +/-5% "S"	R225
	RES, METAL 3.3 OHM 1/8W +/-5% "S"	R226
	RES, METAL 3.3 OHM 1/8W +/-5% "S"	R227
	RES, METAL 3.3 OHM 1/8W +/-5% "S"	R228
	RES, METAL 3.3 OHM 1/8W +/-5% "S"	R229
	RES, METAL 3.3 OHM 1/8W +/-5% "S"	R230
	RES, METAL 3.3 OHM 1/8W +/-5% "S"	R231
	RES, METAL 3.3 OHM 1/8W +/-5% "S"	R232
	RES, 10K 1/8W +/-5%	R233
	RES, METAL 10K OHM 1/8W +/-5% "S"	R234
	RES, METAL 10K OHM 1/8W +/-5% "S"	R235
	RES, METAL 10K OHM 1/8W +/-5% "S"	R236
	RES, METAL 10K OHM 1/8W +/-5% "S"	R237
	RES, METAL 10K OHM 1/8W +/-5% "S"	R238
	RES, METAL 2.2K OHM 1/8W +/-5% "S"	R239
	RES, METAL 2.2K OHM 1/8W +/-5% "S"	R240
	RES, METAL 2.2K OHM 1/8W +/-5% "S"	R241
	RES, METAL 24K OHM 1/5W +/-5% "S"	R242
	RES, METAL 18K OHM 1/5W +/-5% "S"	R243
	RES, METAL 56K OHM 1/5W +/-5% "S"	R244
	RES, METAL 10K OHM 1/8W +/-5% "S"	R245
	RES, METAL 100K OHM 1/8W +/-5% "S"	R246
	RES, METAL 100K OHM 1/8W +/-5% "S"	R247
	RES, METAL 100K OHM 1/8W +/-5% "S"	R248
	RES, METAL 100K OHM 1/8W +/-5% "S"	R249
	RES, METAL 100K OHM 1/8W +/-5% "S"	R250
	RES, METAL 100K OHM 1/8W +/-5% "S"	R251
	RES, METAL 10K OHM 1/8W +/-5% "S"	R254
	RES, METAL 220K OHM 1/8W +/-5% "S"	R255
	RES, METAL 3.3K OHM 1/8W +/-5% "S"	R256
	RES, METAL 4.7K OHM 1/8W +/-5% "S"	R257
	RES, METAL 5.6K OHM 1/8 +/-5% "S"	R258
	RES, METAL 47K OHM 1/8W +/-5% "S"	R259
	RES, METAL 4.7K OHM 1/8W +/-5% "S"	R260
	RES, METAL 1K OHM 1/8W +/-5% "S"	R262
	RES, METAL 4.7K OHM 1/8W +/-5% "S"	R263
	RES, METAL 4.7K OHM 1/8W +/-5% "S"	R264
	RES, METAL 4.7K OHM 1/8W +/-5% "S"	R265
	RES, METAL 4.7K OHM 1/8W +/-5% "S"	R266

PART NO.	DESCRIPTION	SYMBOL
	RES, METAL 4.7K OHM 1/8W +/-5% "S"	R267
	RES, METAL 4.7K OHM 1/8W +/-5% "S"	R268
	RES, METAL 4.7K OHM 1/8W +/-5% "S"	R269
	RES, METAL 4.7K OHM 1/8W +/-5% "S"	R270
	RES, METAL 1 OHM 1/8 W +/-5% "S"	R271
	RES, METAL 1K OHM 1/8W +/-5% "S"	R272
	RES, METAL 10K OHM 1/8W +/-5% "S"	R273
	RES, METAL 680K OHM 1/8W +/-5% "S"	R275
	RES, METAL 680K OHM 1/8W +/-5% "S"	R276
	RES, METAL 10K OHM 1/8W +/-5% "S"	R277
	RES, METAL 680K OHM 1/8W +/-5% "S"	R278
	RES, METAL 220K OHM 1/8W +/-5% "S"	R279
	RES, METAL 150K OHM 1/8W +/-5% "S"	R280
	RES, METAL 82K OHM 1/8W +/-5% "S"	R281
	RES, METAL 5.6K OHM 1/8 +/-5% "S"	R282
	RES, METAL 3.3K OHM 1/8W +/-5% "S"	R283
	RES, METAL 620K OHM 1/8 W +/-5% "S"	R284
	RES, METAL 22K OHM 1/8W +/-5% "S"	R285
	RES, METAL 220K OHM 1/8 W +/-5% "S"	R286
	RES, METAL 1.5K OHM 1/8 W +/-5% "S"	R287
	RES, METAL 27K OHM 1/8 W +/-5% "S"	R288
	RES, METAL 33K OHM 1/8 W +/-5% "S"	R289
	RES, METAL 1.5K OHM 1/8 W +/-5% "S"	R290
	RES, METAL 270K OHM 1/8 W +/-5% "S"	R291
	RES, METAL 1.5K OHM 1/8 W +/-5% "S"	R292
	RES, METAL 10K OHM 1/8W +/-5% "S"	R293
	RES, METAL 10K OHM 1/8W +/-5% "S"	R294
	RES, METAL 4.7K OHM 1/8W +/-5% "S"	R295
	RES, METAL 10K OHM 1/8W +/-5% "S"	R296
	RES, METAL 10K OHM 1/8W +/-5% "S"	R297
	RES, METAL 47K OHM 1/8W +/-5% "S"	R298
	RES, METAL 5.6K OHM 1/8 +/-5% "S"	R299
	RES, METAL 10K OHM 1/8W +/-5% "S"	R300
	RES, METAL 10K OHM 1/8W +/-5% "S"	R301
	RES, CHIP 47K OHM 1/10W +/-5%	R303
	RES, CHIP 33K OHM 1/10W +/- 5%	R304
	RES, CHIP 56K OHM 1/10 +/-5%	R306
	RES, METAL 47 OHM 1/4W +/-5% "S"	R307
	RES, METAL 12K OHM 1/8W +/-5% "S"	R308
	RES, METAL 3.3K OHM 1/8W +/-5% "S"	R309
	RES, METAL 1K OHM 1/8W +/-5% "S"	R310
	RES, METAL 68K OHM 1/8W +/-5% "S"	R311
	RES, METAL 180K OHM 1/8W +/-5% "S"	R312
	RES, CHIP 2.2K OHM 1/10W +/-5%	R313
	RES, CHIP 3.9K OHM 1/10W +/-5%	R314

PART NO.	DESCRIPTION	SYMBOL
	RES, CHIP 6.8K OHM 1/10W +/-5%	R315
	RES, CHIP 2.7K OHM 1/10W +/-5%	R316
	RES, CHIP 15K OHM 1/10W +/-5%	R317
	RES, CHIP 10 OHM 1/10W +/-5%	R318
	RES, METAL 1K OHM 1/8W +/-5% "S"	R319
	RES, CHIP 4.7K OHM 1/10W +/- 5%	R320
	RES, CHIP 1.2K OHM 1/10W +/-5%	R321
	RES, CHIP 1.2K OHM 1/10W +/-5%	R322
	RES, CHIP 10 OHM 1/10W +/-5%	R323
	RES, METAL 47K OHM 1/8W +/-5% "S"	R324
	RES, CHIP 5.6K OHM 1/10W +/-5%	R325
	RES, CHIP 1.8K OHM 1/10W +/-5%	R326
	RES, CHIP 220 OHM 1/10W +/-5%	R327
	RES, CHIP 2.2K OHM 1/10W +/-5%	R328
	RES, CHIP 47 OHM 1/10W +/-5%	R329
	RES, CHIP 10 OHM 1/10W +/-5%	R330
	RES, METAL 8.2K OHM 1/10W +/-5%	R331
	RES, CHIP 5.6K OHM 1/10W +/-5%	R332
	RES, CHIP 220 OHM 1/10W +/-5%	R333
	RES, CHIP 100K OHM 1/10W +/- 5%	R334
	RES, CHIP 82K OHM 1/10W +/-5%	R335
	RES, CHIP 22K OHM 1/10W +/-5%	R336
	RES, METAL 8.2K OHM 1/10W +/-5%	R337
	RES, CHIP 5.6K OHM 1/10W +/-5%	R338
	RES, CHIP 180 OHM 1/10W +/-5%	R339
	RES, CHIP 3.9K OHM 1/10W +/-5%	R340
	RES, CHIP 0 OHM 1/10W +/-5%	R341
	RES, CHIP 1K OHM 1/10W +/-5%	R343
	RES, METAL 470K OHM 1/8W +/-5%" "S"	R344
	RES, CHIP 100K OHM	R350
	RES, METAL 100K OHM 1/8W +/-5% "S"	R352
	RES, 5.6 OHM 1/8W +/-5%	R360
	RES, METAL 390K OHM 1/8 W +/-5% "S"	R374
	RES, CHIP 56K OHM 1/10W +/- 5%	R401
	RES, CHIP 10K OHM 1/10W +/- 5%	R402
	RES, CHIP 33K OHM 1/10W +/- 5%	R403
	RES, CHIP 4.7K OHM 1/10W +/- 5%	R404
	RES, CHIP 3.3K OHM 1/10W +/- 5%	R406
	RES, CHIP 270K OHM 1/10W +/-5%	R407
	RES, CHIP 1.2K OHM 1/10W +/-5%	R420
	RES, CHIP 120 OHM 1/10W +/-5%	R421
	RES, CHIP 68K OHM 1/10W +/- 5%	R422
	RES, CHIP 12K OHM 1/10W +/-5%	R423
	RES, CHIP 470 OHM 1/10W +/-5%	R424
	RES, CHIP 33 OHM 1/10W +/-5%	R425

PART NO.	DESCRIPTION	SYMBOL
	RES, CHIP 270K OHM 1/10W +/- 5%	R426
	RES, CHIP 560 OHM 1/10W +/- 5%	R427
	RES, 10K OHM	R814
	RES, 6.8K OHM	R815
R29/ 069-023-4	RES, ARRAY MHR-8-103JA 10K X 8, 9 PIN	RA1
R29/ 069-023-4	RES, ARRAY MHR-8-103JA 10K X 8, 9 PIN	RA2
R29/ 069-023-4	RES, ARRAY MHR-8-103JA 10K X 8, 9 PIN	RA3
	RES, SEMIFIXED 10K OHM	RV1
	RES, SEMIFIXED 10K OHM	RV2
	RES, SEMIFIXED 10K	RV3
	RES, SEMIFIXED 47K OHM	RV4
	RES, SEMIFIXED 22K OHM	RV5
R29/ 420-648-6	RELAY OUC-SS-105D 5V (AUDIO RELAY PCB)	RY1
	RES SEMIFIXED 2.2KB	RV401
R29/ 436-012-4	SW TACT SKHQFA (RED)	SW7
	FILTER HELICAL 460MHZ	T1
	FILTER HELICAL 460MHZ	T2
	FILTER HELICAL 460MHZ	T3
	FILTER HELICAL 440MHZ	T6
	COIL, IFT 21.4 MHZ (A)	T8
	COIL, IFT 21.4 MHZ (B)	T9
	COIL 455 KHZ DET	T10
R29/ 310-677-8	TRANSFORMER DC/DC CONVERTER	T101
R29/ 171-014-0	CAP, TRIMMER TZ03Z100ER 169	TC11
R29/ 171-014-0	CAP, TRIMMER TZ03Z100ER 169	TC12
R29/ 171-013-9	CAP, TRIMMER 10P (N) ECV-17W10X53T	TC13
R29/ 171-013-9	CAP, TRIMMER 10PF: ECV-17W10X53T	TC14
R29/ 098-252-8	THERMISTOR, 2.5K OHM +/-15%:KTD5-225 (DIG PCB)	TH1
R29/ 097-503-0	THERMISTOR, 50K OHM +/-15%:YTD5-350 (RF PCB)	TH1
R29/ 098-101-5	THERMISTOR, 100K OHM +/-15%:KTD5-110 (RF PCB)	TH2
R29/ 097-102-1	THERMISTOR, 1K OHM +/-15%:KTD5-210 (DIG PCB)	TH2
R29/ 099-303-6	THERMISTOR, 30K OHM +/-15%:KTD5-330	TH3
R29/ 450-104-0	RES, VARIABLE 171PN2-4 C10K12KC	VR1
R29/ 450-105-1	RES, VARIABLE 171PN2-4 A10K12KC	VR2
	CRYSTAL HC-184 8.2944 MHZ (DIG PCB)	X1
	X-TAL NR-18 20.945MHZ	X1
	CRYSTAL, UNIT NC-18C12.800MHZ (261-394-2Z)	X2

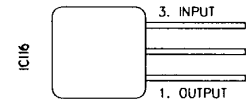
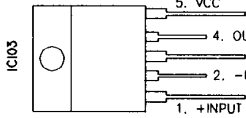
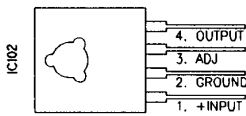
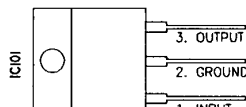
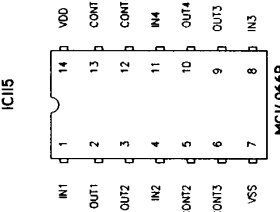
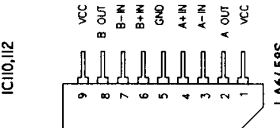
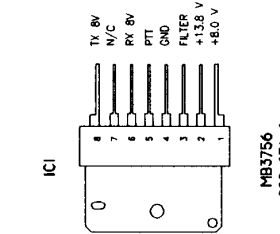
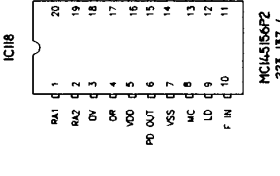
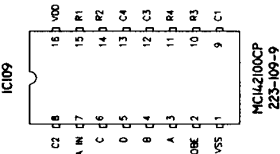
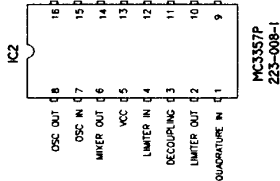
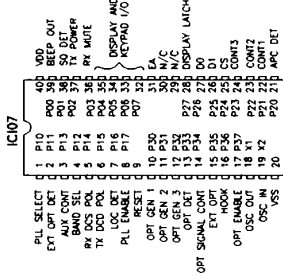
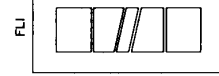
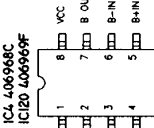
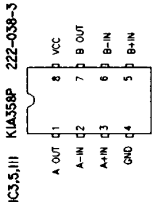
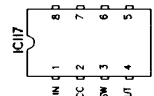
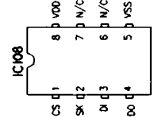
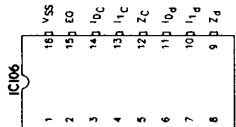
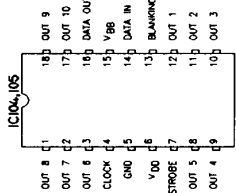

PRINTED CIRCUIT BOARD LAYOUT

MONOGRAM SERIES LBI-38865

TOP VIEW 406136-E RF BOARD

TOP VIEW 406136-E RF BOARD

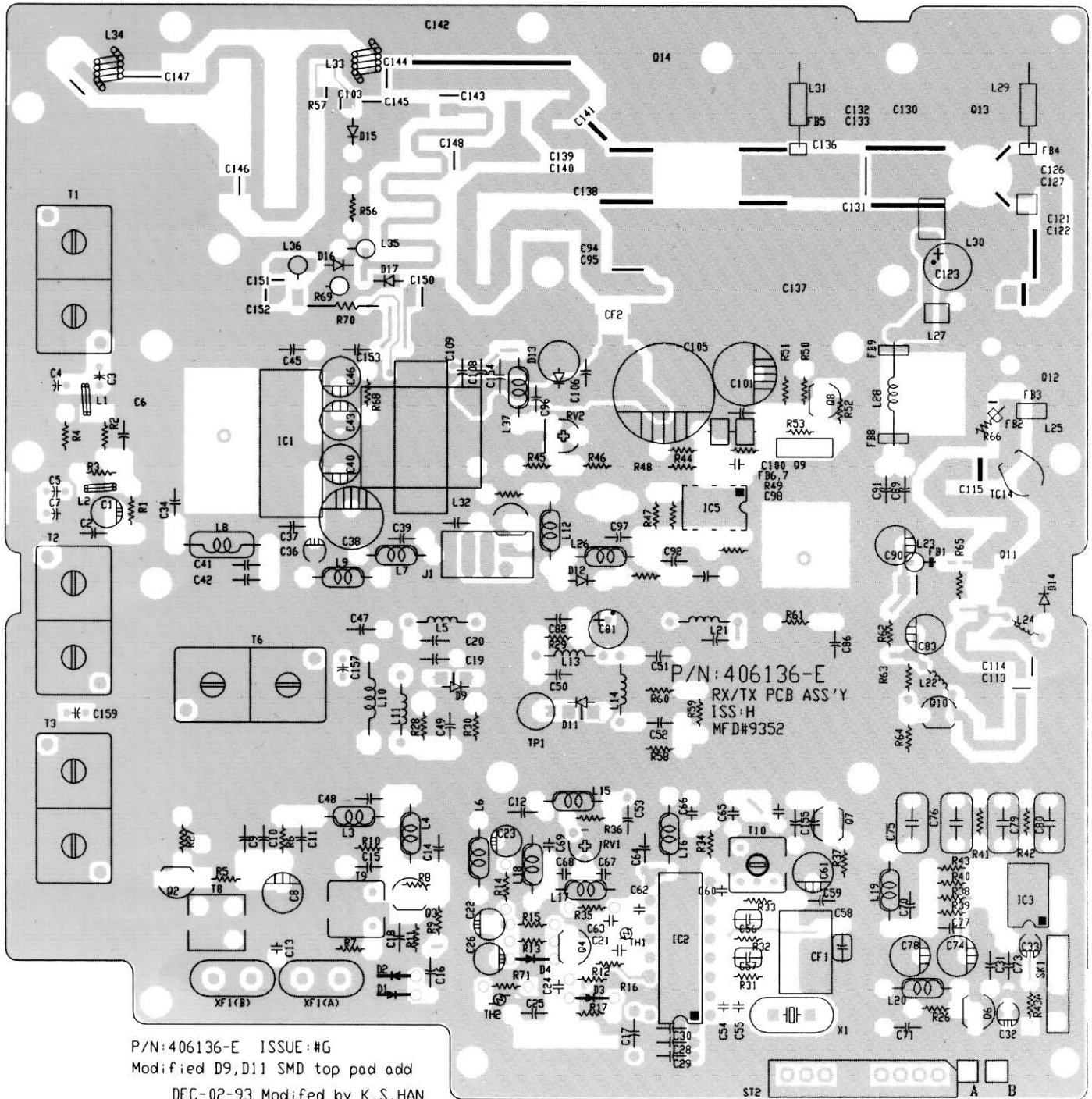

P/N:406136-E ISSUE:#G
Modified D9,D11 SMD top pad add
DEC-02-93 Modified by K.S,HAN

MONOGRAM SERIES LBI-38865

BOTTOM VIEW 406136-E RF BOARD

BOTTOM VIEW 406136-E RF BOARD

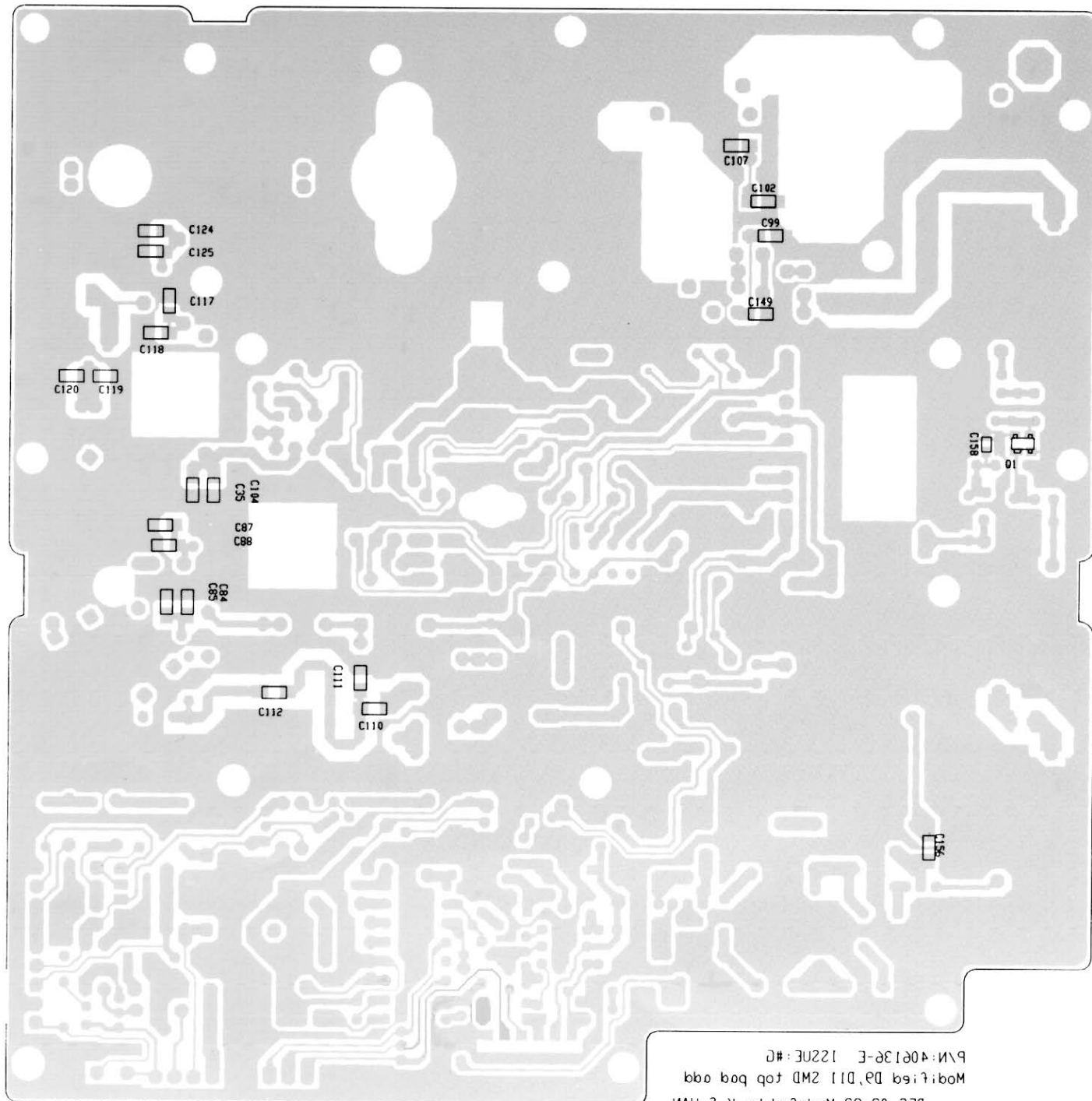

MONOGRAM SERIES LBI-38865

TOP VIEW 406137-E DIGITAL BOARD

TOP VIEW 406137-E DIGITAL BOARD

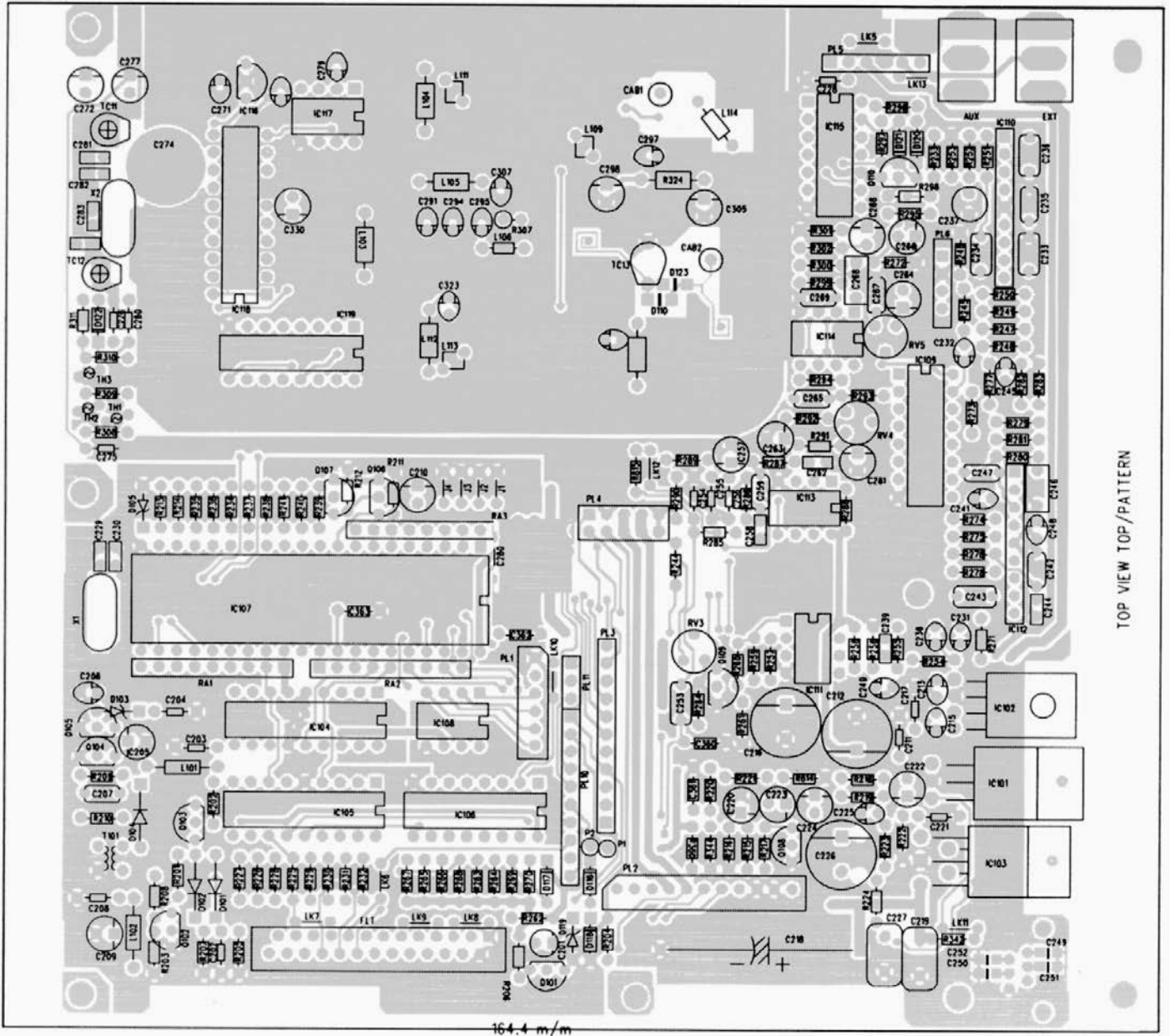

MONOGRAM SERIES LBI-38865
BOTTOM VIEW 406137-E DIGITAL BOARD

BOTTOM VIEW 406137-E DIGITAL BOARD

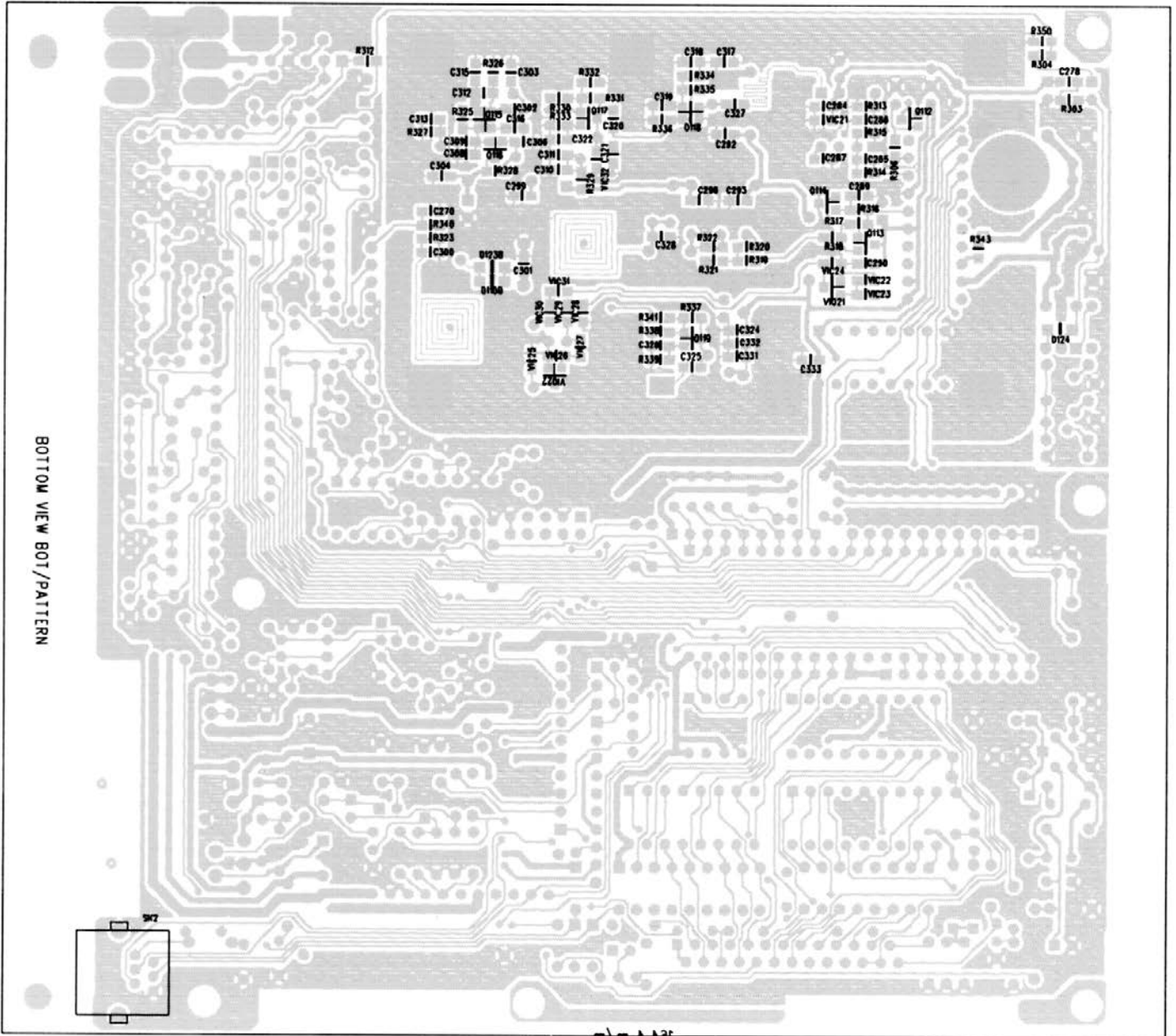

MONOGRAM SERIES LBI-38865
MISC. PRINTED CIRCUIT BOARDS

MISC. PRINTED CIRCUIT BOARDS

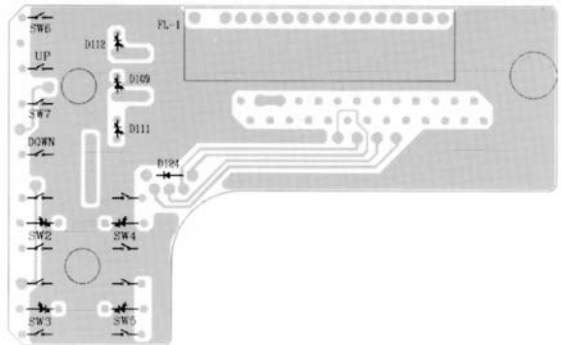

DISPLAY BOARD TOP VIEW

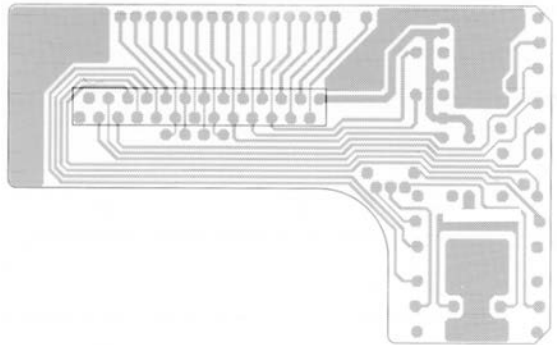

DISPLAY BOARD BOTTOM VIEW

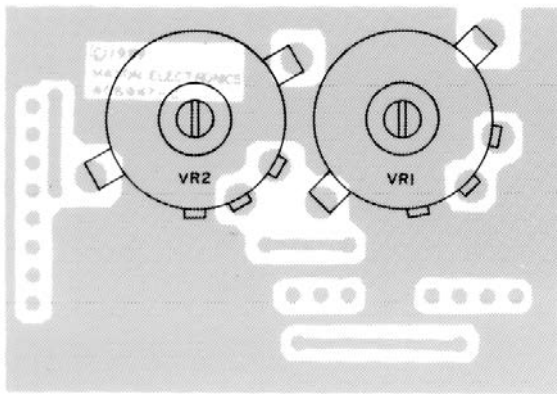

VOLUME BOARD TOP VIEW

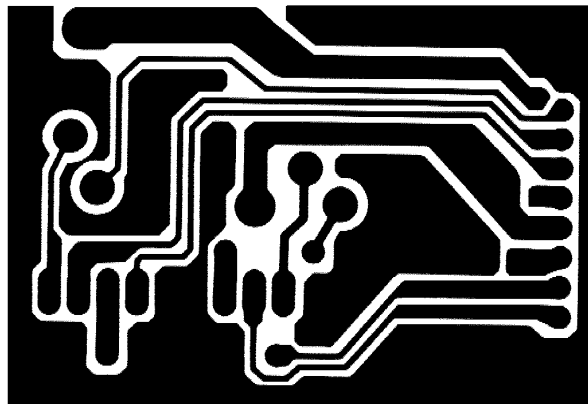

VOLUME BOARD BOTTOM VIEW

MONOGRAM SERIES LBI-38865
MISC. PRINTED CIRCUIT BOARDS

MISC. PRINTED CIRCUIT BOARDS

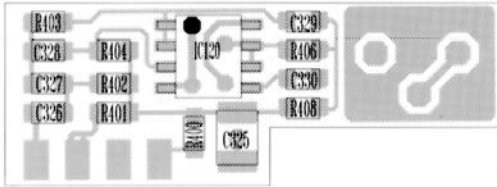

406-969-F (DIG. PCB) TOP

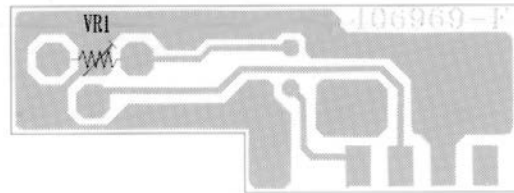

406-969-F (DIG. PCB) BOTTOM

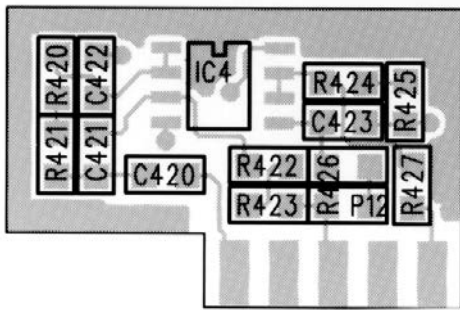

406-968-C (RF. PCB) TOP

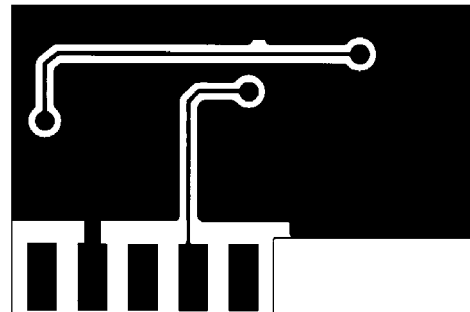

406-968-C (RF. PCB) BOTTOM

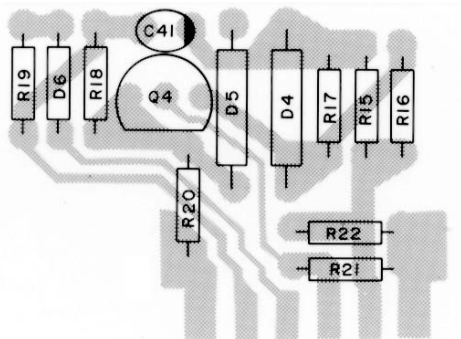

406-973-A TOP

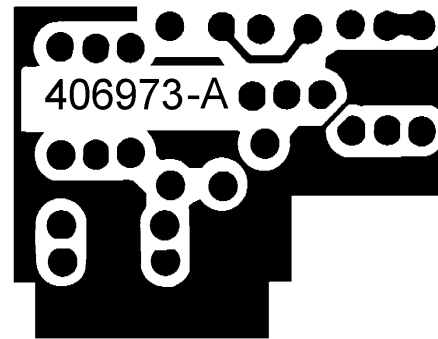

406-973-A BOTTOM

MONOGRAM SERIES LBI-38865

VOLTAGE CHARTS

VOLTAGE CHARTS

RF PCB

Q1	RX	TX
B	0.73	0.0
C	7.64	0.0
E	0.0	0.0

Q2	RX	TX
Gate	0.0	0.0
Source	2.19	0.0
Drain	7.93	0.0

Q3	RX	TX
B	2.3	0.0
E	1.59	0.0
C	3.95	0.0

Q4	RX	TX
C	7.32	7.32
E	6.82	6.65
B	2.87	4.18

Q7	RX	TX
C	8.3	8.3
B	4.0	0.0
E	3.35	0.0

Q6	RX		
	UNSQ	SQ	TX
E	0.0	0.0	0.0
B	0.05	0.69	0.72
C	0.96	0.0	0.0

Q8	RX	TX
E	0.0	2.8
B	0.0	3.4
C	13.8	11.0

Q9	RX	TX
E	13.8	12.8
C	3.3	9.5
B	13.8	13.5

Q10	RX	TX
B	0.0	0.32
E	0.0	0.0
C	0.15	6.9

Q11	RX	TX
E	0.0	0.0
B	0.13	0.67
C	0.13	7.26

Q12	RX	TX
C	3.4	9.5
B	0.0	0.0
E	0.0	0.0

Q13	RX	TX
E	0.0	0.0
B	0.0	0.0
C	3.3	9.6

Q14	RX	TX
E	0.0	0.0
B	0.0	0.0
C	13.8	13.4

IC1	RX	TX
1	8.3	8.3
2	13.8	13.5
3	8.3	8.3
4	0.0	0.0
5	4.25	0.0
6	8.3	0.0
7	0.0	0.0
8	0.15	8.3

IC2	RX		
	UNSQ	SQ	TX
1	8.0	8.0	0.0
2	7.45	7.45	0.0
3	7.9	0.0	0.0
4	8.1	8.1	0.0
5	1.0	1.0	0.0
6	1.0	1.0	0.0
7	1.0	1.0	0.0
8	7.9	7.9	0.0
9	4.0	4.0	0.0
10	1.9	1.9	0.5
11	1.9	1.9	1.0
12	0.0	1.30	0.19
13	7.4	0.0	0.14
14	0.0	5.0	5.0
15	0.0	0.0	0.0
16	2.0	2.0	0.0

IC3	RX	TX
1	4.5	4.5
2	4.5	4.5
3	4.5	4.5
4	0.0	0.0
5	4.5	4.5
6	4.5	4.5
7	4.5	4.5
8	8.3	8.3

IC5	RX	TX
1	0.0	3.6
2	1.52	2.19
3	0.0	2.19
4	0.0	0.0
5	0.5	0.5
6	0.48	0.49
7	0.0	0.0
8	8.4	8.4

406968-F Sub PCB		
IC4	RX	TX
1	4.4	4.5
2	4.4	4.5
3	4.4	4.4
4	0.0	0.0
5	4.3	4.3
6	4.5	4.6
7	4.5	4.6
8	8.2	8.2

MONOGRAM SERIES LBI-38865

VOLTAGE CHARTS

VOLTAGE CHARTS

DIGITAL PCB

IC101	RX	TX
IN	13.8	13.4
GND	0.0	0.0
OUT	5.0	5.0

IC102	RX	TX
1	13.8	13.4
2	0.0	0.0
3	0.0	0.0
4	8.6	8.6

IC103	RX	TX
1	1.40	1.40
2	0.8	0.8
3	0.0	0.0
4	6.5	6.2
5	13.8	13.4

IC104	RX	TX
1	0.0	0.0
2	0.0	0.0
3	3.90	3.90
4	4.40	4.40
5	0.0	0.0
6	5.0	5.0
7	0.0	0.0
8	3.7	3.7
9	3.7	3.7
10	3.8	3.8
11	3.8	3.8
12	3.75	3.75
13	0.0	0.0
14	4.5	4.5
15	24.1	24.1
16	0.8	0.12
17	3.9	3.9
18	3.9	24.0

IC105	RX	TX
1	0.6	0.6
2	5.3	5.3
3	5.25	5.25
4	4.38	4.38
5	0.0	0.0
6	5.0	5.0
7	0.0	0.0
8	7.8	7.8
9	7.95	7.95
10	5.3	5.3
11	7.9	8.4
12	5.3	5.3
13	0.0	0.0
14	4.6	4.6
15	15.0	14.95
16	1.65	0.22
17	5.58	5.60
18	5.58	14.80

IC106	RX	TX
1	0.0	0.0
2	5.0	0.0
3	5.0	5.0
4	4.4	4.4
5	5.0	5.0
6	5.0	5.0
7	4.6	4.6
8	0.0	0.0
9	5.0	5.0
10	5.0	5.0
11	5.0	5.0
12	4.5	4.5
13	5.0	5.0
14	5.0	5.0
15	4.9	4.9
16	5.0	5.0

	RX		
	UNSQ	SQ	TX
1	5.0	5.0	5.0
2	5.0	5.0	5.0
3	5.0	5.0	5.0
4	5.0	5.0	5.0
5	5.0	5.0	5.0
6	0.0	0.0	0.0
7	0.0	0.0	0.0
8	0.0	0.0	0.0
9	0.0	0.0	0.0
10	0.1	0.1	0.1
11	0.1	0.1	0.1
12	0.1	0.1	0.1
13	5.0	5.0	5.0
14	0.0	0.0	0.0
15	0.0	0.0	0.0
16	0.0	0.0	0.0
17	5.0	5.0	0.0
18	2.5	2.5	2.5
19	2.3	2.3	2.3
20	0.0	0.0	0.0
21	5.0	5.0	5.0
22	0.0	0.0	0.0
23	5.0	5.0	5.0
24	0.0	0.0	0.0
25	0.0	0.0	0.0
26	0.0	0.0	0.0
27	5.0	5.0	5.0
28	0.0	0.0	0.0
29	5.0	5.0	5.0
30	1.60	1.60	1.60
31	5.0	5.0	5.0
32	5.0	5.0	5.0
33	4.6	4.6	4.6
34	4.5	4.5	4.5
35	4.4	4.4	4.4
36	0.0	2.4	2.4
37	0.0	4.24	0.0
38	0.0	5.0	5.0
39	2.5	2.5	2.5
40	5.0	5.0	5.0

MONOGRAM SERIES LBI-38865

VOLTAGE CHARTS

VOLTAGE CHARTS

IC108	RX	TX
1	0.0	0.0
2	0.0	0.0
3	0.0	0.0
4	5.0	5.0
5	0.0	0.0
6	5.0	5.0
7	0.0	0.0
8	5.0	5.0

IC111	RX	TX
1	0.0	0.0
2	1.90	1.90
3	1.70	1.70
4	0.0	0.0
5	1.90	1.90
6	1.90	1.90
7	1.90	1.90
8	5.0	5.0

IC115	RX	TX
1	1.8	1.8
2	0.0	0.0
3	0.0	0.0
4	2.8	2.8
5	0.0	0.0
6	0.0	5.0
7	0.0	0.0
8	0.0	2.7
9	4.5	2.8
10	0.0	0.0
11	0.0	2.8
12	4.2	0.0
13	0.5	0.6
14	5.0	5.0

IC118	RX	TX
1	8.6	8.6
2	8.6	8.6
3	8.6	8.6
4	8.6	8.6
5	8.6	8.6
6	3.2	6.9
7	0.0	0.0
8	7.9	8.4
9	8.5	8.5
10	4.1	4.1
11	0.0	0.0
12	0.0	0.0
13	0.0	0.0
14	0.0	0.0
15	0.0	0.0
16	0.0	0.0
17	4.8	4.8
18	4.2	4.2
19	4.1	4.1
20	8.6	8.6

IC109	RX	TX
1	0.0	0.0
2	0.0	0.0
3	0.11	0.13
4	0.11	0.13
5	0.11	0.13
6	5.0	5.0
7	0.0	0.0
8	0.0	0.0
9	1.5	0.0
10	2.0	1.95
11	1.8	1.9
12	0.0	0.0
13	3.0	3.0
14	1.8	1.8
15	3.0	3.0
16	5.0	5.0

IC112	RX	TX
1	5.0	5.0
2	1.8	1.9
3	1.8	1.8
4	1.8	1.8
5	0.0	0.0
6	1.6	1.6
7	2.0	2.0
8	2.0	2.0
9	5.0	5.0

IC116	RX	TX
OUT	5.0	5.0
GND	0.0	0.0
IN	8.6	8.6

IC113	RX	TX
1	2.8	2.8
2	2.8	2.8
3	2.8	2.8
4	0.0	0.0
5	2.8	2.8
6	2.8	2.8
7	2.8	2.8
8	5.0	5.0

IC117	RX	TX
1	2.4	2.4
2	5.0	5.0
3	0.0	0.0
4	2.7	2.7
5	0.0	0.0
6	4.6	4.9
7	0.0	0.0
8	2.5	2.5

IC119	RX	TX
1	5.0	5.0
2	8.6	8.6
3	0.0	0.0
4	8.6	8.6
5	0.0	0.0
6	0.0	0.0
7	0.0	0.0
8	0.0	0.0
9	0.0	0.0
10	0.0	0.0
11	0.0	0.0
12	0.0	0.0
13	5.0	5.0
14	0.0	0.0
15	0.0	0.0
16	8.6	8.6

IC110	RX	TX
1	5.0	5.0
2	2.5	2.5
3	2.5	2.5
4	2.5	2.5
5	0.0	0.0
6	2.5	2.5
7	0.0	0.0
8	2.5	2.5
9	5.0	5.0

IC114	RX	TX
1	4.5	2.8
2	4.5	2.8
3	0.1	2.8
4	0.0	0.0
5	2.8	2.8
6	2.8	2.8
7	2.8	2.8
8	5.0	5.0

MONOGRAM SERIES LBI-38865

VOLTAGE CHARTS

Q101	RX	TX
C	4.3	4.3
B	5.0	5.0
E	5.8	5.8

Q102	RX	TX
E	0.0	0.0
B	0.11	0.14
C	14.0	14.0

Q103	RX	TX
E	15.5	15.5
B	16.0	16.0
C	24.2	24.2

Q104	RX	TX
E	0.0	0.0
B	0.35	0.35
C	13.6	13.2

Q105	RX	TX
E	0.0	0.0
B	0.6	0.6
C	0.33	0.33

Q106	RX	TX
E	5.0	5.0
B	5.0	5.0
C	0.0	0.0

Q107	RX	TX
E	5.0	5.0
B	4.2	4.2
C	5.0	5.0

Q108	RX	TX
C	0.0	0.0
B	0.67	0.69
E	0.0	0.0

Q109	RX	TX
C	0.0	0.0
B	0.0	0.0
E	5.0	5.0

Q110	RX	TX
C	0.0	0.0
B	0.65	0.0
E	0.0	5.0

Q112	RX	TX
C	0.0	0.0
B	0.66	0.65
E	0.0	0.0

Q113	RX	TX
E	8.3	8.3
C	8.6	8.6
B	0.4	0.4

Q114	RX	TX
E	0.0	0.0
C	8.3	8.3
B	0.3	0.3

Q115	RX	TX
C	7.6	7.6
B	1.8	1.8
E	1.27	1.27

Q116	RX	TX
B	8.24	8.24
E	7.57	8.57
C	8.28	8.28

Q117	RX	TX
C	8.16	8.16
B	2.89	2.89
E	2.12	2.12

Q118	RX	TX
GATE1	4.38	4.38
GATE2	0.93	0.95
D	8.6	8.6
S	0.0	0.0

Q119	RX	TX
C	8.65	8.65
E	2.28	2.25
B	2.94	2.93

406969	Sub PCB	
IC102	RX	TX
1	1.85	1.89
2	1.85	1.87
3	1.85	1.85
4	0.0	0.0
5	1.86	1.86
6	1.86	1.86
7	1.86	1.86
8	5.0	5.0

EXPLODED VIEW AND EXPLODED VIEW PARTS LIST

NOTE

Only those items indicated by shading will be stocked by After Market Services. All other items are for reference only.

When ordering parts for your Monogram Series radio, precede all part numbers with the prefix "R29/"

MONOGRAM SERIES LBI-38865

EXPLODED VIEW PARTS LIST LBI-38865

REF. NO	EGE P/N	DESCRIPTION	PART NO
1	R29 - 801-272	E.S.C NORYL N190-7002 BLK SPRAY	
2	R29 - 813-854	LENS ACRYL BLUE	
3	R29 - 420-152-4	SPEAKER A1727C03	
3B	R29 - 905-510	FELT (SPEAKER)	
4	R29 - 623-034	(+)TAPPING SCREW(PH)3X8-1S ZN-PLAT	
		P.C.B DISPLAY 71.5X44X1.2T FR4 1/1	
6A	R29 - 436-013-5	LIGHTED SWITCHES (GREEN)	
6B	R29 - 436-012-4	LIGHTED SWITCHES (RED)	
7	R29 - 893-685	RUBBER SPONGE 38X9XT2 RUBBER STICKER BLK	
8	R29 - 252-039-3	FLUORESCENT DISPLAY 4-ST-01ZS1	
9	R29 - 825-155-A	KNOB (FUNCTION KEY S) ACRYL CLEAR GOLD	
10	R29 - 825-156-A	KNOB (FUNCTION KEY P) ACRYL CLEAR GOLD	
11	R29 - 825-157-A	KNOB (FUNCTION KEY 1) ACRYL CLEAR GOLD	
12	R29 - 825-158-A	KNOB (FUNCTION KEY 2) ACRYL CLEAR GOLD	
13	R29 - 825-159-A	KNOB (FUNCTION KEY) ACRYL CLEAR GOLD	
14	R29 - 622-201	(+)TAPPING SCREW (PH)2X6-1S ZN-PLAT	
15	R29 - 622-201	(+)TAPPING SCREW (PH)2X6-1S ZN-PLAT	
		P.C.B VOLUME 50X35X1.2T FR4 1/1	
17-A	R29 - 450-104-0	VR 171PN2-4 C10K12KC	
17-B	R29 - 450-105-1	VR 171PS2-4 A10K12KC	
18	R29 - 650-220	NUT HEXAGON BSBM M7 (P:0.75)	
19	R29 - 825-125-A	KNOB (SQUELCH) N190J-7002 RED	
20	R29 - 825-120-A	KNOB (VOLUME) N190J-7002 RED	
		FRAME ALDC12 BLK SANDTONE SPRAY	
		P.C B DIGITAL 164.4X147X1.2T FR4 1/1	
		CRYSTAL HC-18U 8.2944MHZ 703142	
		CRYSTAL 12.800MHz SI-1060-0510-32	
25	R29 - 420-728-5	JACK MINIATURE HSJ1785-01-030	
26	R29 - 650-348	NUT RING	
27	R29 - 660-314	WASHER(SQUARE) SPC 10X7X&3.2XT1 ZN-PLAT	
28	R29 - 613-040	(+)MACHINE SCREW(PH)3X6 ZN-PLAT 1	
		PANEL TOP ALDC12 IRIDITE FINISH	
30	R29 - 613-147	(+)MACHINE SCREW(PH)3X18 ZN-PLAT	
31	R29 - 613-068	(+)MACHINE SCREW(PH)3X8 ZN-PLAT	
32	R29 - 893-675	CUSHION SPO.BLK T2 STIC.	
33	R29 - 422-907-0	CONNECTOR ANT SO-239 "M" TYPE	
34	R29 - 613-755	(+)MACHINE SCREW(PH)3X7 NI-PLAT	
		P.C.B RF MAIN 164.4X147X1.6T FR4 1/1	
		SPONGE RUBBER SPO.T2 STIC.	
37	R29 - 406-973-A	P.C.B SQ SUB 19X25X1.2T FR4 1/1	
		CUSHION 10X20XT8 RUBB.SPO.STIC.	
		CUSHION 16X20XT4 RUBB.SPO.STIC.	
		PANEL BOTTOM ALDC12 IRIDITE FINISH	
41	R29 - 723-400-D	BRACKET (DC CORD)	
42	R29 - 750-233	CORD STOPPER SR-6W-1	
43	R29 - 613-314	(+)MACHINE SCREW(BH)3X8 BLK	
		(+)MACHINE SCREW(PH)3X24 ZN-PLAT 1	

MONOGRAM SERIES LBI-38865

EXPLODED VIEW PARTS LIST LBI-38865

REF. NO	EGE P/N	DESCRIPTION	PART NO
45	R29 - 613-192	(+)MACHINE SCREW(FH)3X6 BLK FELT 10X130XT0.5 FELT STIC. FCC LABEL MADE IN KOREA FCC LABEL MADE IN THAILAND POLY LABEL COVER FOR FCC LABEL	
48	R29 - 717-315-D	COVER BOTTOM EGI T1 BLK ST.SPRAY	
49	R29 - 717-320-D	COVER TOP EGI T1 BLK ST.SPRAY	
50	R29 - 894-185	CUSHION 16X20XT4 RUBB.SPO.STIC. BRACKET ALDC12 SANDTONE SPRAY	
52	R29 - 625-007	(+)TAPPING SCREW(TH)5X12-1S ZN-PLAT	
53	R29 - 661-605	WASHER(FLAT) M6 ZN-PLAT	
54	R29 - 662-606	WASHER(SPRING) M6 ZN-PLAT	
55	R29 - 600-051	SECURING SCREW M6X9(P:1) BLK	
56	R29 - 203-186-2	TRANSISTOR MRF650 SHIELD PLATE PBSP 2X7XT0.2	
58	R29 - 508-085-A	BRACKET (MICROPHONE) (+)MACHINE SCREW(BH)3X4 NI-PLAT	
60	R29 - 662-310	WASHER (SPRING) M3 NI-PLAT NOT USED	
62	R29 - 664-305	WASHER (LOCK"A"TYPE)M3 ZN-PLAT 1	
63	R29 - 662-305	WASHER (SPRING) M3 ZN-PLAT 2 P.C.B PLL B'D FILTER30X11X1.6T FR4 1/1 P.C.B RF B'D FILTER 23X15X1.6T FR4 1/1	
66	R29 - 504-367	PLUG ASSY W/CABLE TMP-P01X-A1 85M/M NOT USED	
68	R29 - 203-067-8	TRANSISTOR MRF-654	
69	R29 - 761-745	HEAT SINK	

MONOGRAM SERIES LBI-38865

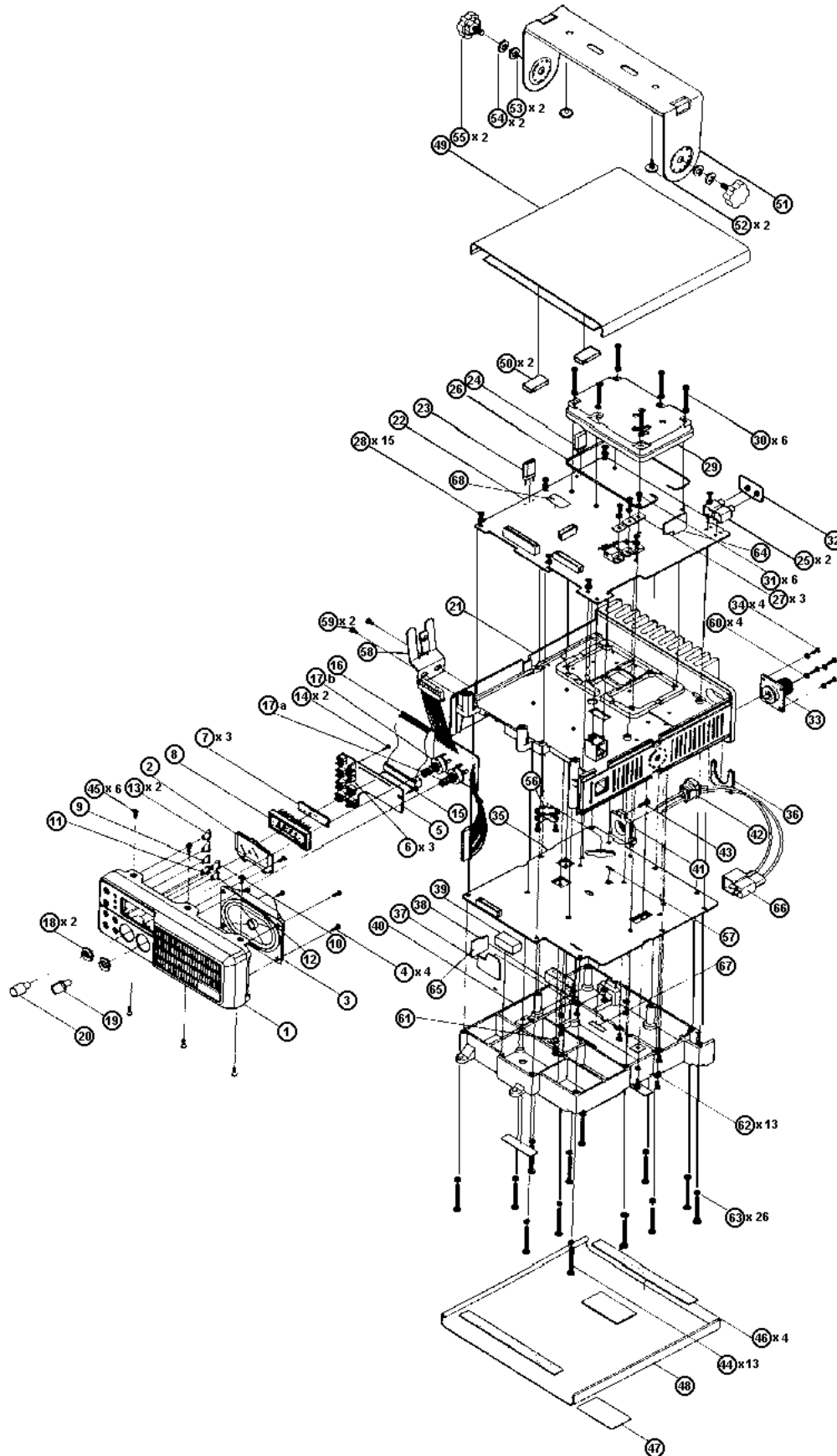

SCHEMATICS

Ericsson Inc.
Private Radio Systems
Mountain View Road
Lynchburg, Virginia 24502
1-800-528-7711 (Outside USA, 804-528-7711)

Printed in U.S.A.

