

# INSTRUCTIONS FOR AC OUTLET STRIP

## TABLE OF CONTENTS

	<u>Page</u>
DESCRIPTION .....	1
OUTLINE & SCHEMATIC DIAGRAM.....	2
INSTALLATION INSTRUCTIONS .....	3

## DESCRIPTION

The AC OUTLET STRIP 19B226209G1 contains three Dual AC outlets mounted in a slim metal housing with power cord. The outlet strip comes with necessary hardware to mount in a Desk Mate or Low Power Vertical Mount Cabinet as shown in the Installation Instructions 19D417519.

AC OUTLET STRIP 19B235073G1&G2 contains three DUAL AC outlets mounted in a slim metal housing with power cord for mounting horizontal in a station cabinet or open rack.

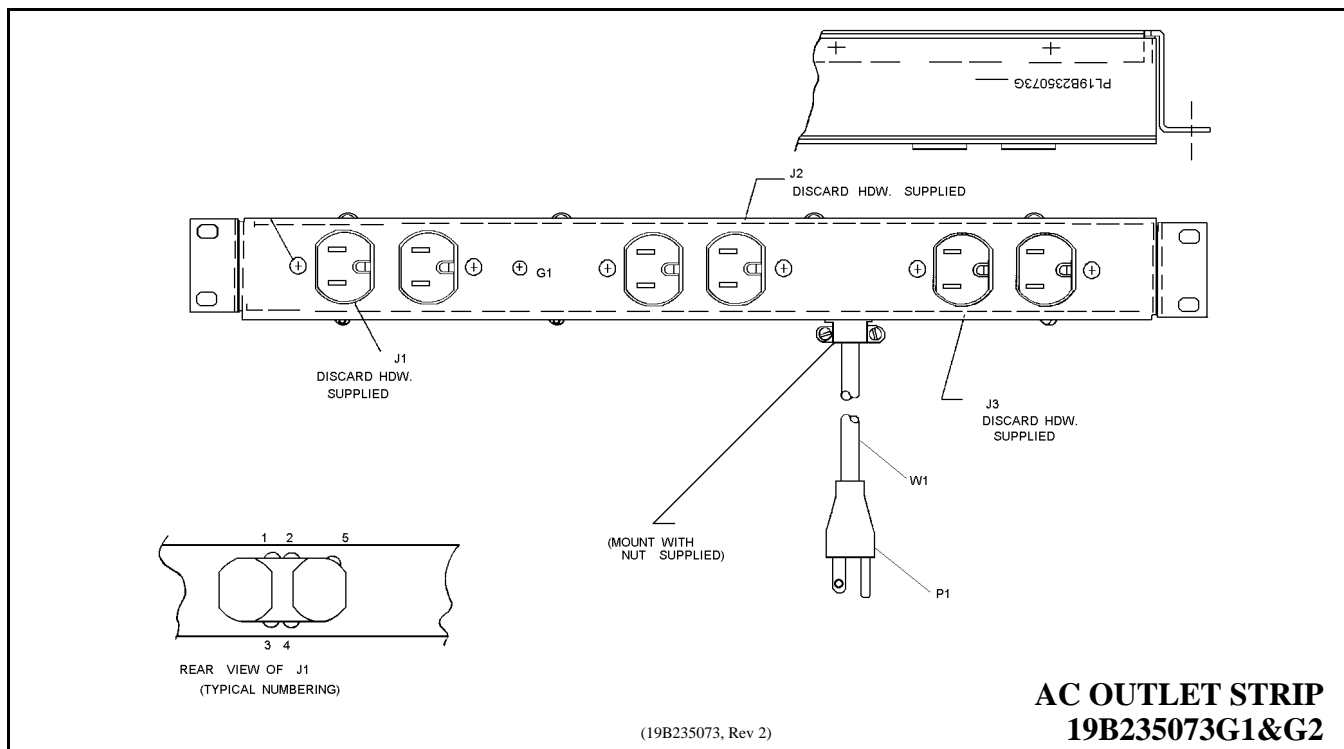

**AC OUTLET STRIP  
19B235073G1&G2**

OUTLINE DIAGRAM

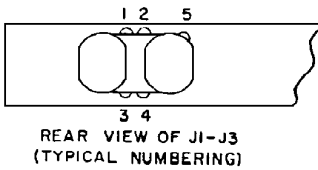
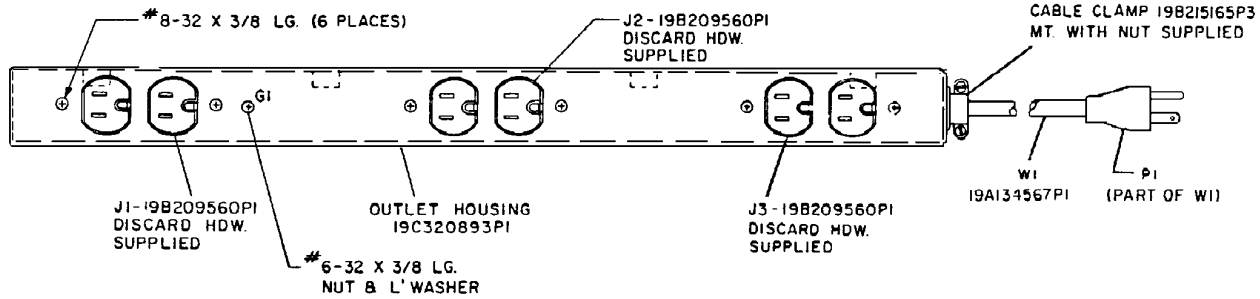

(19B226839, Rev. 1)

AC OUTLET STRIP  
19B226209G1

SCHEMATIC DIAGRAM

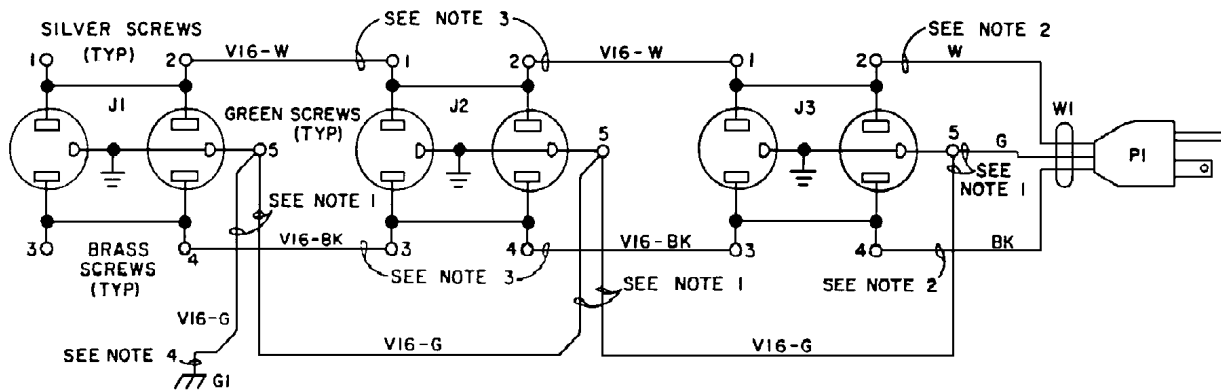

NOTES:

1. TERMINATE WITH 19B209260PI01.
2. TERMINATE WITH 19B209268P4.
3. TERMINATE WITH 19B209268P4 BOTH ENDS.
4. TERMINATE WITH 19B209260P4.

(19B226211, Rev. 2)

AC OUTLET STRIP  
19B226209G1  
19B235073G1&2

DESK MATE CABINET

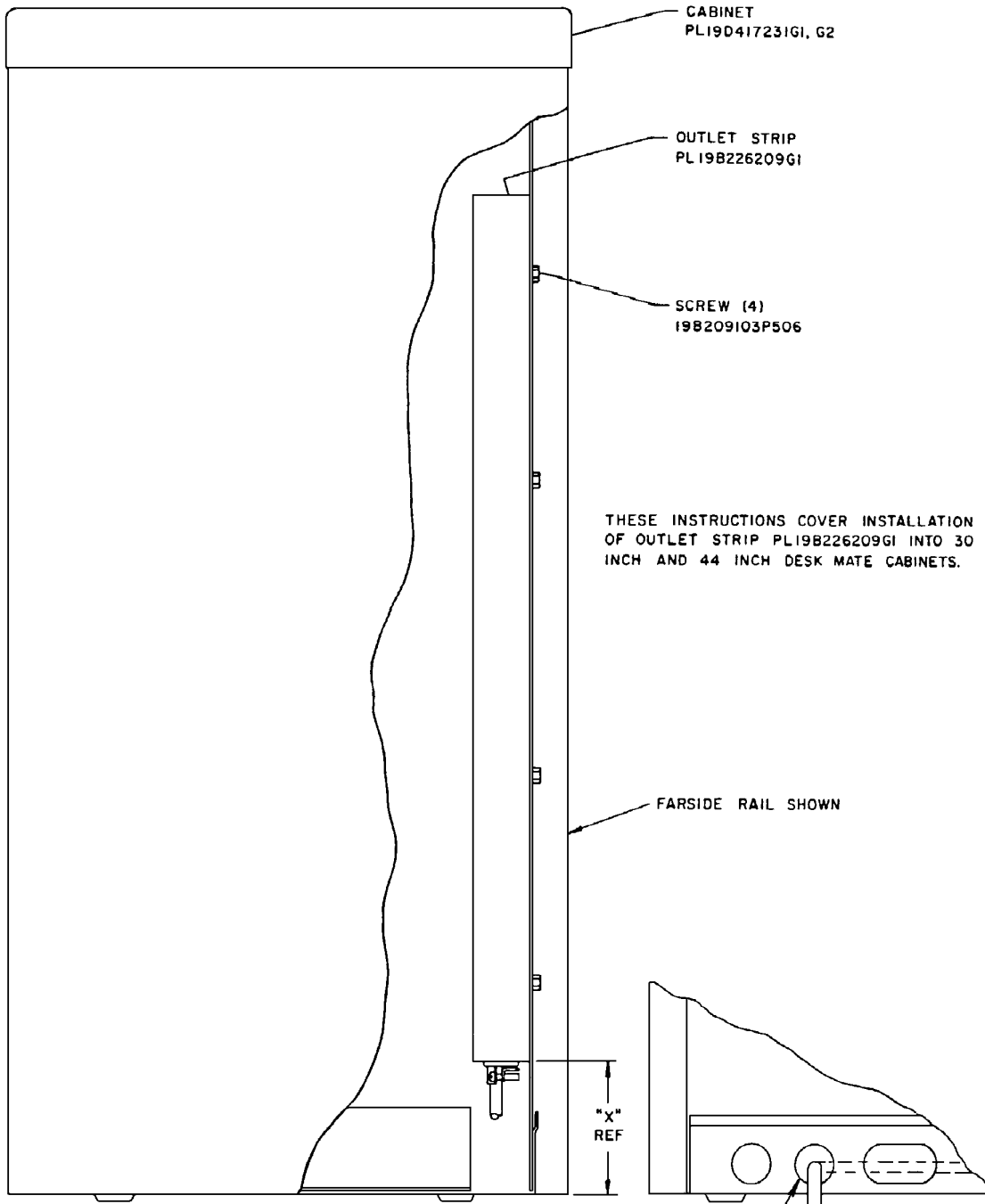

NOTE:

"X" DIM. FOR PL19D417231G1 CABINET IS 3.400  
"X" DIM. FOR PL19D417231G2 CABINET IS 17.400

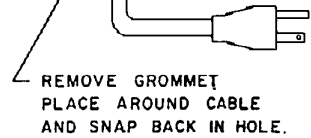

DESK MATE CABINET  
AC OUTLET STRIP

(19D417519, Rev. 2)

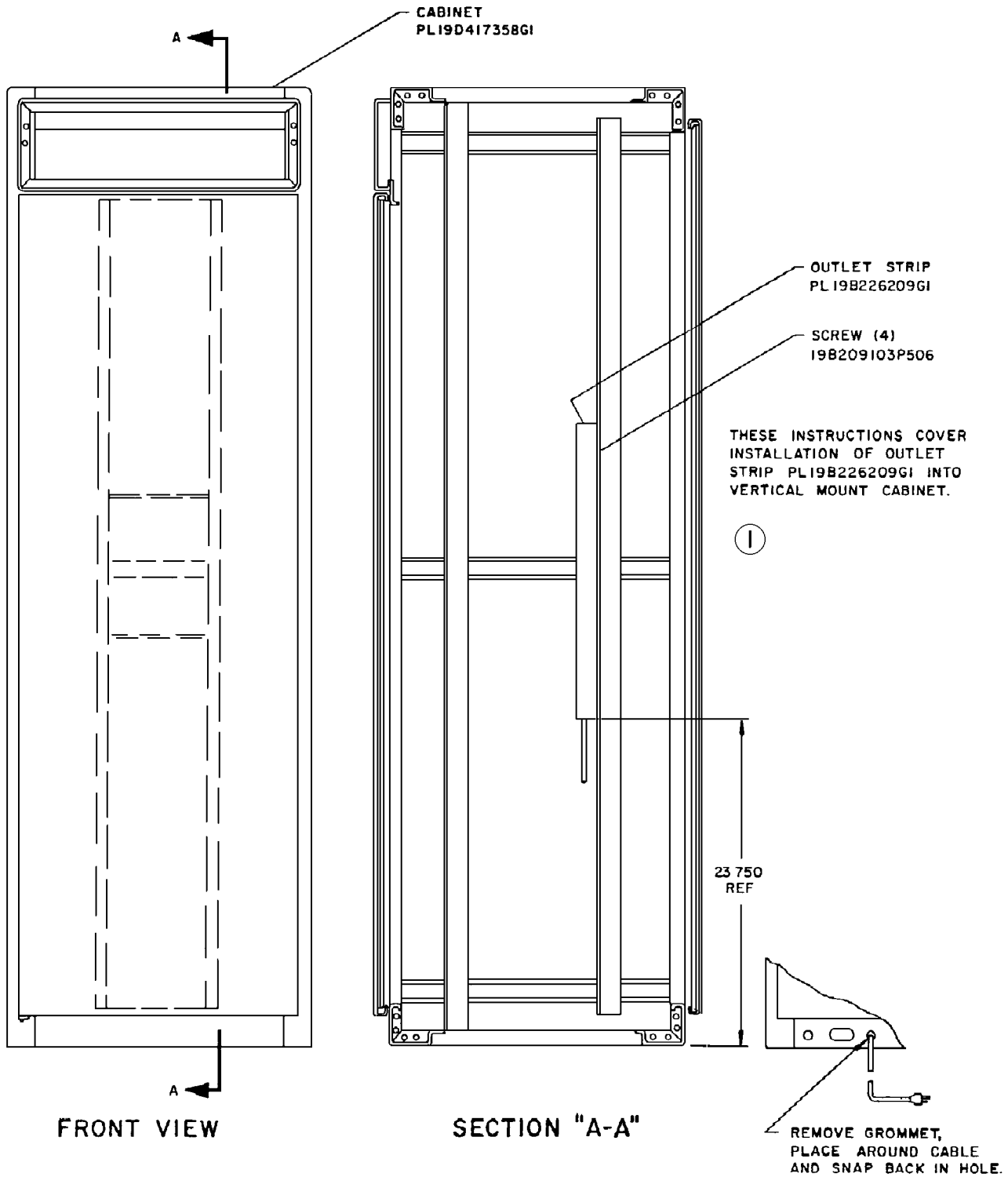

**VERTICAL MOUNT CABINET  
AC OUTLET STRIP**

(19D417519, Rev. 2)

**Ericsson Inc.**  
Private Radio Systems  
Mountain View Road  
Lynchburg, Virginia 24502  
1-800-528-7711 (Outside USA, 804-528-7711)