

# IC-03AT

220MHz FM TRANSCEIVER

INSTRUCTION MANUAL



## FOREWORD

Thank you very much for choosing this ICOM product.

The **IC-03AT** is a complete VHF handheld transceiver in one small, compact package developed by ICOM utilizing the latest computer technology and precision VHF engineering.

To fully enjoy the benefits of this high-performance transceiver, please study the instruction manual thoroughly prior to operation. Also, feel free to contact an authorized ICOM dealer if you have any questions relating to the operation of this model.

## UNPACKING

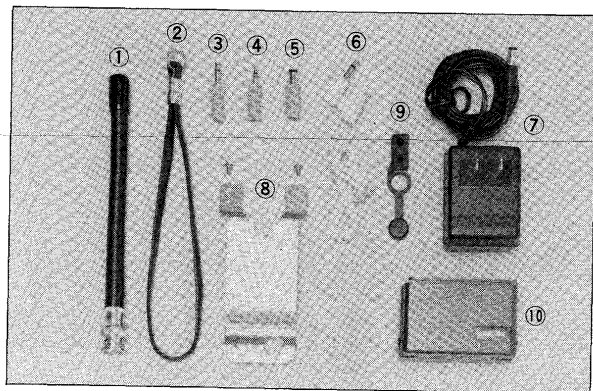

Accessories included with the IC-03AT	QTY.
① Flexible antenna . . . . .	1
② Hand strap . . . . .	1
③ Earphone plug . . . . .	1
④ Microphone plug . . . . .	1
⑤ DC power plug . . . . .	1
⑥ Earphone . . . . .	1
⑦ BC-25U WALL CHARGER . . . . .	1
⑧ Belt clip . . . . .	1
⑨ Rainproof cap . . . . .	1
⑩ IC-BP3 BATTERY PACK . . . . .	1

# TABLE OF CONTENTS

	<b>WARNINGS</b> . . . . .	1			
<b>SECTION</b>	<b>1 FEATURES</b> . . . . .	2			
<b>SECTION</b>	<b>2 CONTROL FUNCTIONS</b> . . . . .	3			
<b>SECTION</b>	<b>3 PRE-OPERATION</b> . . . . .	11			
	3-1 BATTERY INSTALLATION. . . . .	11			
	3-2 ANTENNA CONNECTION. . . . .	13			
	3-3 FOR OUTDOOR USE . . . . .	13			
<b>SECTION</b>	<b>4 GENERAL OPERATION</b> . . . . .	14			
	4-1 RECEIVING. . . . .	14			
	4-2 TRANSMITTING. . . . .	15			
	4-3 KEY FUNCTIONS. . . . .	17			
<b>SECTION</b>	<b>5 FUNCTIONS OPERATION</b> . . . . .	19			
	5-1 DIAL MODE AND MEMORY MODE . . . . .	19			
	5-2 SETTING FREQUENCY . . . . .	20			
	5-3 SETTING FREQUENCY STEP RATE . . . . .	21			
	5-4 DUPLEX OPERATION . . . . .	22			
	5-5 MEMORY WRITING . . . . .	23			
	5-6 MEMORY READING . . . . .	27			
	5-7 CALL CHANNEL OPERATION . . . . .	28			
	5-8 PRIORITY FUNCTION. . . . .	29			
	5-9 SCANNING OPERATION . . . . .	30			
	5-10 LOCK FUNCTION. . . . .	33			
	5-11 BEEP TONE ON/OFF FUNCTION . . . . .	33			
	5-12 DTMF OPERATION. . . . .	34			
	5-13 SETTING SUBAUDIBLE TONE ENCODER FREQUENCY . . . . .	34			
<b>SECTION</b>	<b>6 MAINTENANCE</b> . . . . .	36			
	6-1 CAUTIONS . . . . .	36			
	6-2 MALFUNCTIONS . . . . .	36			
<b>SECTION</b>	<b>7 INSIDE VIEWS</b> . . . . .	39			
<b>SECTION</b>	<b>8 TROUBLESHOOTING</b> . . . . .	41			
<b>SECTION</b>	<b>9 BLOCK DIAGRAM</b> . . . . .	43			
<b>SECTION</b>	<b>10 SPECIFICATIONS</b> . . . . .	44			
<b>SECTION</b>	<b>11 SCHEMATIC DIAGRAM</b> . . . . . SEPARATE				

## WARNINGS

● **AVOID** using the transceiver under the following conditions:

- In places subject to excessive heat or cold.  
(Usable temperature:  $-10^{\circ}\text{C} \sim +60^{\circ}\text{C}$ )
- In places subject to excessive dust.
- In places subject to excessive humidity, including bathrooms.
- In places subject to excessive vibrations.

● **BATTERY PACK NOTE**

The full charge capacity of NiCd rechargeable batteries may be reduced if repeatedly charged with only partial discharge periods. This is called the battery memory effect. If the battery capacity seems lower than when new, discharge the pack completely through normal use, then charge fully using the proper charger.

● **EXTERNAL POWER SOURCE  
NOTE**

If the IC-03AT is used continuously for 15 hours or more with an external DC power source connected to the top panel **EXTERNAL DC POWER JACK**; be sure to remove the battery pack from the transceiver to prevent overcharging.

## SECTION 1 FEATURES

### ●MOISTURE PROOF

The IC-03AT is ruggedly constructed with rubber gaskets between the transceiver covers and chassis, ensuring that moisture will never be a problem when operating in practically any environment.

### ●SLIDE-ON BATTERY PACK

The supplied IC-BP3 BATTERY PACK easily slides off and on the transceiver body for quick removal or attachment. Once attached it will stay in place due to a quick-release lock button designed to prevent accidental removal.

### ●10 MEMORY CHANNELS

The IC-03AT has ten memory channels which store operating frequency as well as duplex/simplex, duplex offset frequency, and subaudible tone frequency information for your operating convenience.

### ●MULTI-PURPOSE SCANNING

Memory scan allows you to monitor all memory channels. Programmed scan provides scanning between two programmed frequencies. Auto-stop is also provided which stops the scan when a signal is received, but allows the scan to resume when the signal goes away.

## SECTION 2 CONTROL FUNCTIONS

### TOP PANEL

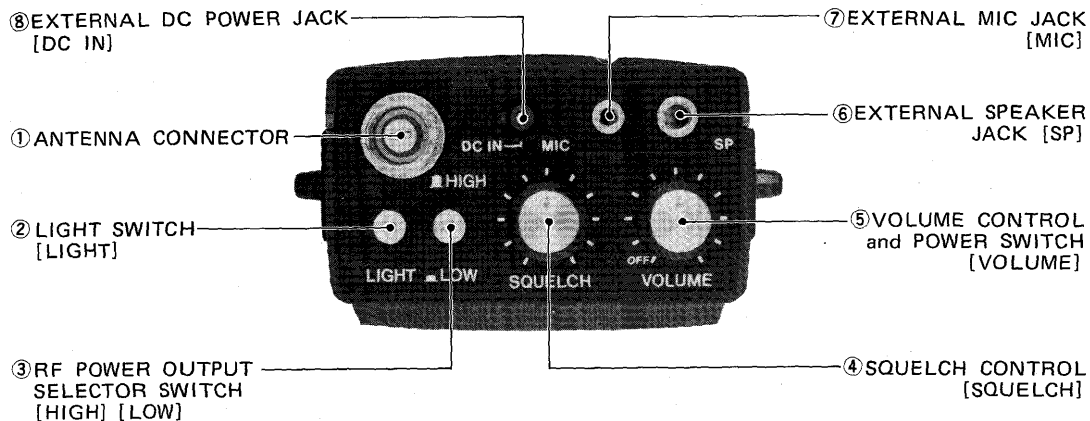

## FRONT PANEL



## REAR PANEL

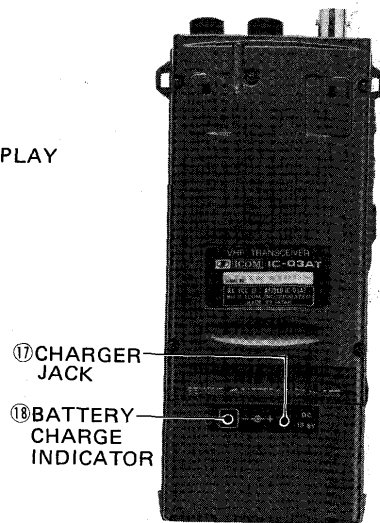

## ■ TOP PANEL

### ① ANTENNA CONNECTOR

Connect the supplied flexible antenna. All antennas connected to the transceiver must be  $50\Omega$  and have a BNC connector.

**CAUTION:** Transmitting without an antenna may damage the transceiver.

### ② LIGHT SWITCH [LIGHT]

Press this switch down to turn ON the backlight for the FREQUENCY DISPLAY.

### ③ RF POWER OUTPUT SELECTOR SWITCH [HIGH] [LOW]

Switches the output power of the transceiver between HIGH and LOW. In the HIGH (out) position, the output power is 2W at 8.4V. In the LOW (locked in) position, the output power is 0.5W at any voltage between 5.5 and 16V.

### ④ SQUELCH CONTROL [SQUELCH]

Raises the threshold level.

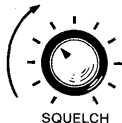

Sets the squelch threshold level. Rotate this control completely counterclockwise to turn OFF the squelch function, and clockwise to raise the threshold level.

### ⑤ POWER/VOLUME CONTROL [VOLUME]

Rotate this control clockwise to turn the transceiver ON and increase the audio level.



⑥ **EXTERNAL SPEAKER JACK**  
[SP]

Connect either an  $8\Omega$  external speaker or the supplied earphone for private listening. The INTERNAL SPEAKER will not operate if an external speaker is connected to the EXTERNAL SPEAKER JACK.

⑦ **EXTERNAL MICROPHONE**  
JACK [MIC]

The optional IC-HM9 SPEAKER-MICROPHONE or optional HS-10 HEADSET can be connected for additional versatility to the EXTERNAL MICROPHONE JACK. The internal microphone does not function when an external microphone is connected.

• **Dynamic microphone**

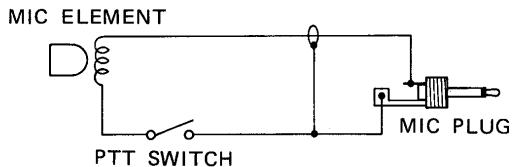

• **Electret condenser microphone**

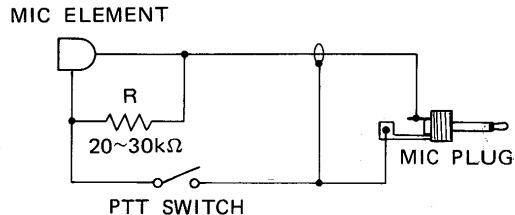

**⑧ EXTERNAL DC POWER JACK [DC IN]**

Connect the IC-CP1 CIGARETTE LIGHTER CABLE or external 13.8V DC power source to this jack for mobile operation. The battery pack does not need to be attached for the transceiver to operate. However, if the battery pack is attached, the battery pack will charge automatically.

The [DC IN] JACK accepts voltages between 12V and 15V. However, the transceiver does not work when supplying more than 16V.

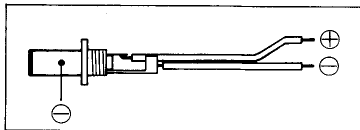

**NOTE:** If the IC-03AT is used continuously for 15 hours or more with an external DC power source connected to the top panel EXTERNAL DC POWER JACK, be sure to remove the battery pack from the transceiver to prevent overcharging.

**■ FRONT AND SIDE PANELS**

**⑨ FUNCTION SWITCH [FUNC]**

Push this SWITCH to select the secondary function of each key. See page 17.

**⑩ PUSH-TO-TALK SWITCH (PTT)**

Push this switch to begin transmitting.

**⑪ BATTERY PACK RELEASE BUTTON [RELEASE]**

Push the release button upwards, and slide the battery pack to the right to remove it from the IC-03AT.

## ⑫ FREQUENCY DISPLAY

The FREQUENCY DISPLAY indicates the operating frequency and several other functions as follows:

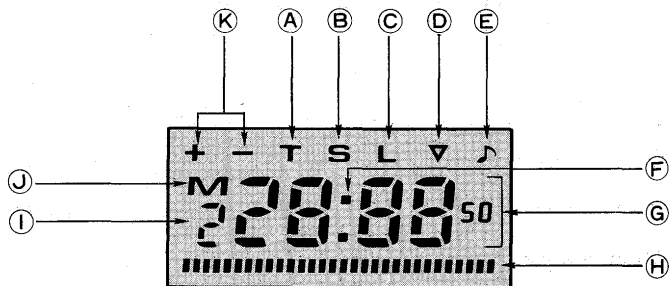

**(A) TRANSMIT INDICATOR  
"T"**

"T" appears when the transceiver is in the transmit mode.

**(B) SCAN INDICATOR "S"**

"S" appears when the transceiver is in a scan mode. See page 31.

**(C) LOCK INDICATOR "L"**

"L" appears when the operating frequency is locked. See page 33.

**(D) BATTERY CONDITION  
INDICATOR "▽"**

"▽" appears just before the battery is exhausted.

**(E) TONE ENCODER  
INDICATOR "♪"**

"♪" appears when the subaudible tone encoder is activated. See page 34.

**F PRIORITY FUNCTION INDICATOR “. ”**

“. ” appears when the transceiver is in the PRIORITY FUNCTION. See page 29.

**G FREQUENCY DISPLAY**

Illuminates the operating frequency from 100MHz to 10kHz. The small number “50” represents 5kHz.

**H S/R F INDICATOR  
“■■■■■■■■”**

Indicates signal strength in receive mode and RF power output level in transmit mode with a dotted bar. The RF power output level meter functions only as a relative output meter and does not indicate the power.

**I MEMORY CHANNEL INDICATOR**

\* See page 19 for DIAL MODE.

\*\* See page 27 for MEMORY MODE.

\*\*\*See page 28 for CALL CHANNEL OPERATION.

Indicates 100MHz digit of the operating frequency in \*DIAL MODE, and indicates a memory channel via the “M” indicator in \*\*MEMORY MODE.

In addition, “C” appears when the \*\*\*CALL CHANNEL is being called.

**J MEMORY MODE INDICATOR “M”**

“M” appears when the transceiver is in MEMORY MODE. See page 27.

**K DUPLEX MODE INDICATORS “+” “-”**

Appear while the IC-03AT is operating in DUPLEX MODE. Both indicators disappear while operating in SIMPLEX MODE. See page 22.

**⑬ KEYBOARD**

This keyboard has 16 keys consisting of ten numerical keys and six code keys. Some keys have dual functions. See page 17.

**⑭ INTERNAL SPEAKER**

The internal speaker operates when the transceiver is receiving. However, it will not operate if an external speaker is connected to the EXTERNAL SPEAKER JACK.

**⑮ INTERNAL MICROPHONE**

The internal microphone operates when the transceiver is transmitting. However, it will not operate if an external microphone is connected to the EXTERNAL MICROPHONE JACK.

**⑯ BATTERY PACK**

The IC-BP3 BATTERY PACK is a fully rechargeable NiCd battery pack that easily attaches to the IC-03AT.

**■ REAR PANEL**

**⑰ CHARGER JACK**

This jack accepts the output plug of the supplied BC-25U WALL CHARGER or suitable power sources.

**⑱ BATTERY CHARGE INDICATOR**

Lights up while battery pack is charging except when using the BC-35.

## SECTION 3 PRE-OPERATION

### 3 - 1 BATTERY INSTALLATION

#### (1) USING THE IC-BP3 BATTERY PACK

The supplied IC-BP3 BATTERY PACK is rechargeable and can be slipped ON or OFF the transceiver very easily.

To recharge the battery pack use the supplied BC-25U WALL CHARGER or the optional BC-35 AC BATTERY CHARGER, or a 12V-type cigarette lighter socket with the IC-CP1 CIGARETTE LIGHTER CABLE.

#### (2) BATTERY CHARGING

- 1) Use a suitable battery charger as shown at right or use a stable power source with an output voltage of DC 13.8V, or a 12V-type cigarette lighter socket with the optional IC-CP1.
- 2) It is not necessary for the IC-BP3 BATTERY PACK to be attached to the transceiver for recharging, but if it is, be sure that the POWER SWITCH on the transceiver is turned completely OFF before starting the charge.
- 3) It takes approximately 15 hours to charge the IC-BP3 BATTERY PACK completely.

## • CHARGER CONNECTIONS

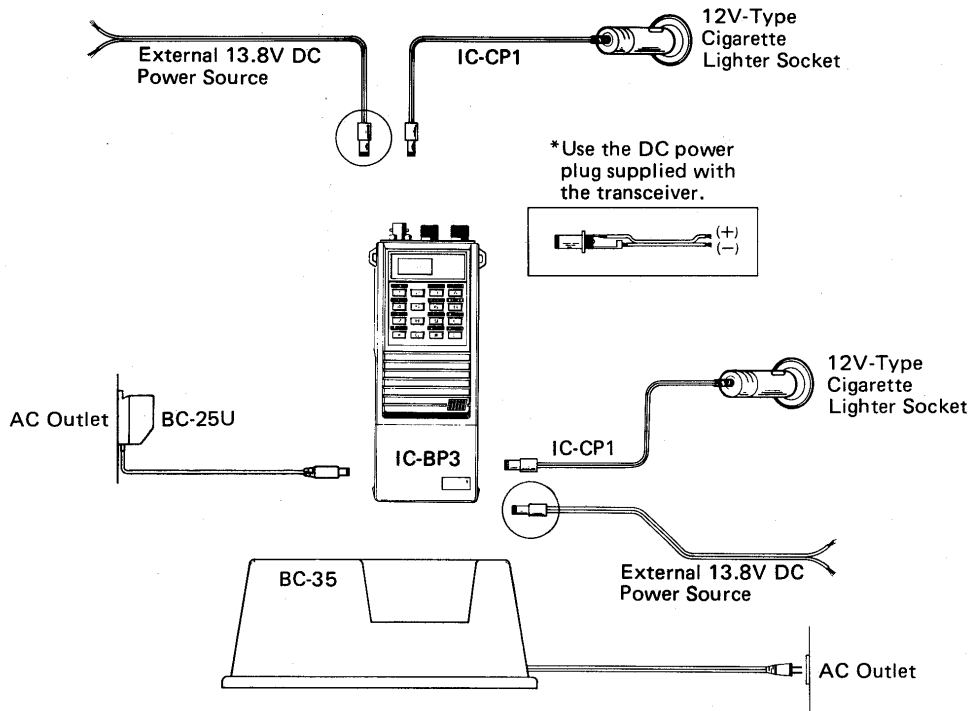

### 3-2 ANTENNA CONNECTION

Insert the connector on the flexible rubber antenna into the ANTENNA CONNECTOR on the top panel.

#### For external antenna connection:

- Select a high performance antenna and install it as high as possible.
- Use a 50Ω antenna and coaxial cable with BNC plug.

### 3-3 FOR OUTDOOR USE

- 1) Attach the belt clip to the rear panel using the two supplied screws and plastic washers.
- 2) Spread open and slide the ring of the hand strap over either of the projecting loops on the sides of the IC-03AT.

- Attach the belt clip on the rear panel with the 2 supplied screws.

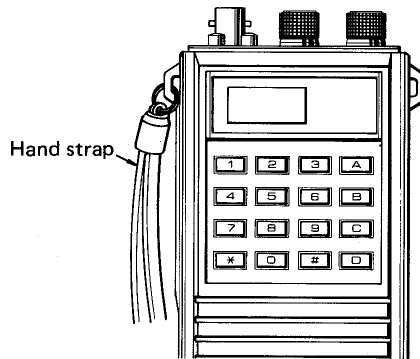
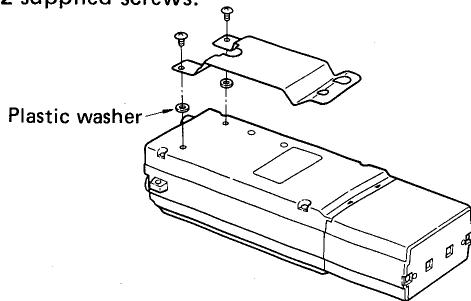



## SECTION 4 GENERAL OPERATION

### 4 - 1 RECEIVING

- 1) Turn power ON and adjust [VOLUME] CONTROL.

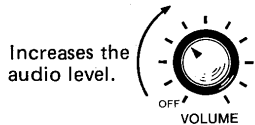

- 2) Adjust [SQUELCH] CONTROL.

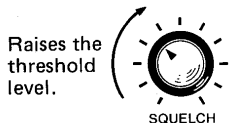

- 3) Set desired frequency.

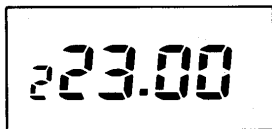

- 1) Turn power ON and adjust the [VOLUME] CONTROL to a suitable listening level.

- 2) Adjust the [SQUELCH] CONTROL until the noise is quieted.

- 3) To set an operating frequency for 223.000MHz, push four digit keys [3], [0], [0] and [0]. See page 20 for setting the frequency.

## 4 - 2 TRANSMITTING

1) Turn power ON.



2) Select output power.

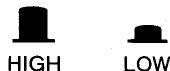

3) Select either simplex or duplex mode.

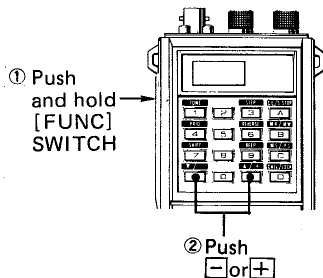

1) Turn power ON.

2) Select output power.

- [HIGH] : 2W (at 8.4V DC) 5W (at 13.8V DC)
- [LOW] : 0.5W

3) Select either simplex or duplex mode.

- Simplex mode:  
Transmit and receive frequencies are the same.
- +Duplex or -Duplex mode:  
Transmit and receive frequencies are normally different for 1.6MHz. See page 22 for setting offset the frequency.

4) Press [PTT] SWITCH.

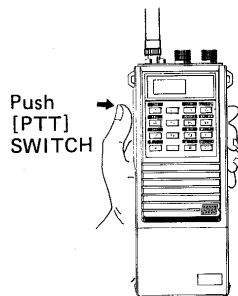

4) Press the [PTT] SWITCH to begin transmitting and speak into the microphone.

- RF INDICATOR appears and shows relative output power on the FREQUENCY DISPLAY.

[High power output]

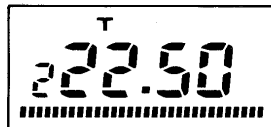

[Low power output]

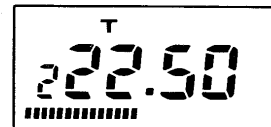

5) Set subaudible tone frequency.

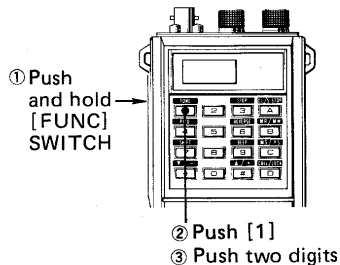



































5) Set the subaudible tone frequency to operate the repeater if required.

- Push and hold the [FUNC] SWITCH and push the [1]/[TONE] key and then push two digit keys to select a subaudible tone frequency number. See page 34.

## 4 - 3 KEY FUNCTIONS

Some keys have dual functions. To select the secondary function, push and hold the [FUNC] SWITCH, and then push the correct key for the function desired.

PRIMARY FUNCTIONS		SECONDARY FUNCTIONS	
KEY	FUNCTION	KEY	FUNCTION
	Sets the digit of 1.		Sets a desired subaudible tone or turns the tone ON/OFF. (p. 34)
	Sets the digit of 2.	-----	-----
	Sets the digit of 3.		Sets a desired frequency step. (p. 21)
	Sets the digit of 4.		Sets the PRIORITY FUNCTION. (p. 29)
	Sets the digit of 5.	-----	-----
	Sets the digit of 6.		In DUPLEX MODE, the transmit and receive frequencies are exchanged with each other. (p. 23)
	Sets the digit of 7.		Sets a desired receive/transmit offset frequency. (p. 22)
	Sets the digit of 8.	-----	-----
	Sets the digit of 9.		Turns ON and OFF the beep tone. (p. 33)
	Sets the digit of 0.	-----	-----

PRIMARY FUNCTIONS		SECONDARY FUNCTIONS	
KEY	FUNCTION	KEY	FUNCTION
	Decreases the operating frequency or operating memory channel number.	 	Sets the -Duplex in DUPLEX MODE. Push the key again to change to SIMPLEX MODE. (p. 22)
	Increases the operating frequency or operating memory channel number.	 	Sets the +Duplex in DUPLEX MODE. Push the key again to change to SIMPLEX MODE. (p. 22)
	Clears the entered number, and recalls previous frequency. Clears MEMORY MODE and selects DIAL MODE. Clears the PRIORITY FUNCTION. Clears any scan function and the operating frequency or memory channel stops on the displayed frequency.	 	Clears MEMORY MODE and the information in the memory channel is transferred to DIAL MODE.
	Sets the transceiver in MEMORY MODE. Push the key, then a desired channel number [0] to [9]. (p. 27)	 	Writes the displayed frequency into a memory channel. (p. 23)
	Sets the transceiver in MEMORY SCAN MODE. Scans all memory channels. (p. 31)	 	Sets the transceiver in PROGRAMMED SCAN MODE. (p. 32)
	Selects the frequency memorized in memory channel 3. At this time, the [A] key clears this function. (p. 28)	 	Cancels any key entries to prevent accidental key operation. To clear this function, press the [FUNC] SWITCH and push this key. (p. 33)

## SECTION 5 FUNCTIONS OPERATION

### 5 - 1 DIAL MODE AND MEMORY MODE

The IC-03AT has two different operating modes, DIAL MODE and MEMORY MODE. Each mode has the following functions:

#### (1) FUNCTIONS IN DIAL MODE

FUNCTION	PAGE
① Setting frequency	20
② Frequency up or down	21
③ Setting frequency step rate	21
④ Setting the BEEP ON/OFF function	33
⑤ Setting the subaudible tone encoder frequency	34
⑥ Setting DUPLEX MODE	22
⑦ Setting duplex offset frequency	22
⑧ Reversing TX and RX frequencies in DUPLEX MODE	23
⑨ Memory writing	23
⑩ Setting scan start in PROGRAMMED SCAN MODE	32

#### (2) FUNCTIONS IN MEMORY MODE

FUNCTION	PAGE
① Recalling the frequency memorized in a memory channel	27
② Memory channel up or down	28

### (3) FUNCTIONS IN BOTH DIAL AND MEMORY MODES

FUNCTION	PAGE
① Recalling the CALL CHANNEL	28
② Starting MEMORY SCAN	31
③ Starting the PRIORITY FUNCTION	29
④ Setting the LOCK ON/OFF FUNCTION	33

## 5 - 2 SETTING FREQUENCY

### (1) USING DIGIT KEYS

- 1) To set an operating frequency, push the appropriate digit keys for the desired frequency.
- 2) If illegal digits or an out-of-band frequency have been entered, the digits are cancelled and the previous operating frequency will be recalled.
- 3) When a wrong key has been pushed, press the [A]/[CL] key. The entered digits are cancelled and the previous operating frequency will be recalled.

#### (FREQ. SET) EXAMPLE:

Setting the frequency at 222.385MHz.

Press keys

2

3

8

5

Display

222

2223

22238

222.38<sup>50</sup>

## (2) USING [▲] OR [▼] KEY

- 1) Push the [#]/[▲] or [\*]/[▼] key, and the operating frequency will increase or decrease with the frequency step rate.
- 2) In the same way, holding the key down, shift the operating frequency up or down continuously.

**[▲][▼] EXAMPLE:** Setting the frequency with the frequency step rate pre-set at 10kHz.

Press keys					
	#	#	*	*	
Display	222.38 <sup>50</sup>	222.39 <sup>50</sup>	222.40 <sup>50</sup>	222.39 <sup>50</sup>	222.38 <sup>50</sup>

## 5 - 3 SETTING FREQUENCY STEP RATE

Push and hold the [FUNC] SWITCH, push [3]/[STEP] key and then push a key to determine the step rate. The frequency step rate allocated to each key is as follows:

[1]	[2]	[3]	[4]	[5]	UNIT
5	10	15	20	25	kHz

**[STEP] EXAMPLE:** Setting the frequency step rate at 5kHz.

Press keys	(Hold down)			(Release)
		3	1	
Display	222.42 <sup>50</sup>	2	1	222.42 <sup>50</sup>



## 5 - 4 DUPLEX OPERATION

Transmit offset refers to the frequency difference between the receive and transmit frequencies when using DUPLEX MODE.

### (1) SETTING THE OFFSET FREQUENCY

- 1) Push and hold the [FUNC] SWITCH, push the [7]/[SHIFT] key, then the four digit keys of the desired offset frequency.
- 2) If illegal digits have been entered, the digits are cancelled.

<b>[SHIFT] EXAMPLE:</b>		Setting the offset frequency at 1.6MHz.					
Press keys	(Hold down) <b>FUNC</b>	<b>SHIFT</b> 7	1	6	0	0	(Release) <b>FUNC</b>
Display	224.58	0.01	1	16	160	160	224.58

### (2) SETTING DUPLEX MODE

- 1) Push and hold the [FUNC] SWITCH, then push the [-] or [+] key for DUPLEX MODE or the same keys again to return to SIMPLEX MODE.
  - “-” or “+” appears on the FREQUENCY DISPLAY.

<b>[DUP] EXAMPLE:</b>		Setting the -Duplex in DUPLEX MODE.		
Press keys	(Hold down) <b>FUNC</b>	<b>-</b>	(Release) <b>FUNC</b>	
Display	224.58	224.58	224.58	

### (3) REVERSE DUPLEX

To reverse the transmit and the receive frequencies in DUPLEX MODE, push and hold the [FUNC] SWITCH and push the [6]/[REVERSE] key.

<b>[REVERSE] EXAMPLE:</b>	Reversing the transmit and receive frequencies in DUPLEX MODE with the offset frequency pre-set at 1.6MHz.
Press keys	(Hold down) <b>REVERSE</b> [FUNC] [6] (Hold down) <b>REVERSE</b> [FUNC] [6]
Display	224.58 222.98 224.58

### 5 - 5 MEMORY WRITING

The IC-03AT can memorize a frequency, DUPLEX MODE, its offset frequency, and tone number into a memory channel.

- 1) Set the desired frequency, DUPLEX MODE, etc., with the procedures described previously.
- 2) Push and hold the [FUNC] SWITCH, push the [B]/[MW] key, followed by a digit key which has the same number as the memory channel number.
- 3) The transceiver has 10 memory channels, memory channels 0 to 9. Some are special channels as described below.

●M1 (MEMORY CHANNEL 1)

SHIFT

STONE

The offset frequency for duplex operation in M1 is the offset frequency and subaudible tone frequency applied to memory channels M2 to M6. That is, M2 to M6 has the same offset and tone frequencies as those entered in M1.

●M2

No special function is available.

●M3

CALL

The frequency memorized in M3 can be recalled by pushing the [D]/[CALL] key.

●M4

PRIOR

The frequency memorized in M4 is the priority frequency in the PRIORITY FUNCTION.

●M5 and M6

PS

The frequencies memorized in M5 and M6 are the limits of the PROGRAMMED SCAN range. Regardless of which channel the higher frequency is memorized in, the scan starts from the frequency memorized in M5.

●M7, M8, M9 and M0

SHIFT

STONE

The offset frequency and subaudible tone number can be memorized into each memory channel independently.

**[MW] EXAMPLE:**

Memorizing the following information into memory channel 1 (M1).

- (1) Frequency . . . . . 224.580MHz
- (2) Subaudible tone encoder frequency . . . . . 88.5Hz
- (3) Offset frequency . . . . . 1.6MHz
- (4) Operating mode . . . . . -Duplex
- (5) Memory channel . . . . . M1

(1) Setting frequency at 224.580MHz.

Press keys

Display

(2) Setting the subaudible tone encoder frequency at 88.5Hz.

Press keys

(Hold down)  (Release)

Display

(3) Setting the offset frequency at 1.6MHz.

Press keys (Hold down) **SHIFT** (Release)  
**FUNC** **7** **1** **6** **0** **0** **FUNC**

Display  $\bar{2}24.58^{\wedge}$   $\bar{0.01}^{\wedge}$   $\bar{1}^{\wedge}$   $\bar{16}^{\wedge}$   $\bar{160}^{\wedge}$   $\bar{160}^{\wedge}$   $\bar{2}24.58^{\wedge}$

(4) Setting the DUPLEX MODE at -Duplex.

Press keys (Hold down) **V/-** (Release)  
**FUNC** **\*** **FUNC**

Display  $\bar{2}24.58^{\wedge}$   $\bar{2}24.58^{\wedge}$   $\bar{2}24.58^{\wedge}$

(5) Memorizing the above information into M1.

Press keys (Hold down) **MR/MW** (Release)  
**FUNC** **B** **1** **FUNC**

Display  $\bar{M}24.58^{\wedge}$   $\bar{M}24.58^{\wedge}$   $\bar{2}24.58^{\wedge}$

## 5 - 6 MEMORY READING

- 1) Push the [B]/[MR] key then a digit key corresponding to the same number as the memory channel that contains the desired frequency.

The DUPLEX MODE and the subaudible tone number also can be recalled at the same time if they have been memorized.

- 2) "M" and the memory channel number appear on the FREQUENCY DISPLAY.

### [MR] EXAMPLE 1:

Recalling the frequency memorized in M1.

Press keys

MR/MW

B

1

Display

24.84

M24.84

M24.58

### [MR] EXAMPLE 2:

Changing memory channels.

Press keys

5

6

0

1

Display

M24.58

M23.80

M24.98

M23.50

M24.58

**[MR] EXAMPLE 3:**

Changing memory channels using [▲] or [▼] key.

Press keys



Display

M24.58

M24.68

M24.10

M24.68

M24.58

● **[CL] key notes in memory mode**

1) By pushing the [A]/[CL] key, MEMORY MODE is cleared and the transceiver returns to DIAL MODE.

2) While pushing the [FUNC] SWITCH, push the [A]/[CL] key. MEMORY MODE is then cleared and the information in the memory channel is transferred to DIAL MODE.

**5 - 7 CALL CHANNEL OPERATION**

1) Push the [D]/[CALL] key. "C" appears and the CALL CHANNEL recalls the frequency memorized in memory channel 3.

2) To clear the CALL CHANNEL function, push the [A]/[CL] key. The previously displayed frequency is recalled on the FREQUENCY DISPLAY.

**NOTE:** At this time, all key functions except the [CL] and [LOCK] functions are disabled.

**[CALL] EXAMPLE:**

Recalling the CALL CHANNEL memorized in M3.

Press key

CALL/LOCK



Display

224.84

224.10

## 5 - 8 PRIORITY FUNCTION

The PRIORITY FUNCTION checks another frequency such as a local repeater or calling frequency.

- 1) Memorize your favorite frequency into memory channel 4.
- 2) Set the desired operating frequency.
- 3) Push and hold the [FUNC] SWITCH and push the [4]/[PRIO] key.
  - The transceiver receives on the operating frequency for a period of five seconds and on the priority channel for one second.
  - A dot appears above the decimal point to show the transceiver is in the PRIORITY FUNCTION.

**NOTE:** In the PRIORITY FUNCTION, all keys, except the [A]/[CL] key, are disabled.



4) If the [PTT] SWITCH is pushed during the PRIORITY FUNCTION, the transmit frequency will be the operating frequency. When the [PTT] SWITCH is released, the PRIORITY FUNCTION will continue.

5) To clear the PRIORITY FUNCTION, push the [A]/[CL] key.

**[PRIO] EXAMPLE:** Setting the PRIORITY FUNCTION at 224.84MHz. The memory channel 4 is 223.35MHz.

Press keys: (Hold down) **FUNC** **PRIO** (Release keys) **4** (Push PTT)

Display: 224.84    223:35    224.84    223:35    224.84

## 5 - 9 SCANNING OPERATION

The IC-03AT provides MEMORY SCAN and PROGRAMMED SCAN operation.

TYPE OF SCAN	FUNCTION
MEMORY SCAN	Continuously scans all ten memory channels in order.
PROGRAMMED SCAN	Scans between two desired frequencies that are memorized in M5 and M6.

## (1) MEMORY SCAN

- 1) Memorize ten desired frequencies into memory channels 0 to 9.
- 2) Adjust the [SQUELCH] CONTROL to quiet the noise output from the speaker.
- 3) Push the [C]/[MS] key to start the scan.
  - "S" appears on the FREQUENCY DISPLAY and the scan starts.
- 4) The scan stops when a signal is received. The scan will resume after the signal goes away.
- 5) To clear the scan function, push the [A]/[CL] key or [PTT] SWITCH, and the scan stops on the memory channel displayed.
  - "S" disappears on the FREQUENCY DISPLAY.

**NOTE:** When the transceiver is in MEMORY SCAN MODE, all keys except the [A]/[CL] key are disabled.

### [MS] EXAMPLE:

Operating MEMORY SCAN.

Press key



Display

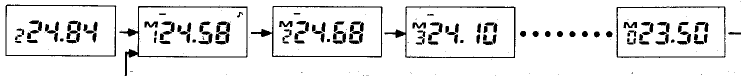

## (2) PROGRAMMED SCAN

- 1) Store the frequencies of the upper and lower limits of the desired scan range into either M5 or M6.
- 2) Set the IC-03AT in DIAL MODE by pushing the [A]/[CL] key if the transceiver is in MEMORY MODE.
- 3) Adjust the [SQUELCH] CONTROL to quiet the noise output from the speaker.
- 4) Push and hold the [FUNC] SWITCH and push the [C]/[PS] key. The scan starts from the frequency memorized in M5 and moves towards the frequency memorized in M6.
  - The scanning frequency increments depend on the frequency step rate setting. See page 21.
- 5) Any signal which opens the squelch when it is engaged stops the scan automatically and the transceiver locks onto the frequency.
- 6) To clear the scan function, push the [A]/[CL] KEY or [PTT] SWITCH to revert to the transmit mode.
  - The scan stops on the frequency displayed.
  - "S" disappears on the FREQUENCY DISPLAY.

**NOTE:** When the transceiver is in PROGRAMMED SCAN MODE all keys except the [A]/[CL] key are disabled.

**[PS] EXAMPLE:**

Operating PROGRAMMED SCAN with the frequency step rate pre-set at 10kHz.

Frequency in M5. . . . . 223.800MHz  
Frequency in M6. . . . . 223.980MHz

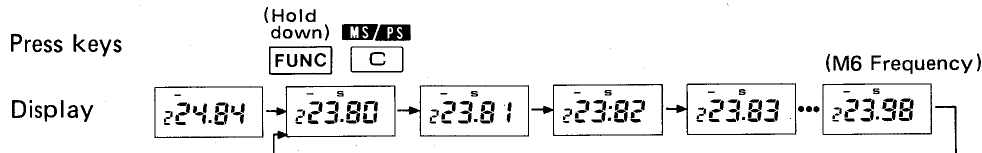

**5 - 10 LOCK FUNCTION**

This function prevents accidental frequency and function changes.

- 1) Push and hold the [FUNC] SWITCH and push the [D]/[LOCK] key.
  - "L" appears on the FREQUENCY DISPLAY.
  - At this time, all keys are disabled.
- 2) To clear the LOCK FUNCTION, push and hold the [FUNC] SWITCH and push the [D]/[LOCK] key again.

**5 - 11 BEEP TONE ON/OFF FUNCTION**

- 1) Push and hold the [FUNC] SWITCH and push the [9]/[BEEP] key to turn the BEEP TONE FUNCTION ON and OFF alternately.
- 2) When the BEEP TONE FUNCTION is ON, the beep sounds each time a key is pushed.

## 5 - 12 DTMF OPERATION

If you need DTMF tones to access a repeater or to make an auto phone-patch, follow the procedure below.

- 1) Push a key while pressing the [PTT] SWITCH, then continue to push keys without pressing the [PTT] SWITCH.
- 2) After pushing a key, the transmit mode is maintained for about one second.

## 5 - 13 SETTING SUBAUDIBLE TONE ENCODER FREQUENCY

The tone encoder allows access to repeaters which require a subaudible tone superimposed on the transmit signal in order to open the repeater station.

- 1) While pushing the [FUNC] SWITCH, push the [1]/[TONE] key then the two digit keys for the tone number. Refer to the SUB-AUDIBLE TONE ENCODER FREQUENCY TABLE as shown on page 35.

The "♪" indicator appears on the FREQUENCY DISPLAY while the tone encoder is being activated.

- 2) If an illegal number has been entered, the number is cancelled and the previous number will be recalled.
- 3) To turn OFF the tone encoder, push the [1]/[TONE] key while the [FUNC] SWITCH is pushed. The "♪" indicator will disappear.

**[TONE] EXAMPLE:**

Setting the subaudible tone encoder frequency at 88.5Hz. (See table below.)

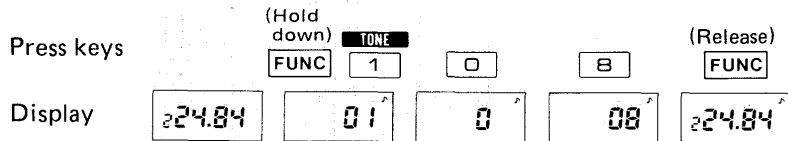

●SUBAUDIBLE TONE ENCODER FREQUENCY TABLE

TONE NUMBER	FREQUENCY (Hz)	TONE NUMBER	FREQUENCY (Hz)	TONE NUMBER	FREQUENCY (Hz)
01	67.0	14	107.2	27	167.9
02	71.9	15	110.9	28	173.8
03	74.4	16	114.8	29	179.9
04	77.0	17	118.8	30	186.2
05	79.7	18	123.0	31	192.8
06	82.5	19	127.3	32	203.5
07	85.4	20	131.8	33	210.7
08	88.5	21	136.5	34	218.1
09	91.5	22	141.3	35	225.7
10	94.8	23	146.2	36	233.6
11	97.4	24	151.4	37	241.8
12	100.0	25	156.7	38	250.3
13	103.5	26	162.3	---	-----

## SECTION 6 MAINTENANCE

### 6 - 1 CAUTIONS



Avoid the use of strong cleaning agents such as benzine or alcohol as they may damage the surfaces.

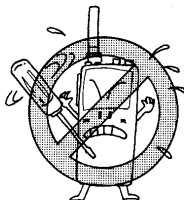

DO NOT disassemble the transceiver as it may cause trouble.

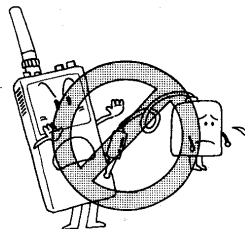

DO NOT use any chargers other than the suggested ones.

### 6 - 2 MALFUNCTIONS

#### (1) UNLOCKED PLL

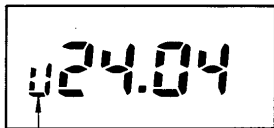

"U" appears

If a small "U" appears on the FREQUENCY DISPLAY as shown at the left, the PLL (Phase-Locked Loop) circuit in the transceiver is unlocked.

At this time, the transceiver is muted and no signals are transmitted. This unlocked condition may be caused by an exhausted battery pack, so check your battery pack first.

## (2) RESETTING INTERNAL MICROCOMPUTER (CPU)

**CAUTION:** After resetting the CPU, all information you have programmed into the memory channels will be cleared. Memory channels must be re-programmed.

Occasionally, the FREQUENCY DISPLAY may display erroneous information either during operation or when first applying power. This may, for example, be due to an external cause such as static electricity.

When this sort of problem occurs, simply reset the internal CPU according to the following procedures:

- 1) Turn power OFF.
- 1) Rotate the POWER/VOLUME CONTROL counterclockwise to the OFF position.
- 2) Hold down [FUNC] and turn power ON.
- 2) Hold down the [FUNC] SWITCH and then rotate the POWER/VOLUME CONTROL to the ON position.
- 3) The CPU is now reset. All memory channel frequencies and the displayed frequency are reset at their initialized values.



### (3) CPU BACKUP BATTERY

The IC-03AT uses a highly reliable CPU which is a complete, self-contained microprocessor. The purpose of the battery is to provide power to the CPU so it retains all memory information during power failures or in case the power pack is detached or turned OFF.

The usual life of the backup battery is approximately five years. Monitor the backup battery carefully and replace it if there are repeated cases of display malfunction.

**NOTE:** Battery replacement should be done by your nearest authorized ICOM Service Center.

- If the internal backup battery is exhausted, the IC-03AT transmit and receive functions will still operate normally but no frequencies can be memorized in the memory channels.

# SECTION 7 INSIDE VIEWS

## MAIN UNIT

## PLL UNIT

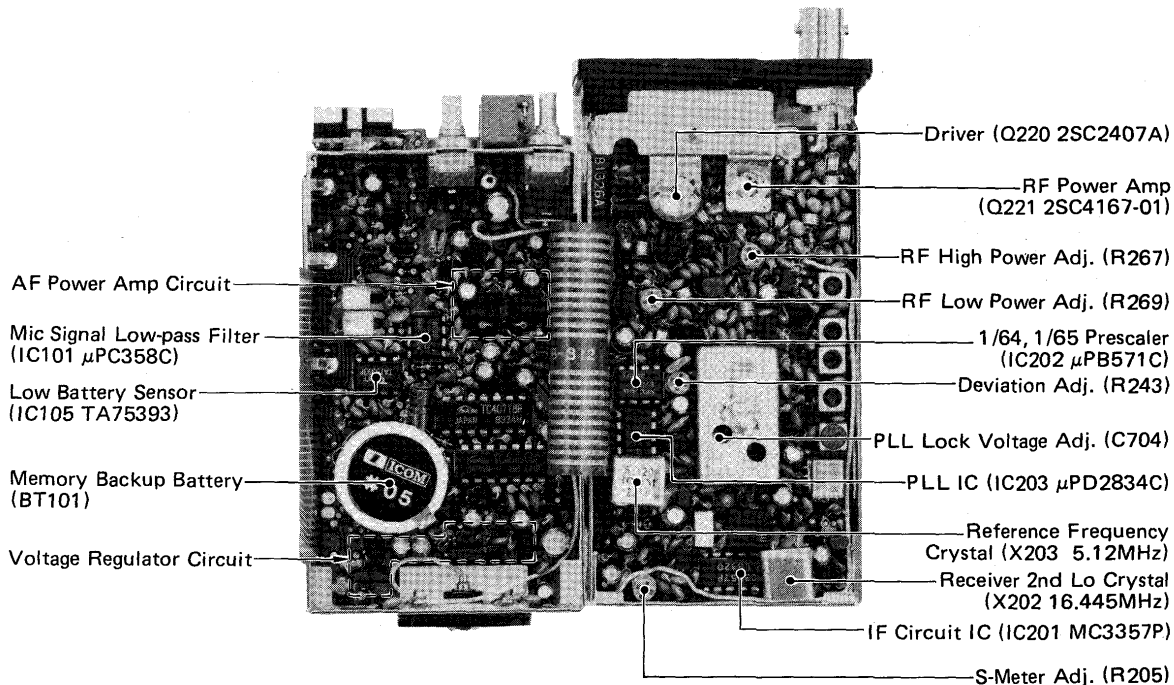

## TONE UNIT

Subaudible Tone Level  
Adj. (R510)

DTMF Level Adj. (R507)

CTCSS Encoder  
(IC503 S7116A)

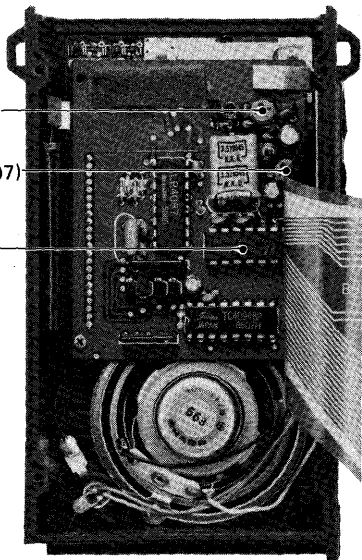

## LOGIC UNIT

Initial Matrix

MPU  
(IC401 HD44795)

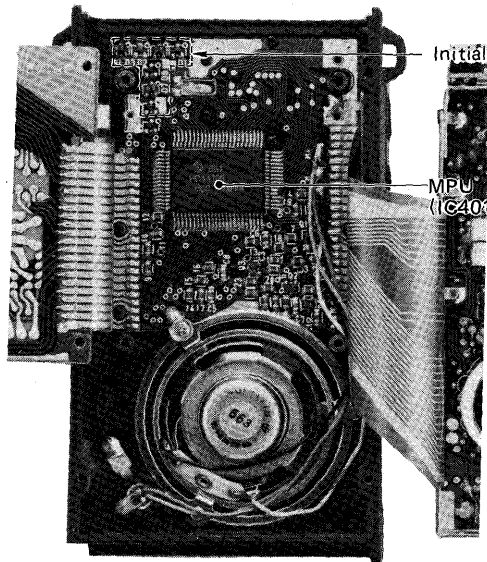

## SECTION 8 TROUBLESHOOTING

PROBLEM	POSSIBLE CAUSE	SOLUTION
1. Power does not come ON when the [POWER] SWITCH is turned.	<ul style="list-style-type: none"><li>• Bad connection of the battery pack to the transceiver.</li><li>• The battery pack is exhausted.</li></ul>	<ul style="list-style-type: none"><li>• Check the connection of the battery pack and correct any problems.</li><li>• Replace the battery pack with a new one or recharge it.</li></ul>
2. No sound comes from the speaker.	<ul style="list-style-type: none"><li>• Squelch setting is turned too far clockwise.</li><li>• External speaker or earphone is in use.</li><li>• The battery pack is exhausted.</li></ul>	<ul style="list-style-type: none"><li>• Turn the [SQUELCH] CONTROL counterclockwise until noise can be heard. Turn clockwise so the noise just disappears.</li><li>• Check if the external speaker plug is inserted properly or if the external speaker cable is cut.</li><li>• Replace the battery pack with a new one or recharge it.</li></ul>
3. Receive sensitivity is low and only strong signals are audible.	<ul style="list-style-type: none"><li>• Bad connection of the flexible antenna.</li><li>• The antenna feedline is cut or shorted (when using an external antenna).</li></ul>	<ul style="list-style-type: none"><li>• Check the connection of the antenna and correct any problems.</li><li>• Check the feedline and correct any improper condition.</li></ul>

PROBLEM	POSSIBLE CAUSE	SOLUTION
4. No or low power output.	<ul style="list-style-type: none"> <li>• RF POWER OUTPUT SELECTOR SWITCH is in the [LOW] position.</li> <li>• The battery pack is exhausted.</li> <li>• The antenna feedline is cut or shorted (when using an external antenna).</li> </ul>	<ul style="list-style-type: none"> <li>• Set the RF POWER OUTPUT SELECTOR SWITCH to [HIGH] position.</li> <li>• Replace the battery pack with a new one or recharge it.</li> <li>• Check the antenna feedline and correct any problems.</li> </ul>
5. No modulation (when using an external microphone).	<ul style="list-style-type: none"> <li>• Bad connection of the microphone plug.</li> </ul>	<ul style="list-style-type: none"> <li>• Check the connection of the microphone plug and correct any problems.</li> </ul>
6. PROGRAMMED SCAN does not function.	<ul style="list-style-type: none"> <li>• The transceiver is in MEMORY MODE.</li> <li>• The frequencies memorized in M5 and M6 are the same, or their difference is less than the frequency step rate.</li> </ul>	<ul style="list-style-type: none"> <li>• Push the [A]/[CL] key to set in DIAL MODE.</li> <li>• Memorize frequencies with a larger step rate than those currently set in M5 and M6.</li> </ul>
7. All key functions are disabled.	<ul style="list-style-type: none"> <li>• The LOCK FUNCTION is engaged.</li> <li>• The CALL FUNCTION is engaged.</li> </ul>	<ul style="list-style-type: none"> <li>• Clear the LOCK FUNCTION by pressing IN the [FUNC] SWITCH and pushing the [D]/[LOCK] key.</li> <li>• Clear the CALL FUNCTION by pushing the [A]/[CL] key.</li> </ul>

# SECTION 9 BLOCK DIAGRAM

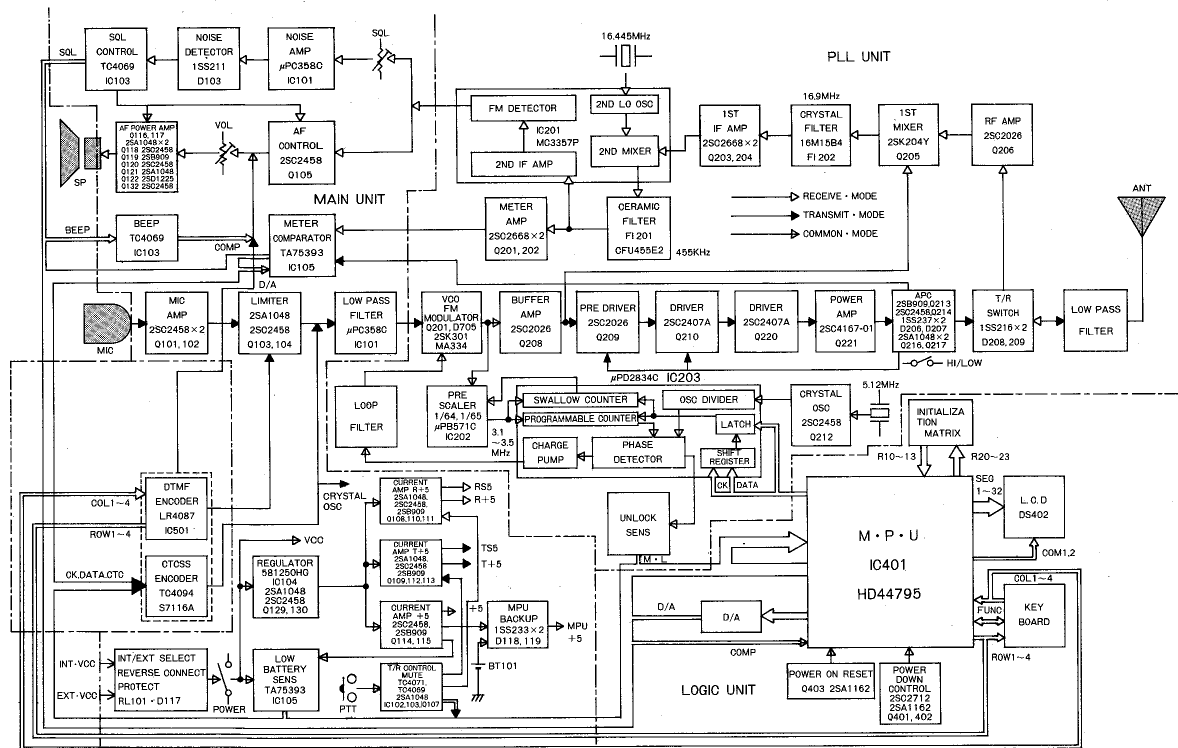

## SECTION 10 SPECIFICATIONS

### GENERAL

- Frequency coverage : 220.000 ~ 224.995MHz
- Antenna impedance : 50Ω unbalanced
- Usable temperature : -10°C ~ +60°C
- Frequency stability : ±20ppm at -10°C ~ +60°C
- Current drain at 13.8V DC : Receiving Squelched Approx. 50mA  
At max. audio output Approx. 170mA
- Transmitting HIGH (5W) Approx. 1.8A  
LOW (0.5W) Approx. 0.7A
- Dimensions (with IC-BP3) : 64(74)W x 158(169)H x 35(41)D mm  
Bracketed values include projections.
- Weight : 515g
- Power supply requirement : DC 5.5V ~ 16V negative ground is acceptable.  
(The [DC IN] JACK accepts DC11 ~ 16V)

### TRANSMITTER

- Output power : HIGH 2.0W (at 8.4V) 5.0W (at 13.8V) LOW 0.5W
- Emission mode : F3E (16K0F3E)
- Modulation system : Variable reactance frequency modulation
- Max. frequency deviation : ±5kHz
- Spurious emission : More than 60dB below carrier

### RECEIVER

- Modulation acceptance : F3E (16K0F3E)
- Sensitivity : Less than 0.25μV for 12dB SINAD
- Squelch sensitivity (Threshold) : Less than 0.1μV
- Spurious response rejection ratio : More than 60dB
- Audio output power : More than 500mW at 10% distortion with an 8Ω load
- Audio output impedance : 8Ω
- Receiving system : Double-conversion superheterodyne
- Intermediate frequencies : 1st 16.9MHz 2nd 455kHz



**ICOM INCORPORATED**

1-6-19, KAMIKURATSUKURI, HIRANO-KU  
OSAKA 547, JAPAN

A-0858  
Printed in Japan