



Receiver Model Table

Model	Frequency (MHz)	Description	Application
TRD6291A	132-150.8	Multi-Frequency 10.7 MHz I-F, Non-Filtered	Used with Single Receiver Stations
TRD6292A	146-174		
TRD6301A	132-150.8	Multi-Frequency 10.7 MHz I-F, Filtered	Used with 2-Receiver Stations and Repeater Stations
TRD6302A	146-174		
TRD6311A	132-150.8	Multi-Frequency 10.8 MHz I-F, Filtered	Used with 2 Receiver Stations Where Shifted I-F is Required.
TRD6312A	146-174		

SPECIFICATIONS

Input Impedance	50 ohms		
Number of Channels	1, 2, 3, or 4		
Frequency Separation	2.0 MHz		
I-F Frequency	10.7 MHz or 10.8 MHz		
EIA Modulation Acceptance	± 7 kHz Minimum		
Frequency Stability	± .0005% from -30°C to +60°C ambient (+ 25°C reference) ± .0002% Optional*		
Channel Spacing	20 kHz, 25/30 kHz		
Sensitivity: 20 dB Quieting EIA SINAD	Less Than Less Than	<u>With Preamp**</u> .25 uV .20 uV	<u>Without Preamp</u> .50 uV .35 uV
Selectivity: EIA SINAD	20 kHz Channel 25/30 kHz Channel	85 dB 95 dB	90 dB 100 dB
Intermodulation: EIA SINAD	20 kHz Channel 25/30 kHz Channel	75 dB (Minimum) 80 dB (Minimum)	80 dB (Minimum) 85 dB (Minimum)
Spurious and Image Rejection		100 dB (Minimum)	100 dB (Minimum)

** Available with option C621, C622, C623, C624.

** Optional Model HLD4050A RF Preamp.

1. DESCRIPTION

1.1 These receivers are fully transistorized units that receive FM signals on one to four crystal-controlled frequencies. In a multi-frequency receiver, only one frequency can be received at a time.

1.2 Each receiver includes an rf preselector, mixer, local oscillator injection circuitry, high gain selective i-f

stages, quadrature detector, audio preamplifier, and a low-ripple 9.5 volt regulator. The receiver develops a low noise audio signal from a frequency modulated "on-channel" rf carrier in the 132-174 MHz range. An optional rf preamplifier may be used with any of these receivers.

1.3 All circuits are constructed on a single plug-in circuit board which is easily accessible for servicing. The

technical writing services

1301 E. Algonquin Road, Schaumburg, IL 60196

receiver plugs into the backplane interconnect board which provides all dc, audio, and rf connections thereby eliminating all interconnecting wiring. All alignment points are accessible through the top of the rf compartment cover.

2. THEORY OF OPERATION

2.1 PI FILTER, RF PRESELECTOR, OPTIONAL PREAMPLIFIER

The receive port of the antenna switch is connected to the 5 cavity helical resonator rf preselector through the input "pi" filter. The "pi" filter, consisting of C135, C136, and L112, provides additional filtering for higher frequency spurious responses. The steep skirted rf preselector filter has a bandwidth of 2.0 MHz and ultimate rejection of 100 dB. To provide additional front-end selectivity while minimizing loss, the optional rf preamplifier is inserted in the housing between the second and third cavities. The output of the preselector (L5) is connected to the gate of N-channel JFET mixer, Q103.

2.2 LOCAL OSCILLATOR INJECTION CIRCUITRY

Plug in crystal oscillator modules (channel elements) provide a stable, temperature compensated frequency which is applied to injection amplifier Q101. Each receiver is capable of receiving up to four distinct frequencies. The output of Q101 (typical gain of 15 dB) passes through a two pole bandpass filter which attenuates unwanted harmonics of the injection frequency. The injection level of +12 dBm (typical) is coupled to the source of mixer Q103.

2.3 MIXER

Excellent intermodulation immunity is provided by a JFET mixer, Q103. The filtered receive input and injection signal are applied to the gate and source respectively. The output at the drain is applied to impedance matching circuitry which emphasizes the difference frequency applied to the i-f circuitry. Both the mixer and the following impedance matching circuitry are shielded.

2.4 I-F CIRCUITRY

2.4.1 Several stages of filtering and amplification are employed in the i-f circuitry. Selective i-f filtering is accomplished using dual-resonator, mode coupled monolithic crystals cut to a fundamental frequency of 10.7 MHz or 10.8 MHz. Due to the inherent piezoelectric properties of the crystal material, input signals selectively produce mechanical vibrations which propagate through the device. At the output the same piezoelectric property selectively converts the mechanical vibrations into the i-f electrical signal.

2.4.2 Refer to Figure 1. The high "Q" of the crystals create steep skirts which result in excellent on-channel intelligibility and off-channel signal rejection. The i-f circuitry requires no tuning and makes extensive use of shielding.

2.4.3 The first crystal filter is a single 2-pole device, Y201. This stage is followed by a matching network, 16 dB discrete amplifier Q201, additional matching, and 4-pole filter Y202-Y203. The output of the first 4-pole filter is applied to a matching network and then to high gain (approximately 50 dB) 2nd i-f amplifier U201. The output of U201 is applied to matching circuitry, a 2nd 4-pole filter Y204-Y205, final matching circuitry, and limiter/detector U202.

2.5 LIMITER/DETECTOR

Limiter/Detector U202 is a 16-pin monolithic integrated circuit that internally includes three stages of i-f amplification for limiting, a quadrature fm detector, audio preamplifier, and alignment metering output. The recovered audio output of approximately 500 mV is applied to audio buffer amplifier Q202, which provides the 250 mV receiver detected audio level required by the R1 (or R2) audio board in the control package.

2.6 9.5 VOLT REGULATOR

The regulated 9.5 volts and 13.8 volts provided to the receiver from the station power supply are applied to Q104 and Q105, resulting in a highly regulated and filtered 9.5 volts. This highly regulated 9.5 volts is supplied to the receiver channel elements, quadrature detector U202, and audio preamplifier Q202 to assure good receiver hum and noise performance.

2.7 DELAYED KEYED A +

This circuit (Q102) provides for disabling of the receiver channel element while the base station is in the transmit mode and prevents audio feed back to the receiver.

3. MAINTENANCE

Malfunctions in the receiver can be localized by using the optional built-in station metering kit or connecting a Motorola portable test set to the receiver metering receptacle and making stage measurements. The meter readings may be compared to the values shown on the receiver functional diagram, but preferably, a log of readings should be maintained for reference. Each new set of readings should then be compared to previous readings. An abrupt change in a meter reading indicates a circuit failure while a gradual change in a reading may indicate an impending failure which can be corrected before operation becomes marginal. Refer to the Receiver Maintenance section for further information.

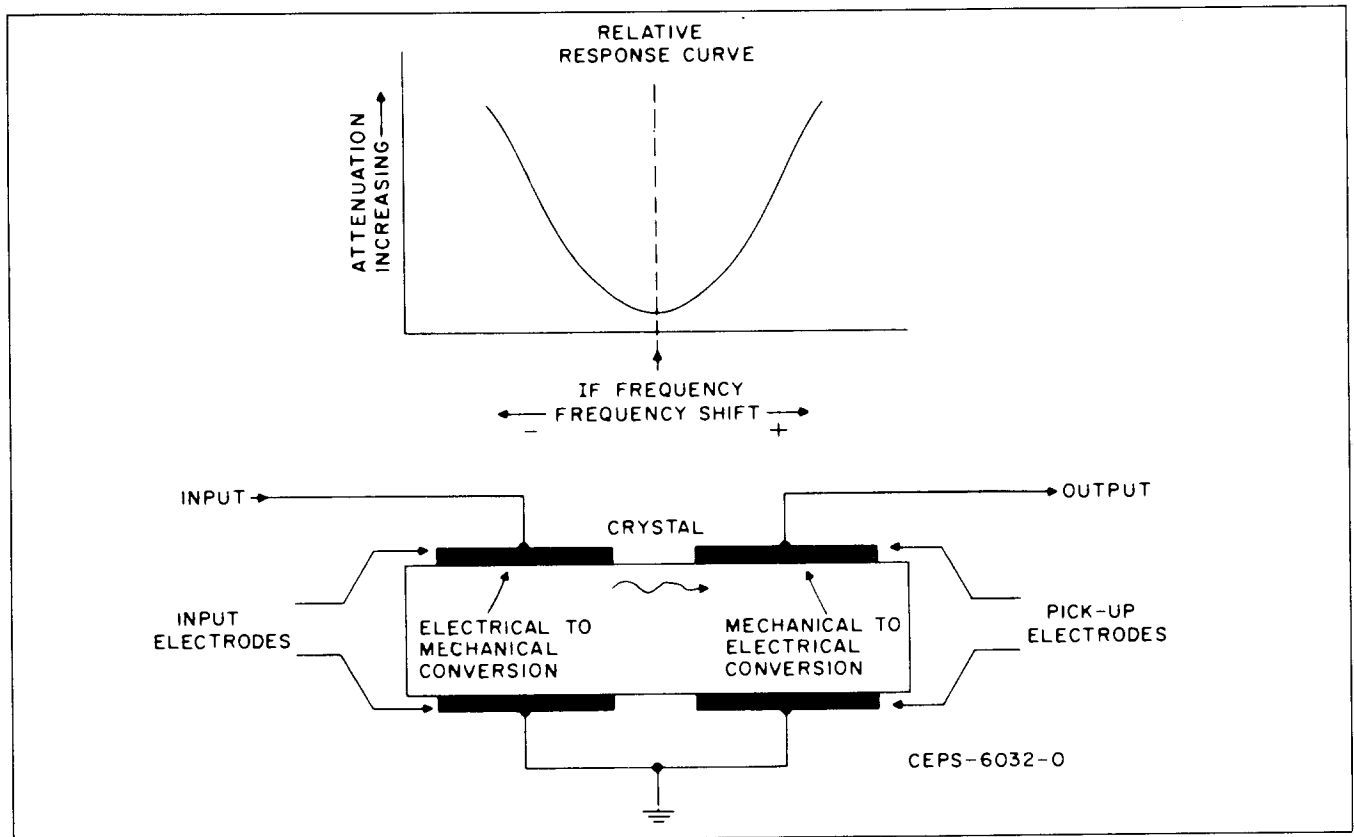

Figure 1. Simplified Piezoelectric Coupling Diagram

4. RECEIVER FUNCTIONAL TESTS

4.1 AUDIO AND SQUELCH TEST

The receiver and R1 audio board should provide 1.0 watts of audio when the VOLUME control on the R1 audio board is set fully clockwise and a strong carrier signal is received that is modulated ± 3.0 kHz deviation with a 1000 Hz tone. When the rf input signal is reduced to minimum and the SQUELCH control on the R1 audio board is set at threshold, the speaker should be quieted. Increasing the rf input signal a small amount should again produce noise in the speaker. On *Private-Line* models, no signal should be heard from the speaker unless the signal has the proper PL tone modulation. These circuits may be checked as follows:

Step 1. PL disable station. Connect speaker to test connector on mother board. Adjust the signal generator for 1000 μ V input to the receiver modulated with 1000 Hz tone for ± 3.0 kHz deviation.

Step 2. Connect an ac voltmeter to measure the voltage between pins 1 and 2 of the control metering socket.

Step 3. Set the VOLUME control on the R1 audio board fully clockwise. The ac voltmeter should indicate at least 2.8 volts rms.

Step 4. Decrease the signal generator output to minimum. Remove modulation from signal generator.

Step 5. Set the SQUELCH control at threshold, that is, clockwise until the noise just quiets.

Step 6. Increase the signal generator output slightly until the noise is again heard in the speaker. No more than .125 μ V should be required.

Step 7. On *Private-Line* radios, enable the PL function. No noise should be heard in the speaker.

Step 8. Modulate the rf signal with the proper *Private-Line* tone with ± 500 Hz deviation. Adjust signal generator output until noise is again heard in speaker. (See audio section for PL squelch specifications).

4.2 20 DB QUIETING TEST

With no signal input and the receiver unquieted, noise should be heard in the speaker or indicated on position 11 of the portable test set (function selector switch in RCVR position). When a carrier frequency signal is injected, the noise should decrease. No more than 0.5 uV (.25 uV if radio is equipped with rf preamplifier) should be required to decrease the noise 20 dB. This may be checked as follows:

Step 1. Unquiet receiver by turning the SQUELCH control on the R1 audio board fully counterclockwise. PL disable the receiver.

Step 2. Set the function selector switch on the portable test set to the RCVR position and the selector switch to position 11.

Step 3. Adjust VOLUME control on the R1 audio board for noise in the speaker and a reading on the test set meter. A reading of 1.5 V ac is a convenient reference value to use.

Step 4. Connect an rf signal generator (set to the receiver carrier frequency) to the antenna input connector.

Step 5. Beginning with minimum signal level, increase the signal generator output until the meter 11 reading drops to 1/10 the reference value in Step 3, that is 0.15 V ac. No more than 0.5 microvolt output from the signal generator should be required to quiet the receiver.

4.3 RECEIVER GAIN MEASUREMENTS

NOTE

Before making any receiver gain measurements, make sure the case of every crystal filter has a good conductive path to ground. A continuity test should indicate less than 1 ohm between the crystal filter case and the receiver circuit board ground plating. A bad ground connection may cause errors in gain measurements.

Step 1. Proper receiver alignment is essential to this procedure portion of the Station Alignment. Perform a complete receiver alignment as given in the "Receiver Alignment" section of this manual.

Step 2. Refer to the Receiver Functional Block Diagram, receiver schematic diagram, and the receiver circuit board detail diagram while performing this procedure.

Step 3. Adjust the rf signal generator output frequency to the receive channel frequency. Adjust the rf signal generator output to provide the required receiver input voltage for a particular test point. Then, using an

rf ac voltmeter, measure the rf signal voltage between the test point and a nearby chassis ground point. At every test point, the measured voltage should be within ± 6 dB of the given value.

5. TROUBLESHOOTING TECHNIQUES

5.1 VISUAL INSPECTION

The first step in the troubleshooting procedure should be a thorough visual inspection of the receiver and, in particular, the receiver board. Corrosion, burned or damaged components are usually easily seen and may be the cause or a symptom of the receiver malfunction. An improperly installed receiver shield can cause a degradation in receiver performance.

After the "obvious" problems have been corrected, repeat the receiver board performance tests. If the tests still produce unsatisfactory results, refer to the receiver troubleshooting chart in this section. The troubleshooting chart provides a systematic procedure for isolation of the defective stage and component.

As much information as possible has been included on the troubleshooting chart. However, it will be necessary to occasionally refer to the receiver schematic diagram and circuit board detail. Detailed procedures regarding alignment as a troubleshooting technique, integrated circuit troubleshooting, receiver gain measurements, and crystal troubleshooting follow in the remaining paragraphs of this section.

5.2 ALIGNMENT AS A TROUBLESHOOTING TECHNIQUE

Low meter readings, and otherwise abnormal performance of the receiver are very often corrected by realignment. Therefore, alignment should be one of the first troubleshooting steps performed for these symptoms.

5.3 TROUBLESHOOTING INTEGRATED CIRCUITS

Integrated circuits (IC) are very reliable components and should not be replaced unless it is definitely indicated that the IC is the defective component. Before replacing an IC, make sure that the external components in the circuit are normal. The IC's on the receiver board may be checked by dc voltage measurements. Refer to schematic diagram for correct voltages.

5.4 TROUBLESHOOTING CRYSTALS

A defective filter crystal can best be found by performing an i-f gain check per the schematic diagram. A defective crystal will show an abnormally high insertion loss. If the crystal is found to be defective because of high insertion loss or an ungrounded case, it should be replaced.

VHF RECEIVER

MODEL SERIES TRD6290A, TRD6300A,
AND TRD6310A

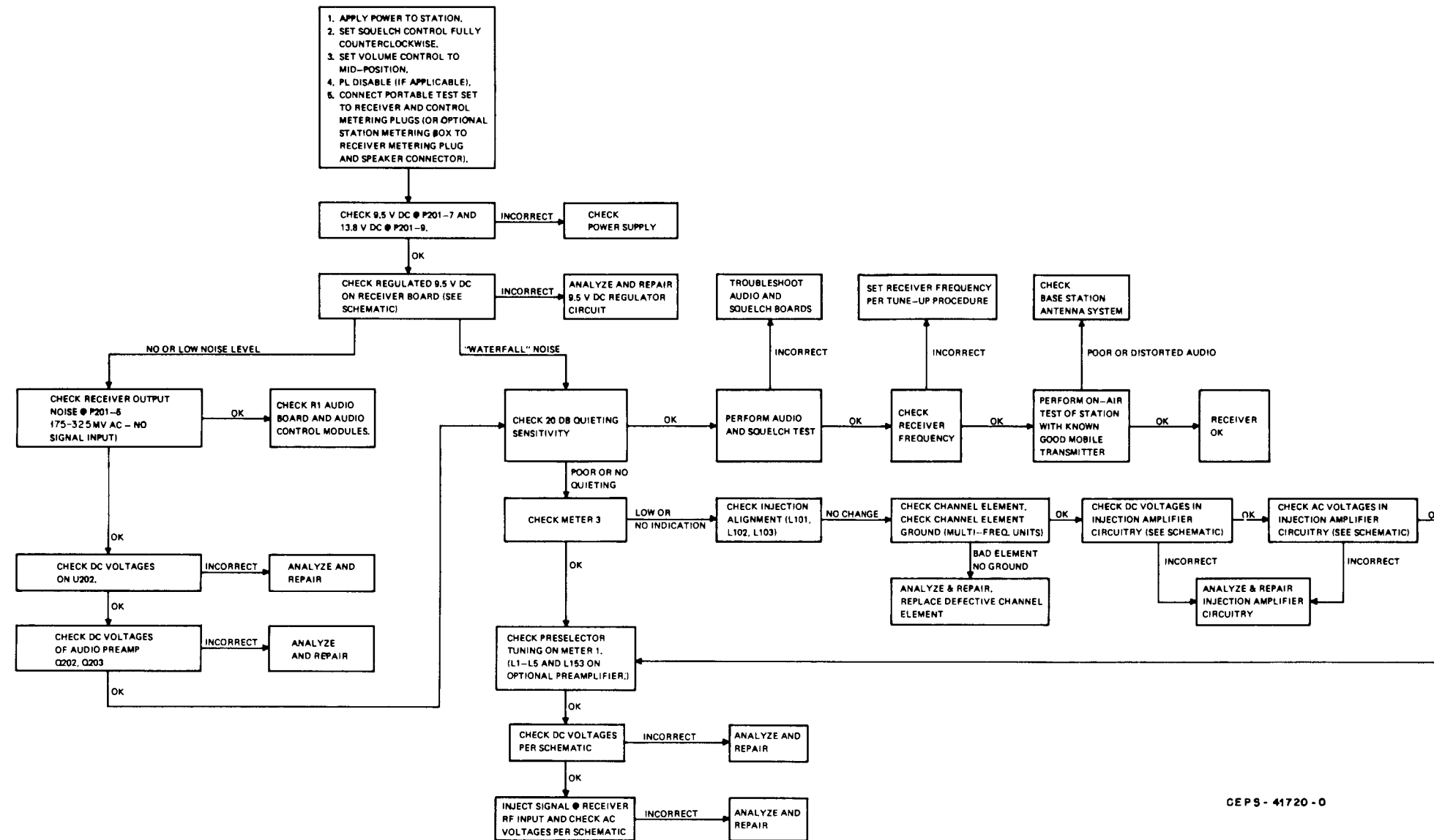

CEPS - 41720 - 0

VHF RECEIVER

MODEL SERIES TRD6290A, TRD6300A,
AND TRD6310A

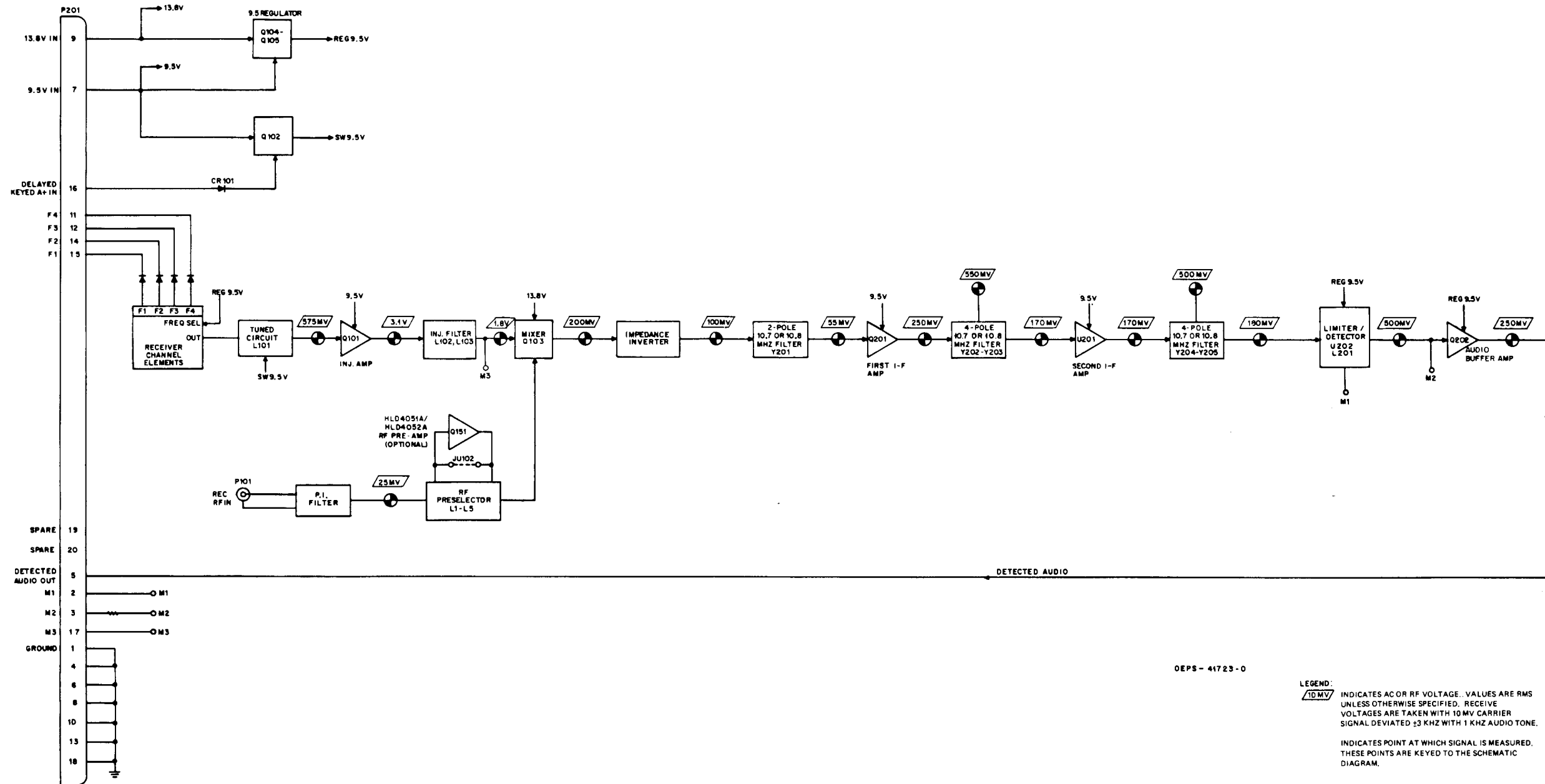

REQUIRED TEST EQUIPMENT FOR VHF RECEIVER SERVICING			
General Type	Application	Recommended Model	Minimum Specifications
AC-DC VOM	DC voltage measurements, general	Motorola T1009	Measurement range: 0-15 V dc Sensitivity: 20,000 ohms/volt
DC Multimeter	DC voltage readings requiring a high input resistance meter	Motorola S1063	Measurement range: 0-15 V dc Input resistance: 11 megohms
AC Voltmeter	Audio voltage measurements	Motorola S1053	Measurement range: 0-10 V ac Input resistance: 10 megohms
RF Voltmeter	RF voltage measurements	Motorola S1339	Measurement range: 100 uV-3 V from 1 MHz-512 MHz Inputs: 50 ohm and high impedance
Oscilloscope	Waveform observation	Motorola R1004	Vertical sensitivity: 5 mV-10 V/division Horizontal time base: 0.2 usec. 0.5 sec/division
Frequency Meter	Receiver frequency measurement	Model R1200 Service Monitor with high stability oscillator (X suffix) option. Frequency calibration recommended every 6 months or less.	Measurement range: 134-174 MHz Frequency resolution: 10 Hz
RF Signal Generator	Receiver alignment and troubleshooting	Motorola R1200 Service Monitor with attenuator	Frequency range: 134-174 MHz Output Level: 0.1 uV-100,000 uV Must be capable of at least ± 3 kHz deviation when modulated by 1 kHz tone.
Audio Signal Generator	Audio circuit troubleshooting	Motorola S1067	Frequency range: 20 Hz-20 kHz Output level: 50 mV-1 V
PL Tone Generator*	Tone-coded Private-Line decoder troubleshooting	Motorola S1333	Frequency range: 10 Hz-9999 Hz Output level: 0-3 V rms
DPL Test Set**	Digital Private-Line encoder-decoder troubleshooting	Motorola SLN6413	
Radio Test Set	Meter readings at circuit metering points for alignment and troubleshooting	Motorola S1056 Portable Test Set with a TEK-37 or TEK-37A Test Set Adapter or a Motorola TEK-5 Meter Panel with a TEK-40 (MICOR Adapter) Cable.	
DC Power Supply	DC power for shop service	Motorola R1011	1-20 V dc 0-40A

*Required for tone-coded Private-Line models only.
**Required for Digital Private-Line models only.

NOTE

All test equipment, with the exception of the DPL test set and dc power supply, may be replaced by the Motorola R2001 System Analyzer. Tuning tools Motorola Part No. 66-82977K01 and 66-83398A01 are to be used for alignment purposes.

RECEIVER FREQUENCY CALCULATIONS

Where

f_o = channel element frequency
 f_c = carrier frequency
 f_{inj} = injection frequency

10.7 MHz I-F Receivers

$$f_{inj} = f_c - 10.7 \text{ MHz}$$

$$f_o = \frac{f_c - 10.7 \text{ MHz}}{3}$$

10.8 MHz I-F Receivers

$$f_{inj} = f_c - 10.8 \text{ MHz}$$

$$f_o = \frac{f_c - 10.8 \text{ MHz}}{3}$$

VHF RECEIVER ALIGNMENT PROCEDURE

The tuning procedure should be performed using the Motorola S1056 portable Test Set. Connect metering cable to receiver metering socket on rear of interconnect board. Place the A/B switch in the A position and the FUNCTION SELECT switches to the RCVR position and meter reverse position. If using the TEK5-F or modified TEK5-B through TEK5-E meter panels, put the function switch to position C and the M1, 2 switch to the normal position. If using the optional station metering box, put the FORWARD-REVERSE switch in the FORWARD position.

NOTE

For units containing two receivers, align each receiver individually using this same procedure.

Step	Meter Position	Adjust	Procedure
1		L1-L5	Preset the rf preselector tuning screws per the coil preset chart.
2		L101, L102, L103	Preset the injection string coil slugs per the coil preset chart.
3			Perform Step 3A for radios with maximum receive frequency separation of 0.5 MHz or less; perform Steps 3B and 3C for radios with maximum receive frequency separation greater than 0.5 MHz
3A	3	L103, L102, L101	Adjust the injection string coils for peak reading on meter 3 with lowest frequency selected. Repeat until no further improvement is obtained.
3B	3	L103, L102, L101	Adjust the injection string coils for peak reading on meter 3 with highest frequency selected. Repeat until no further improvement is obtained. Tune L103 for peak meter 3 reading with lowest frequency selected. Repeat L101 and L102 for peak on highest frequency and L103 on lowest frequency until no further improvement is obtained.
3C	3	L102	If meter 3 reading on lowest frequency is less than meter 3 reading on highest frequency, increase meter 3 reading on lowest frequency by adjusting L102 for best balanced reading.
		L103	If meter 3 reading on highest frequency is less than meter 3 reading on lowest frequency, increase meter 3 reading on the highest frequency by adjusting L103 for best balanced reading. Make sure the frequency reading does not drop below the highest frequency reading.
4	1	L1-L5 (and L153 on optional preamp)	Adjust L1, L2, (L153), L3, L4, L5 in order for peak reading on meter 1 using the highest frequency and maintaining meter 1 between 30 and 40 uA by adjusting the signal generator output. Repeat until no further improvement is obtained. Perform Step 7 only for radios with maximum receive frequency separation greater than 0.5 MHz.
5	1	L1-L5 (and L153 on optional preamp)	Adjust L1, L2, (L153), L3, L4, L5 once in that order for peak reading on meter 1 using the lowest frequency and maintaining meter 1 between 30 uA and 40 uA by adjusting the signal generator output.
6	Audio zero beat (See Note)	Channel Element	For each frequency, set rf generator to the carrier frequency (± 75 Hz) without modulation. With a wire connected to a 1 mV, 10.7 MHz (or 10.8 MHz for receivers with shifted i-f frequency) signal source, "spray" the signal near Q201. Warp channel element for audio zero beat. Perform Step 7A for radios with maximum receive frequency separation of 0.5 MHz or less; perform Step 7B for radios with maximum receive frequency separation greater than 0.5 MHz
7A	AC Voltmeter across speaker	L5 (or L1 and L2 on rcvr. with optional preamp)	Adjust L5 (or L1 and L2 in Preamp Radios) for best quieting with the highest frequency selected. Receiver tuning is now complete.
7B	AC Voltmeter across speaker	L1-L5 (Do not adjust L153 on optional preamp)	Check 20 dB quieting sensitivity on all frequencies. If necessary, retune L1 and L2 once on highest frequency for best quieting. Check sensitivities again and if necessary retune L3-5 once, on the lowest frequency, for best quieting. Receiver tuning is now complete.

Note: Alternate Method of Setting Receiver Oscillator Frequency Using a Frequency Counter.

"Sniff" the injection frequency in the following manner: Connect a coax cable which has 1 to 2 inches of ground shield removed from one end to the frequency counter. Insert this end into coil form L103 in the receiver injection circuit. This should provide enough signal to accurately gate the counter. For each frequency, adjust the receiver channel element for the injection frequency ± 75 Hz. (Calculate injection frequency using appropriate formula at beginning of alignment procedure.)

RECEIVER METER READINGS

When the receiver is properly aligned, meter deflections should fall within the following limits. Where two numbers are given, the readings are non-preamp/preamp.

Switch Position	Meter 1	Meter 2	Meter 3
Meter Reading (no signal)	12/14 uA (min) 30/32 uA (max)	20 uA (min) 30 uA (max)	10 uA (min)
Function Metered	Limiter/Detector	Detector Alignment	Receiver Injection

Coil Preset Charts

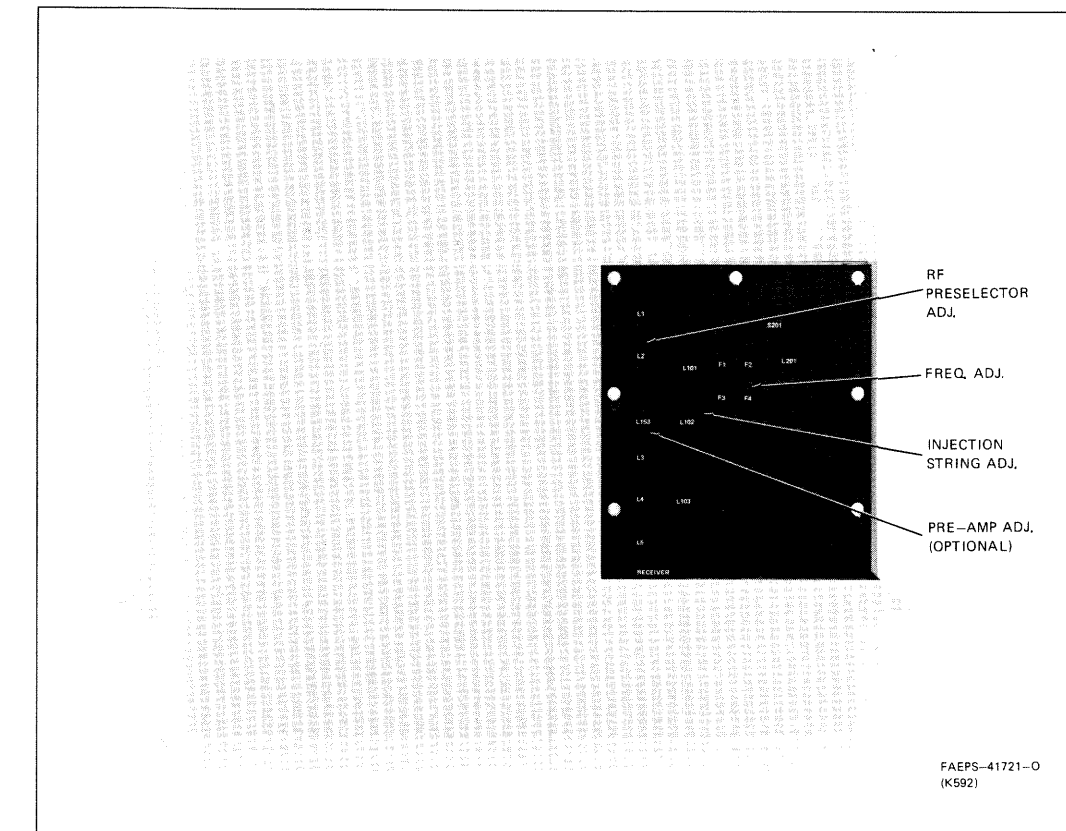
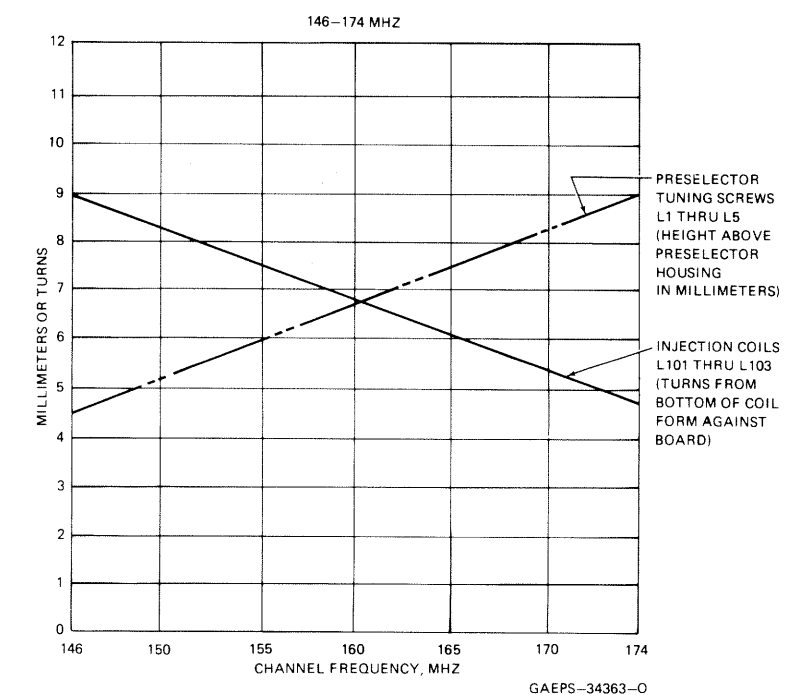
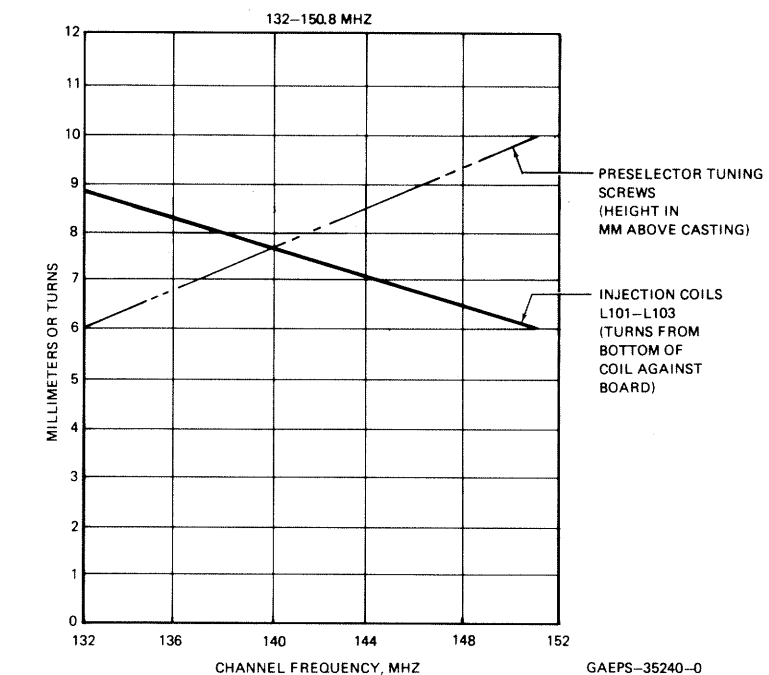

Figure 2. Receiver Alignment Adjustment Locations

VHF RECEIVER
 MODEL SERIES TRD6290A, TRD6300A,
 AND TRD6310A

parts list

TRD6291A, TRD6292A 10.7 MHz I-F Receiver, Non-Filtered
 TRD6301A, TRD6302A 10.7 MHz I-F Receiver, Filtered
 TRD6311A, TRD6312A 10.8 MHz I-F Receiver, Filtered PL-9667-C

REFERENCE SYMBOL	MOTOROLA PART NO.	DESCRIPTION
C101	21-11021H06	capacitor, fixed: pF ± 5%; 50 V; unless otherwise stated
C102L	21-82204B31	0.33 uF + 80-20%
C102H	21-82204B75	8.0 ± 0.25 pF
C103L	21-11022G12	5.6 ± 0.25 pF
C103H	21-11022G08	3 ± 0.25 pF
C104	21-11022G37	2 ± 0.25 pF
C105	21-11021H06	0.33 uF + 80-20%
C106	21-11021E05	220 ± 10%
C107	21-11021H06	0.33 uF + 80-20%
C108	21-11021E05	220 ± 10%
C109L	21-11022H29	12
C109H	21-11022H23	8.1 ± 0.5 pF; N150
C110L	21-842041	0.36
C110H	21-82450B26	0.3 ± 10%; 500 V
C111L	21-11022H29	12
C111H	21-11022H23	8.2 ± 0.5 pF; N150
C112	21-11022G12	3 ± 0.25 pF
C113	21-11021E05	220 ± 10%
C115	21-11021H06	0.33 uF + 80-20%
C116	21-11021E05	220 ± 10%
C117L	21-11014H13	3.3 ± 0.25 pF
C117H	21-11022G08	2 ± 0.25 pF
C118	21-11021H06	0.33 uF + 80-20%
C119	21-11022G50	68
C120	21-11021E05	220 pF ± 10%
C121	23-11019A21	10 uF ± 20%; 35 V
C122	21-82989E17	7 ± 0.25 pF; 500 V
C123	21-83406D84	5.6 ± 0.25 pF
C124	21-82989E21	9 ± 0.25 pF; 500 V
C125	23-11019A46	100 uF ± 20%; 25 V
C126	21-11021H06	0.33 uF + 80-20%
C127, 128	23-11019A46	100 uF ± 20%; 25 V
C129	21-11021H06	0.33 uF + 80-20%
C130 thru 133	21-11021E05	220 ± 10%
C135, 136	21-11022G34	15
C201	21-82450B07	0.39; 500 V
C202	21-11022G45	43
C203	21-11022G40	27
C204 thru 207	21-11021H06	0.33 uF + 80-20%
C208	21-11022G44	30
C209	21-11022G41	30
C213	21-82450B44	0.82; 500 V
C216	21-11022G40	27
C217	21-11022G45	43
C218 thru 222	21-11021H06	0.33 uF + 80-20%
C223	21-11014H42	51; 100 V
C224	21-11022G38	22
C225	21-11022G39	24
C226	21-82450B44	0.82; 500 V
C227	21-82450B17	2.2; 500 V
C231	21-11022G41	30
C232	21-11022G44	39
C233 thru 235	21-11021H06	0.33 uF + 80-20%
C236	21-11022G17	4.7 uF ± 0.25
C237	21-11022G25	8 uF ± 0.5
C238	21-11022G31	11 uF ± 5%
C241	21-11021H06	0.33 uF ± 5%
C242	21-11021H06	0.33 uF + 80-20%
C243	21-11021E21	.0047 uF ± 10%
C244	8-11017A08	.0047 uF ± 5%
C247	23-11019A27	22 uF ± 20%; 25 V
C248 thru 260	21-11021E13	1000 (TRD6182A, 6192A)
CR101	48-83654H01	diode: (see note)
CR102	48-82139G01	silicon
CR103 thru 110	48-83654H01	germanium
CR111	48-83654H02	silicon
J103	28-80181B01	connector, plug:
J104 thru 107	28-80096A01	male; 6-contact
L11	24-80032A07	coil, rf:
L1H	24-80032A02	helical; VIO
L2L	24-80032A08	helical; RED
L2H	24-80032A03	helical; BRN
L3L	24-80032A09	helical; GRN
L3H	24-80032A05	helical; NAT
L4L	24-80032A06	helical; BLU
L4H	24-80032A01	helical; NAT
L5L	24-80032A10	helical; BLU
L5H	24-80032A04	helical; YEL
L101, 102	24-80065A01	4-1/2 turns; coded RED
L103	24-80065A03	4-1/2 turns; coded YEL
L104, 105	24-82548D29	choke; 1.8 uH
L106	24-82723H04	choke; 0.29 uH
L107	24-83884G12	117 nH (8-1/2 turns); coded RED
L108	24-82835G11	choke; 3.5 uH
L109	24-83961B02	5 turns; coded GRN
L110	24-83397L11	choke; 30 uH
L111	24-83397L08	choke; 15 uH
L112	24-83884G08	73 nH; 5-1/2 turns; coded ORG

REFERENCE SYMBOL	MOTOROLA PART NO.	DESCRIPTION
L202	24-83397L07	choke; 10 uH
L203	24-82723H03	choke; 23 uH
L204, 205	24-83397L07	choke; 10 uH
L206	24-82723H03	choke; 23 uH
L207	24-83397L08	choke; 15 uH
L208	24-83397L07	choke; 10 uH
L209	24-82723H03	choke; 23 uH
L210 thru 222	24-83961B01	choke; 3 turns (BRN) (TRN6181A, TRD6182A, TRN6191A, TRD6192A)
	or 6-11009B23	resistor jumper (TRN6171A, TRD6172A)
L230	24-11047B58	or 10
L231	24-83397L07	choke; 24 uH
	24-83397L07	choke; 10 uH
P101	9-82872N01	connector, receptacle:
P200, P201	9-83497F05	female; 10-contact (2 ea.)
Q101	48-869932	transistor: (see note)
Q102	48-869643	NPN; type M9932
Q103	48-869639	PNP; type M9643
Q104	48-869642	field-effect; type M9839
Q105	48-84411L10	NPN; type M1110
Q201	48-869494	NPN; type M9494
Q202	48-869643	PNP; type M9643
R102	6-11009A13	resistor, fixed: ± 5%; 1/4 W; unless otherwise stated
R103	6-11009A57	33
R104	6-11009A45	2.2k
R105	6-11009A24	680
R106	6-11009A71	91
R107	6-11009A73	8.2k
R108	6-11009A39	10k
R109	6-11009A51	390
R110	6-11009A25	3.3k
R111	6-11009A81	15
R112, 113	6-11009A49	100
R201	6-11009A79	22k
R202	6-11009A49	1k
R203	6-11009A87	18k
R204	6-11009A37	39k
R205	6-11009A11	330
R206	6-11009A54	27
R207	6-11009A93	1.6k
R208	6-11009A35	68k
R209, 210	6-11009A93	270
R211	6-11009A39	68k
R212	6-11009A41	270
R213	6-11009A41	470
R214	6-11009A49	1k
R215	6-11009A77	15k
R216	6-11009A73	10k
R217	6-11009A65	4.7k
R219	6-11009A94	75k
R220	6-11009A73	10k
R221	6-11009B02	150k
R222	6-11009A65	4.7k
U201	51-83629M05	integrated circuit: (see note)
U202	51-83629M60	second i-f amplifier
	51-83629M60	quad detector
	51-84561L84	or quad detector
Y201	91-80011E04	crystal: (see note)
	91-80011E05	10.7 MHz (TRD6301A, TRD6302A, TRN6291A, TRD6292A)
	91-80011E05	10.8 MHz (TRD6311A, TRD6312A)
Y202 thru 206	91-80011E05	10.7 MHz (TRD6301A, TRD6302A, TRN6291A, TRD6292A)
	91-80011E05	10.8 MHz (TRD6311A, TRD6312A)
	24-80045A01	mechanical parts
	24-80045A01	NUT, retainer: M5 x 0.8; 5 used

REFERENCE SYMBOL	MOTOROLA PART NO.	DESCRIPTION
3-3375		SCREW, tapping; 6-20 x 5/16"; 14 used
3-80012A04		SCREW, set; 5 used
3-84256M01		SCREW, tapping; 8 used
5-84220B01		GROMMET, panel; 8 used
15-80008A01		HOUSING
26-80062C01		SHIELD, IC
26-80121A01		SHIELD, can; 5 used
26-80144B03		SHIELD, mixer
26-80196A01		SHIELD, coil; 3 used
26-82868N01		SHIELD, 1st i-f
26-82870N01		SHIELD, input
26-84173N01		SHIELD, mag.
26-82871N01		SHIELD, quad
26-83347N01		SHIELD, 2nd i-f
26-83596M01		SHIELD, antenna
26-84243B03		SHIELD, mixer
45-83824N01		CARD, ejector; 2 used
75-05295B01		INSULATOR, xtal; 6 used

note: For optimum performance, diodes, transistors, and integrated circuits must be ordered by Motorola part numbers.

LEGEND
 L = 132-150.8 MHz (HLD4051A)
 H = 146-174 MHz (HLD4052A)

HLD4051A and HLD4052A Preampifier Boards PL-6036-E

REFERENCE SYMBOL	MOTOROLA PART NO.	DESCRIPTION
C151, 152, 153	21-83596E10	capacitor, fixed:
C154H	21-83406D52	220 pF ± 20%; 500 V
C154L	21-80067A01	2 pF ± 25 pF; 500 V
C155	21-83596E10	1.5 pF ± 25 pF; 500 V
C156H		220 uF ± 20%; 500 V
C156L	21-83406D52	not used
		2 pF ± 25 pF; 500 V
P112	9-80180B01	connector, receptacle:
		female; 6 contacts
L151, 152	24-82549A48	coil:
L153	24-80031A02	choke; 2.2 uH
		5-1/2 turns (coded gm)
Q151	48-869839	transistor: (see note)
		field-effect; type M9839
R151	6-124A25	resistor, fixed:
R152	6-124A77	100 ± 5%; 1/4 W
		15k

RECEIVER CIRCUIT BOARD DETAIL

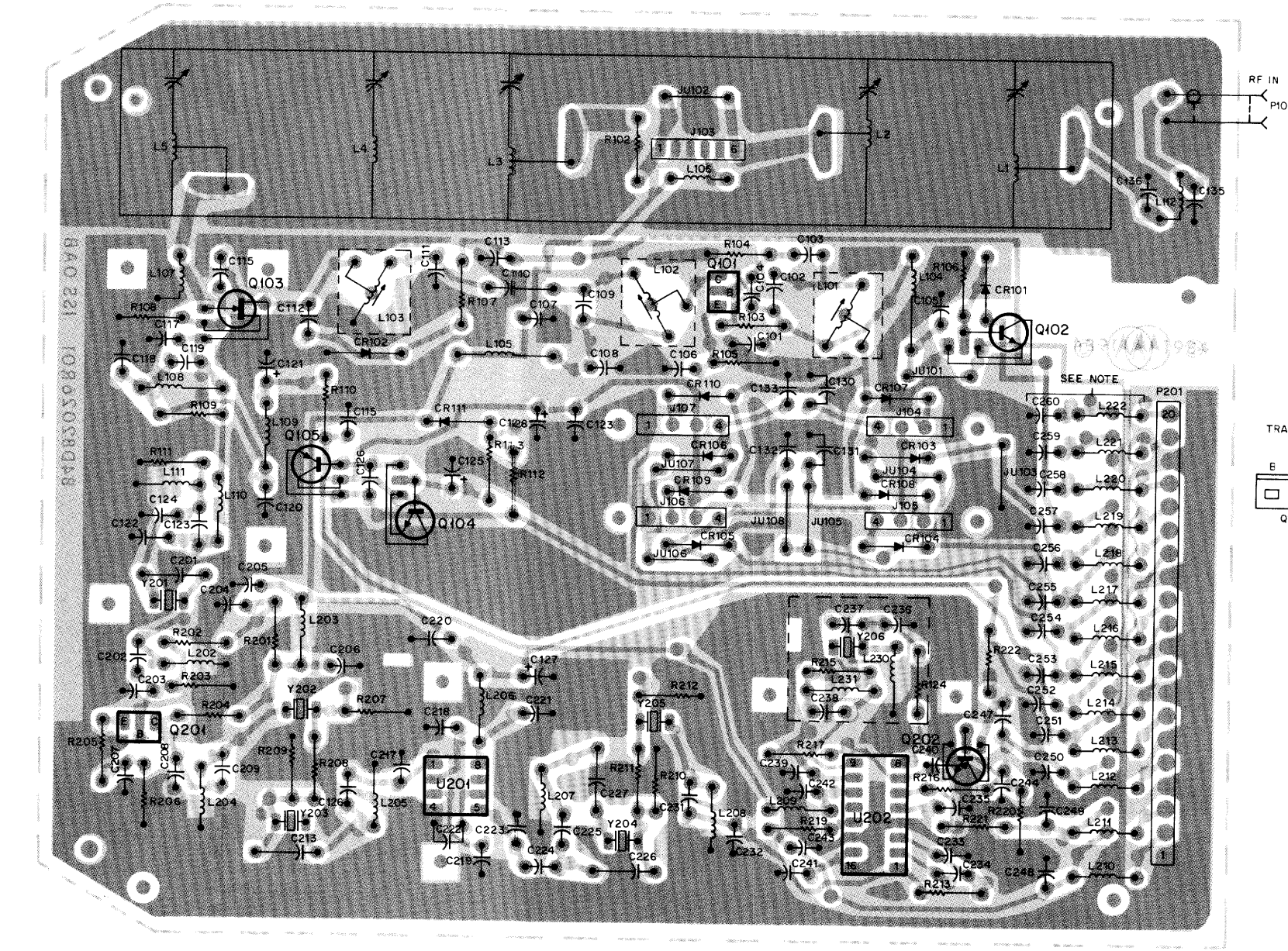

COMPONENT SIDE: BD-CEPS-41693-0
 SOLDER SIDE: BD-CEPS-41694-0 SHOWN FROM COMPONENT SIDE
 DL-CEPS-41695-0

RF PREAMPLIFIER

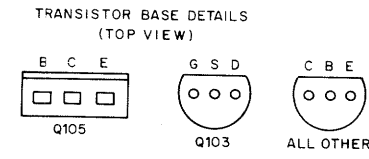
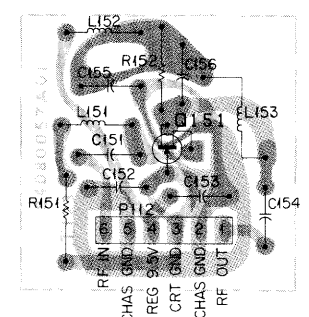

NOTE:
 C248 THRU C260 ARE DELETED
 AND Q10 THRU Q22 ARE REPLACED
 WITH JUMPERS FOR MODEL TRD6292A
 RECEIVER ONLY.

SHOWN FROM SOLDER SIDE

MODEL	FREQUENCY (MHZ)
TRD6291A	132-150.8
TRD6301A	
TRD6311A	
TRD6292A	146-174
TRD6302A	
TRD6312A	

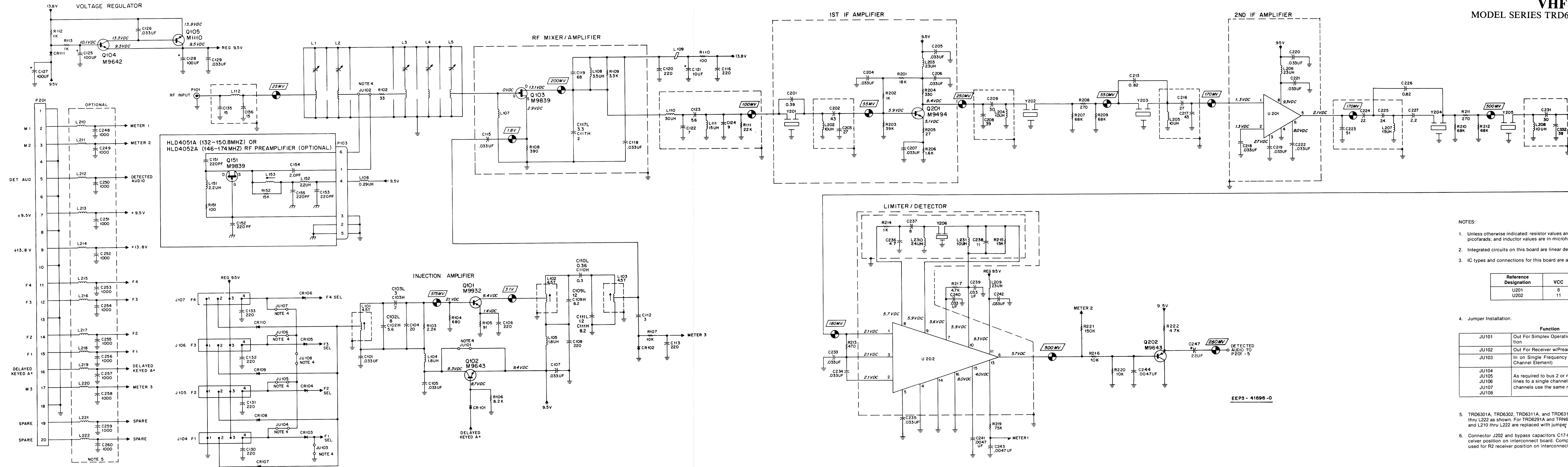
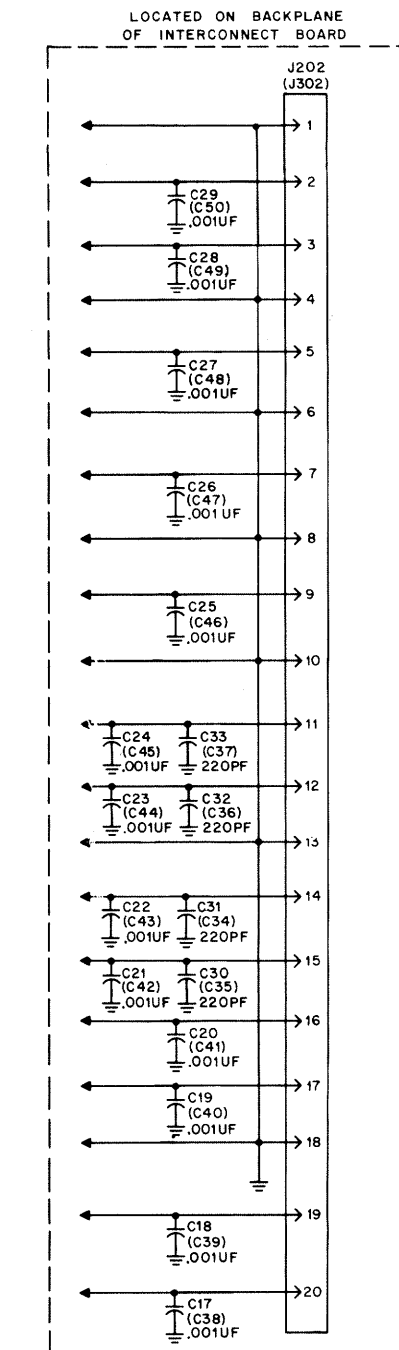

VHF RECEIVER

MODEL SERIES TRD6290A, TRD6300A, AND TRD6310A

- NOTES:
- Unless otherwise indicated: resistor values are in ohms; capacitor values are in picofarads; and inductor values are in microhenries.
 - Integrated circuits on this board are linear devices.
 - IC types and connections for this board are as follows:

Reference Designation	VCC	Gnd
U201	8	4
U202	11	4, 14

4. Jumper Installation.

Jumper	Function
JU101	Out For Simplex Operation; In For RPTR Operation
JU102	Out For Receiver w/Preamp
JU103	In on Single Frequency Radios (To Enable F1 Channel Element)
JU104	As required to bus 2 or more channel select lines to a single channel element when these channels use the same receiver frequency.
JU105	
JU106	
JU107	

- TRD6301A, TRD6302, TRD6311A, and TRD6312A use C248 thru C260 and L210 thru L222 as shown. For TRD6291A and TRD6292A, C248 thru C260 are deleted and L210 thru L222 are replaced with jumper wires.
- Connector J202 and bypass capacitors C17-C29 and C30-C33 used for R1 receiver position on interconnect board. Component designators shown in () used for R2 receiver position on interconnect board.

VHF RECEIVER



Receiver Model Table

Model	Frequency (MHz)	Description	Application
TRD6171A	132-150.8	Multi-Frequency 10.7 MHz I-F, Non-Filtered	Used with Single Receiver Stations.
TRD6172A	146-174		
TRD6181A	132-150.8	Multi-Frequency 10.7 MHz I-F, Filtered	Used with 2-Receiver Stations and Repeater Stations.
TRD6182A	146-174		
TRD6191A	132-150.8	Multi-Frequency 10.8 MHz I-F, Filtered	Used with 2 Receiver Stations where shifted I-F is required.
TRD6192A	146-174		

SPECIFICATIONS

Input Impedance	50 ohms		
Number of Channels	1, 2, 3, or 4		
Frequency Separation	2.0 MHz		
I-F Frequency	10.7 MHz or 10.8 MHz		
EIA Modulation Acceptance	± 7 kHz Minimum		
Frequency Stability	± .0005% from -30°C to +60°C ambient (+25°C reference) ± .0002% Optional*		
Channel Spacing	20 kHz, 25/30 kHz		
Sensitivity: 20 dB Quieting EIA SINAD	Less Than Less Than	With Preamp** .25 uV .20 uV	Without Preamp .50 uV .35 uV
Selectivity: EIA SINAD	20 kHz Channel 25/30 kHz Channel	85 dB 95 dB	90 dB 100 dB
Intermodulation: EIA SINAD	20 kHz Channel 25/30 kHz Channel	75 dB (Minimum) 80 dB (Minimum)	80 dB (Minimum) 85 dB (Minimum)
Spurious and Image Rejection		100 dB (Minimum)	100 dB (Minimum)

* Available with option C621, C622, C623, C624.

** Optional Model HLD4050A RF Preamp.

1. DESCRIPTION

1.1 These receivers are fully transistorized units that receive FM signals on one to four crystal-controlled frequencies. In a multi-frequency receiver, only one frequency can be received at a time.

1.2 Each receiver includes an rf preselector, mixer, local oscillator injection circuitry, high gain selective i-f

stages, quadrature detector, audio preamplifier, and a low-ripple 9.5 volt regulator. The receiver develops a low noise audio signal from a frequency modulated "on-channel" rf carrier in the 132-174 MHz range. An optional rf preamplifier may be used with any of these receivers.

1.3 All circuits are constructed on a single plug-in circuit board which is easily accessible for servicing. The

technical writing services

receiver plugs into the backplane interconnect board which provides all dc, audio, and rf connections thereby eliminating all interconnecting wiring. All alignment points are accessible through the top of the rf compartment cover.

2. THEORY OF OPERATION

2.1 PI FILTER, RF PRESELECTOR, OPTIONAL PREAMPLIFIER

The receive port of the antenna switch is connected to the 5 cavity helical resonator rf preselector through the input "pi" filter. The "pi" filter, consisting of C135, C136, and L112, provides additional filtering for higher frequency spurious responses. The steep skirted rf preselector filter has a bandwidth of 2.0 MHz and ultimate rejection of 100 dB. To provide additional front-end selectivity while minimizing loss, the optional rf preamplifier is inserted in the housing between the second and third cavities. The output of the preselector (L5) is connected to the gate of N-channel JFET mixer, Q103.

2.2 LOCAL OSCILLATOR INJECTION CIRCUITRY

Plug in crystal oscillator modules (channel elements) provide a stable, temperature compensated frequency which is applied to injection amplifier Q101. Each receiver is capable of receiving up to four distinct frequencies. The output of Q101 (typical gain of 15 dB) passes through a two pole bandpass filter which attenuates unwanted harmonics of the injection frequency. The injection level of +12 dBm (typical) is coupled to the source of mixer Q103.

2.3 MIXER

Excellent intermodulation immunity is provided by a JFET mixer, Q103. The filtered receive input and injection signal are applied to the gate and source respectively. The output at the drain is applied to impedance matching circuitry which emphasizes the difference frequency applied to the i-f circuitry. Both the mixer and the following impedance matching circuitry are shielded.

2.4 I-F CIRCUITRY

2.4.1 Several stages of filtering and amplification are employed in the i-f circuitry. Selective i-f filtering is accomplished using dual-resonator, mode coupled monolithic crystals cut to a fundamental frequency of 10.7 MHz or 10.8 MHz. Due to the inherent piezoelectric properties of the crystal material, input signals selectively produce mechanical vibrations which propagate through the device. At the output the same piezoelectric property selectively converts the mechanical vibrations into the i-f electrical signal.

2.4.2 Refer to Figure 1. The high "Q" of the crystals create steep skirts which result in excellent on-channel intelligibility and off-channel signal rejection. The i-f circuitry requires no tuning and makes extensive use of shielding.

2.4.3 The first crystal filter is a single 2-pole device, Y201. This stage is followed by a matching network, 16 dB discrete amplifier Q201, additional matching, and 4-pole filter Y202-Y203. The output of the first 4-pole filter is applied to a matching network and then to high gain (approximately 50 dB) 2nd i-f amplifier U201. The output of U201 is applied to matching circuitry, a 2nd 4-pole filter Y204-Y205, final matching circuitry, and limiter/detector U202.

2.5 LIMITER/DETECTOR

Limiter/Detector U202 is a 16-pin monolithic integrated circuit that internally includes three stages of i-f amplification for limiting, a quadrature fm detector, audio preamplifier, and alignment metering output. The recovered audio output of approximately 80 mV is applied to discrete audio preamplifier Q202-Q203, which provides the 250 mV receiver detected audio level required by the R1 (or R2) audio board in the control package. Adjustment of the quadrature detector is provided by L201.

2.6 9.5 VOLT REGULATOR

The regulated 9.5 volts and 13.8 volts provided to the receiver from the station power supply are applied to Q104 and Q105, resulting in a highly regulated and filtered 9.5 volts. This highly regulated 9.5 volts is supplied to the receiver channel elements, quadrature detector U202, and audio preamplifier Q202 to assure good receiver hum and noise performance.

2.7 DELAYED KEYED A +

This circuit (Q102) provides for disabling of the receiver channel element while the base station is in the transmit mode and prevents audio feed back to the receiver.

3. MAINTENANCE

Malfunctions in the receiver can be localized by using the optional built-in station metering kit or connecting a Motorola portable test set to the receiver metering receptacle and making stage measurements. The meter readings may be compared to the values shown on the receiver functional diagram, but preferably, a log of readings should be maintained for reference. Each new set of readings should then be compared to previous readings. An abrupt change in a meter reading indicates a circuit failure while a gradual change in a reading may indicate an impending failure which can be corrected before operation becomes marginal. Refer to the Receiver Maintenance section for further information.

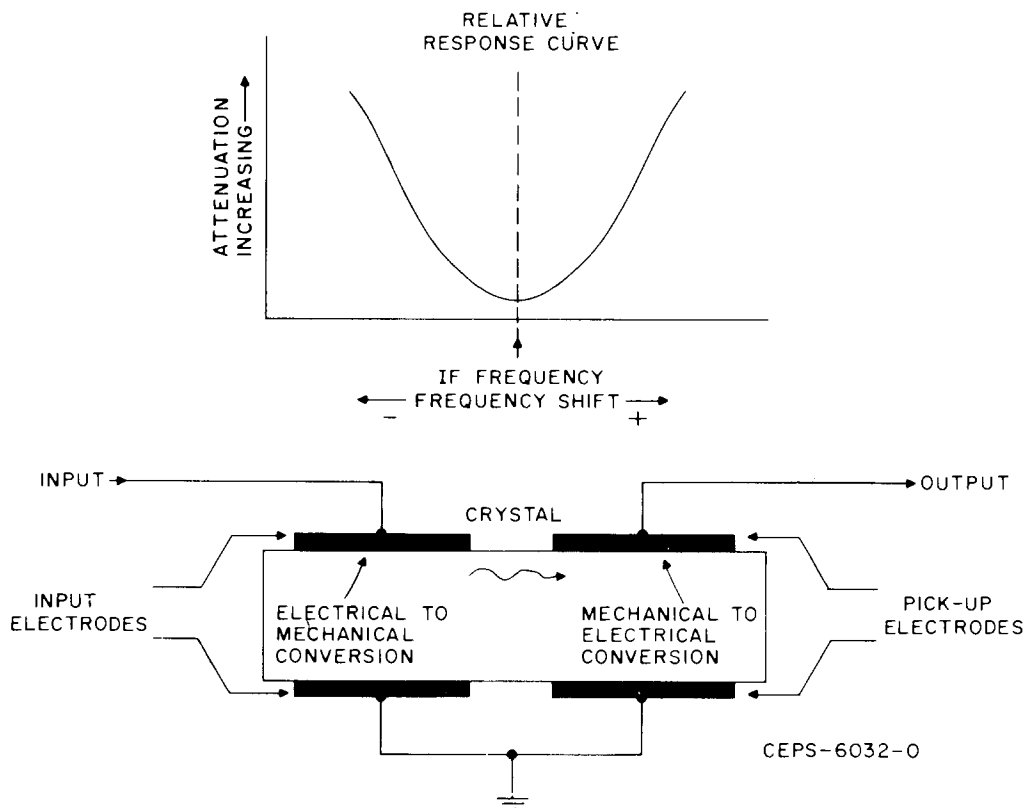

Figure 1. Simplified Piezoelectric Coupling Diagram

4. RECEIVER FUNCTIONAL TESTS

4.1 AUDIO AND SQUELCH TEST

The receiver and R1 audio board should provide 1.0 watts of audio when the VOLUME control on the R1 audio board is set fully clockwise and a strong carrier signal is received that is modulated ± 3.0 kHz deviation with a 1000 Hz tone. When the rf input signal is reduced to minimum and the SQUELCH control on the R1 audio board is set at threshold, the speaker should be quieted. Increasing the rf input signal a small amount should again produce noise in the speaker. On *Private-Line* models, no signal should be heard from the speaker unless the signal has the proper PL tone modulation. These circuits may be checked as follows:

Step 1. PL disable station. Connect speaker to test connector on mother board. Adjust the signal generator for 1000 μ V input to the receiver modulated with 1000 Hz tone for ± 3.0 kHz deviation.

Step 2. Connect an ac voltmeter to measure the voltage between pins 1 and 2 of the control metering socket.

Step 3. Set the VOLUME control on the R1 audio board fully clockwise. The ac voltmeter should indicate at least 2.8 volts rms.

Step 4. Decrease the signal generator output to minimum. Remove modulation from signal generator.

Step 5. Set the SQUELCH control at threshold, that is, clockwise until the noise just quiets.

Step 6. Increase the signal generator output slightly until the noise is again heard in the speaker. No more than .125 μ V should be required.

Step 7. On *Private-Line* radios, enable the PL function. No noise should be heard in the speaker.

Step 8. Modulate the rf signal with the proper *Private-Line* tone with ± 500 Hz deviation. Adjust signal generator output until noise is again heard in speaker. (See audio section for PL squelch specifications).

4.2 20 DB QUIETING TEST

With no signal input and the receiver unquieted, noise should be heard in the speaker or indicated on position 11 of the portable test set (function selector switch in RCVR position). When a carrier frequency signal is injected, the noise should decrease. No more than 0.5 μ V (.25 μ V if radio is equipped with rf preamplifier) should be required to decrease the noise 20 dB. This may be checked as follows:

Step 1. Unquiet receiver by turning the SQUELCH control on the R1 audio board fully counterclockwise. PL disable the receiver.

Step 2. Set the function selector switch on the portable test set to the RCVR position and the selector switch to position 11.

Step 3. Adjust VOLUME control on the R1 audio board for noise in the speaker and a reading on the test set meter. A reading of 1.5 V ac is a convenient reference value to use.

Step 4. Connect an rf signal generator (set to the receiver carrier frequency) to the antenna input connector.

Step 5. Beginning with minimum signal level, increase the signal generator output until the meter 11 reading drops to 1/10 the reference value in Step 3, that is 0.15 V ac. No more than 0.5 microvolt output from the signal generator should be required to quiet the receiver.

4.3 RECEIVER GAIN MEASUREMENTS

NOTE

Before making any receiver gain measurements, make sure the case of every crystal filter has a good conductive path to ground. A continuity test should indicate less than 1 ohm between the crystal filter case and the receiver circuit board ground plating. A bad ground connection may cause errors in gain measurements.

Step 1. Proper receiver alignment is essential to this procedure portion of the Station Alignment. Perform a complete receiver alignment as given in the "Receiver Alignment" section of this manual.

Step 2. Refer to the Receiver Functional Block Diagram, receiver schematic diagram, and the receiver circuit board detail diagram while performing this procedure.

Step 3. Adjust the rf signal generator output frequency to the receive channel frequency. Adjust the rf signal generator output to provide the required receiver input voltage for a particular test point. Then, using an

rf ac voltmeter, measure the rf signal voltage between the test point and a nearby chassis ground point. At every test point, the measured voltage should be within ± 6 dB of the given value.

5. TROUBLESHOOTING TECHNIQUES

5.1 VISUAL INSPECTION

The first step in the troubleshooting procedure should be a thorough visual inspection of the receiver and, in particular, the receiver board. Corrosion, burned or damaged components are usually easily seen and may be the cause or a symptom of the receiver malfunction. An improperly installed receiver shield can cause a degradation in receiver performance.

After the "obvious" problems have been corrected, repeat the receiver board performance tests. If the tests still produce unsatisfactory results, refer to the receiver troubleshooting chart in this section. The troubleshooting chart provides a systematic procedure for isolation of the defective stage and component.

As much information as possible has been included on the troubleshooting chart. However, it will be necessary to occasionally refer to the receiver schematic diagram and circuit board detail. Detailed procedures regarding alignment as a troubleshooting technique, integrated circuit troubleshooting, receiver gain measurements, and crystal troubleshooting follow in the remaining paragraphs of this section.

5.2 ALIGNMENT AS A TROUBLESHOOTING TECHNIQUE

Low meter readings, and otherwise abnormal performance of the receiver are very often corrected by realignment. Therefore, alignment should be one of the first troubleshooting steps performed for these symptoms.

5.3 TROUBLESHOOTING INTEGRATED CIRCUITS

Integrated circuits (IC) are very reliable components and should not be replaced unless it is definitely indicated that the IC is the defective component. Before replacing an IC, make sure that the external components in the circuit are normal. The IC's on the receiver board may be checked by dc voltage measurements. Refer to schematic diagram for correct voltages.

5.4 TROUBLESHOOTING CRYSTALS

A defective filter crystal can best be found by performing an i-f gain check per the schematic diagram. A defective crystal will show an abnormally high insertion loss. If the crystal is found to be defective because of high insertion loss or an ungrounded case, it should be replaced.

RECEIVER TROUBLESHOOTING CHART

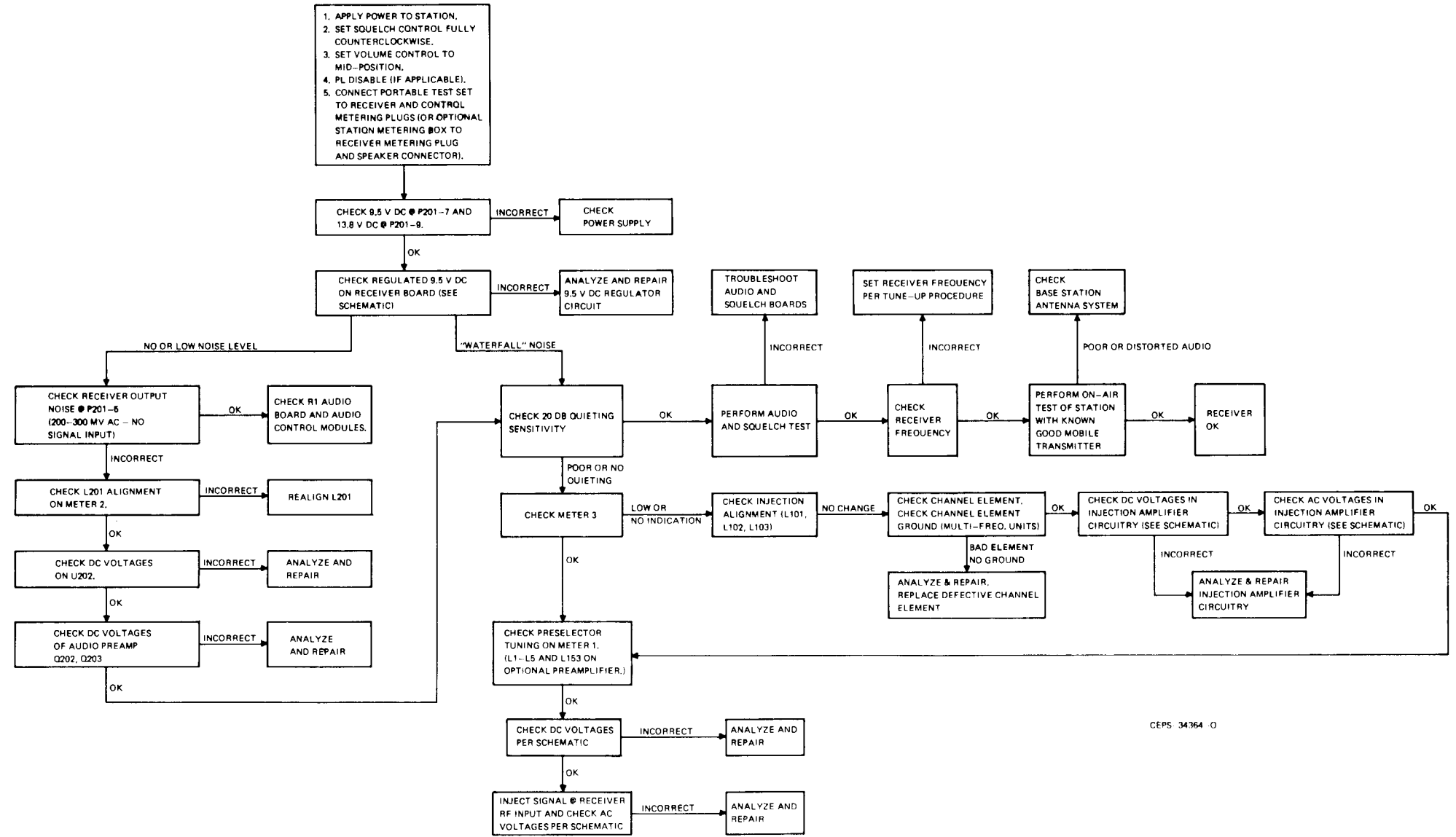

CEPS 34364 - 0

RECEIVER ALIGNMENT

MODEL SERIES TRD6170A, TRD6180A, TRD6190A

REQUIRED TEST EQUIPMENT FOR VHF RECEIVER SERVICING

General Type	Application	Recommended Model	Minimum Specifications
AC-DC VOM	DC voltage measurements, general	Motorola T1009	Measurement range: 0-15 V dc Sensitivity: 20,000 ohms/volt
DC Multimeter	DC voltage readings requiring a high input resistance meter	Motorola S1063	Measurement range: 0-15 V dc Input resistance: 11 megohms
AC Voltmeter	Audio voltage measurements	Motorola S1053	Measurement range: 0-10 V ac Input resistance: 10 megohms
RF Voltmeter	RF voltage measurements	Motorola S1339	Measurement range: 100 uV-3 V from 1 MHz-512 MHz Inputs: 50 ohm and high impedance
Oscilloscope	Waveform observation	Motorola R1004	Vertical sensitivity: 5 mV-10 V/division Horizontal time base: 0.2 usec. 0.5 sec/division
Frequency Meter	Receiver frequency measurement	Model R2400 Service Monitor with high stability oscillator (X suffix) option. Frequency calibration recommended every 6 months or less.	Measurement range: 134-174 MHz Frequency resolution: 10 Hz
RF Signal Generator	Receiver alignment and troubleshooting	Motorola R2400 Service Monitor with attenuator	Frequency range: 134-174 MHz Output Level: 0.1 uV-100,000 uV Must be capable of at least ± 3 kHz deviation when modulated by 1 kHz tone.
Audio Signal Generator	Audio circuit troubleshooting	Motorola R1150	Frequency range: 20 Hz-20 kHz Output level: 50 mV-1 V
PL Tone Generator*	Tone-coded Private-Line decoder troubleshooting	Motorola R1150	Frequency range: 10 Hz-9999 Hz Output level: 0-3 V rms
DPL Test Set**	Digital Private-Line encoder-decoder troubleshooting	Motorola R2410A Service Monitor w/ DPL Encode	
Radio Test Set	Meter readings at circuit metering points for alignment and troubleshooting	Motorola R1033 Portable Test Set with a RTK-4043A Meter Cable or a RTL-4130A Adapter with a TEK-40 (MICOR Adapter) Cable.	
DC Power Supply	DC power for shop service	Motorola R1011	1-20 V dc 0-40A

*Required for tone-coded Private-Line models only.
**Required for Digital Private-Line models only.

NOTE

All test equipment, with the exception of the DPL test set and dc power supply, may be replaced by the Motorola R2001 System Analyzer. Tuning tools Motorola Part No. 66-82977K01 and 66-83398A01 are to be used for alignment purposes.

RECEIVER FREQUENCY CALCULATIONS

Where

f_o = channel element frequency
 f_c = carrier frequency
 f_{inj} = injection frequency

10.7 MHz I-F Receivers

$$f_{inj} = f_c - 10.7 \text{ MHz}$$

$$f_o = \frac{f_c - 10.7 \text{ MHz}}{3}$$

10.8 MHz I-F Receivers

$$f_{inj} = f_c - 10.8 \text{ MHz}$$

$$f_o = \frac{f_c - 10.8 \text{ MHz}}{3}$$

VHF RECEIVER ALIGNMENT PROCEDURE

The tuning procedure should be performed using the Motorola S1056 portable Test Set. Connect metering cable to receiver metering socket on rear of interconnect board. Place the A/B switch in the A position and the FUNCTION SELECT switches to the RCVR position and meter reverse position. If using the TEK5-F or modified TEK5-B through TEK5-E meter panels, put the function switch to position C and the M1, 2 switch to the normal position. If using the optional station metering box, put the FORWARD-REVERSE switch in the FORWARD position.

NOTE

For units containing two receivers, align each receiver individually using this same procedure.

Step	Meter Position	Adjust	Procedure
1		L1-L5	Preset the rf preselector tuning screws per the coil preset chart.
2		L101, L102, L103	Preset the injection string coil slugs per the coil preset chart.
3	2	L201	Starting with the slug flush with top of coil form, adjust the detector coil for the first reading of 24 uA on meter 2 (no input signal is necessary). After adjusting the detector coil, depress S201 (using a non-metallic alignment tool) while observing meter 2 reading. Release S201.
4	2	L201	Quiet the radio by injecting a strong on-channel signal at the base station antenna connector or by setting a signal generator exactly on 10.7 MHz (or 10.8 MHz for receivers with shifted i-f frequency) and spraying into the i-f. Adjust the quadrature detector coil, L201, to obtain the same M2 reading as in Step 3. Perform Step 5A for radios with maximum receive frequency separation of 0.5 MHz or less; perform Steps 5B and 5C for radios with maximum receive frequency separation greater than 0.5 MHz.
5A	3	L103, L102, L101	Adjust the injection string coils for peak reading on meter 3 with lowest frequency selected. Repeat until no further improvement is obtained.
5B	3	L103, L102, L101	Adjust the injection string coils for peak reading on meter 3 with highest frequency selected. Repeat until no further improvement is obtained. Tune L103 for peak meter 3 reading with lowest frequency selected. Repeat L101 and L102 for peak on highest frequency and L103 on lowest frequency until no further improvement is obtained.
5C	3	L102	If meter 3 reading on lowest frequency is less than meter 3 reading on highest frequency, increase meter 3 reading on lowest frequency by adjusting L102 for best balanced reading.
		L103	If meter 3 reading on highest frequency is less than meter 3 reading on lowest frequency, increase meter 3 reading on the highest frequency by adjusting L103 for best balanced reading. Make sure the frequency reading does not drop below the highest frequency reading.
6	1	L1-L5 (and L153 on optional preamp)	Adjust L1, L2, (L153), L3, L4, L5 in order for peak reading on meter 1 using the highest frequency and maintaining meter 1 between 30 and 40 uA by adjusting the signal generator output. Repeat until no further improvement is obtained. Perform Step 7 only for radios with maximum receive frequency separation greater than 0.5 MHz.
9	1	L1-L5 (and L153 on optional preamp)	Adjust L1, L2, (L153), L3, L4, L5 once in that order for peak reading on meter 1 using the lowest frequency and maintaining meter 1 between 30 uA and 40 uA by adjusting the signal generator output.
8	Audio zero beat (See Note)	Channel Element	For each frequency, set rf generator to the carrier frequency (± 75 Hz) without modulation. With a wire connected to a 1 mV, 10.7 MHz (or 10.8 MHz for receivers with shifted i-f frequency) signal source, "spray" the signal near Q201. Warp channel element for audio zero beat. Perform Step 9A for radios with maximum receive frequency separation of 0.5 MHz or less; perform Step 9B for radios with maximum receive frequency separation greater than 0.5 MHz.
9A	AC Voltmeter across speaker	L5 (or L1 and L2 on rcvr. with optional preamp)	Adjust L5 (or L1 and L2 in Preamp Radios) for best quieting with the highest frequency selected. Receiver tuning is now complete.
9B	AC Voltmeter across speaker	L1-L5 (Do not adjust L153 on optional preamp)	Check 20 dB quieting sensitivity on all frequencies. If necessary, retune L1 and L2 once on highest frequency for best quieting. Check sensitivities again and if necessary retune L3-5 once, on the lowest frequency, for best quieting. Receiver tuning is now complete.

Note: Alternate Method of Setting Receiver Oscillator Frequency Using a Frequency Counter.

"Sniff" the injection frequency in the following manner: Connect a coax cable which has 1 to 2 inches of ground shield removed from one end to the frequency counter. Insert this end into coil form L103 in the receiver injection circuit. This should provide enough signal to accurately gate the counter. For each frequency, adjust the receiver channel element for the injection frequency ± 75 Hz. (Calculate injection frequency using appropriate formula at beginning of alignment procedure.)

RECEIVER METER READINGS

When the receiver is properly aligned, meter deflections should fall within the following limits. Where two numbers are given, the readings are non-preamp/preamp.

Switch Position	Meter 1	Meter 2	Meter 3
Meter Reading (no signal)	12/14 uA (min) 30/32 uA (max)	20 uA (min) 28 uA (max)	10 uA (min)
Function Metered	Limiters/Detector	Detector Alignment	Receiver Injection

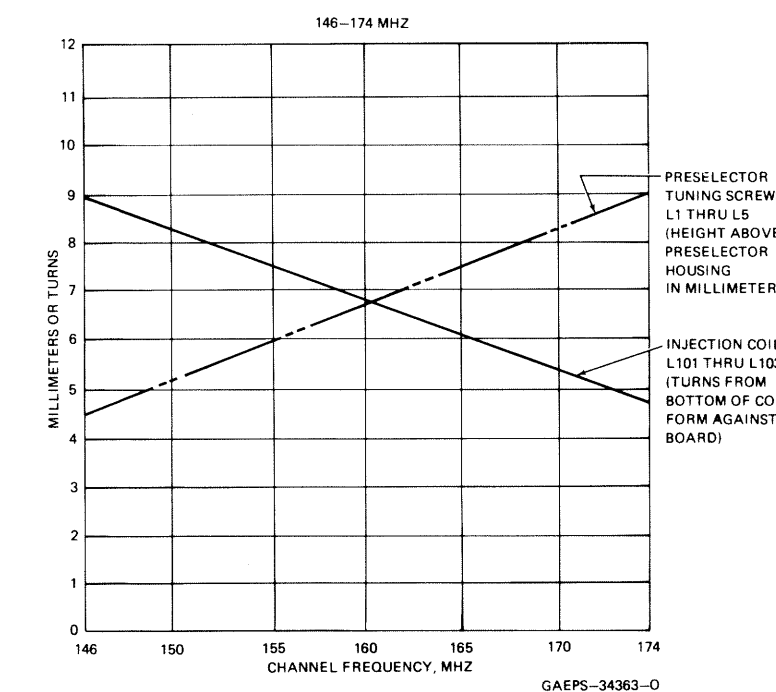
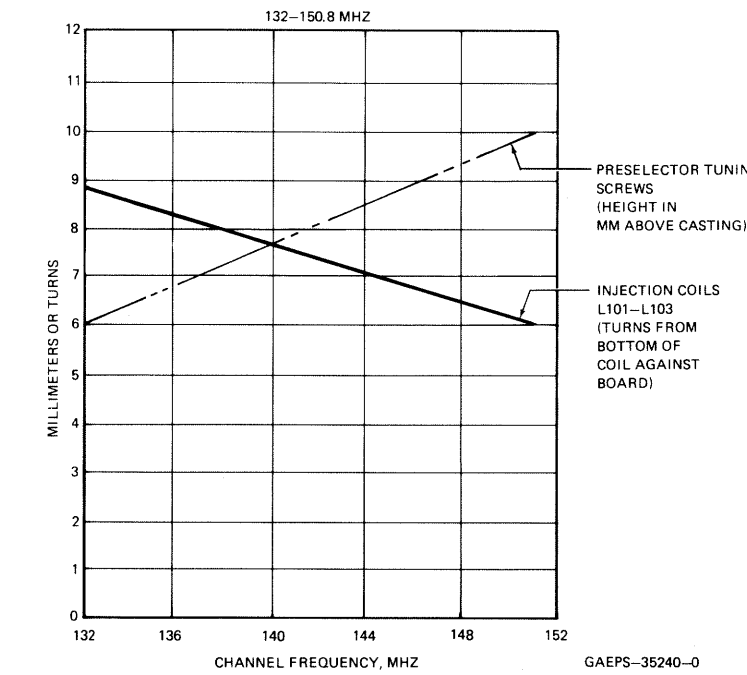

Coil Preset Charts

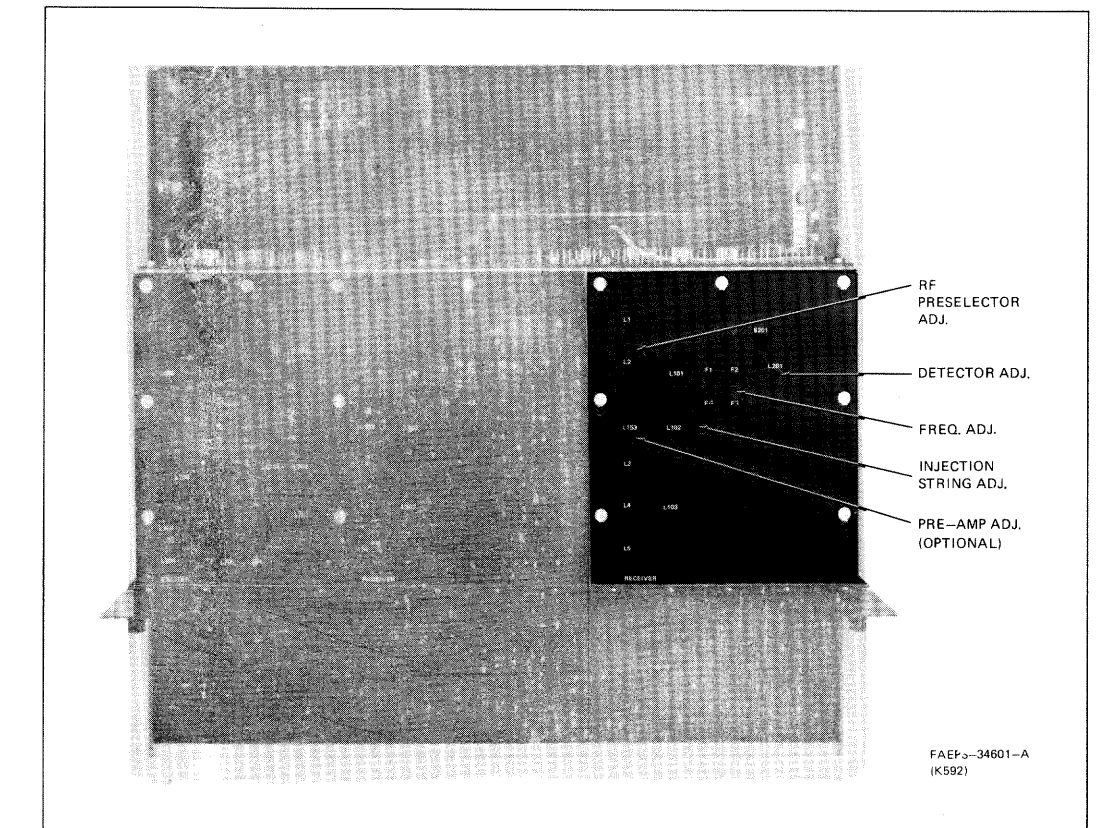
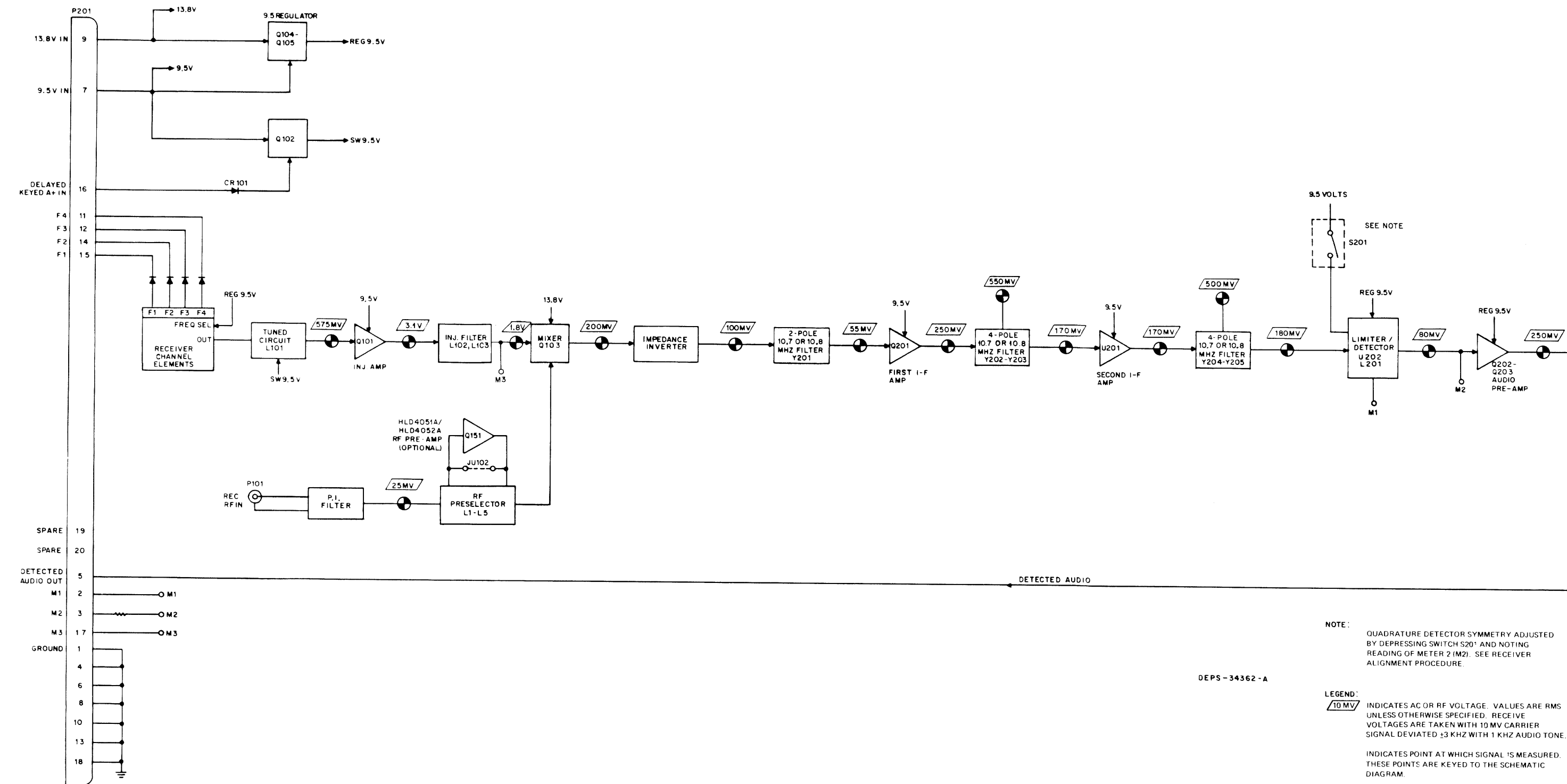
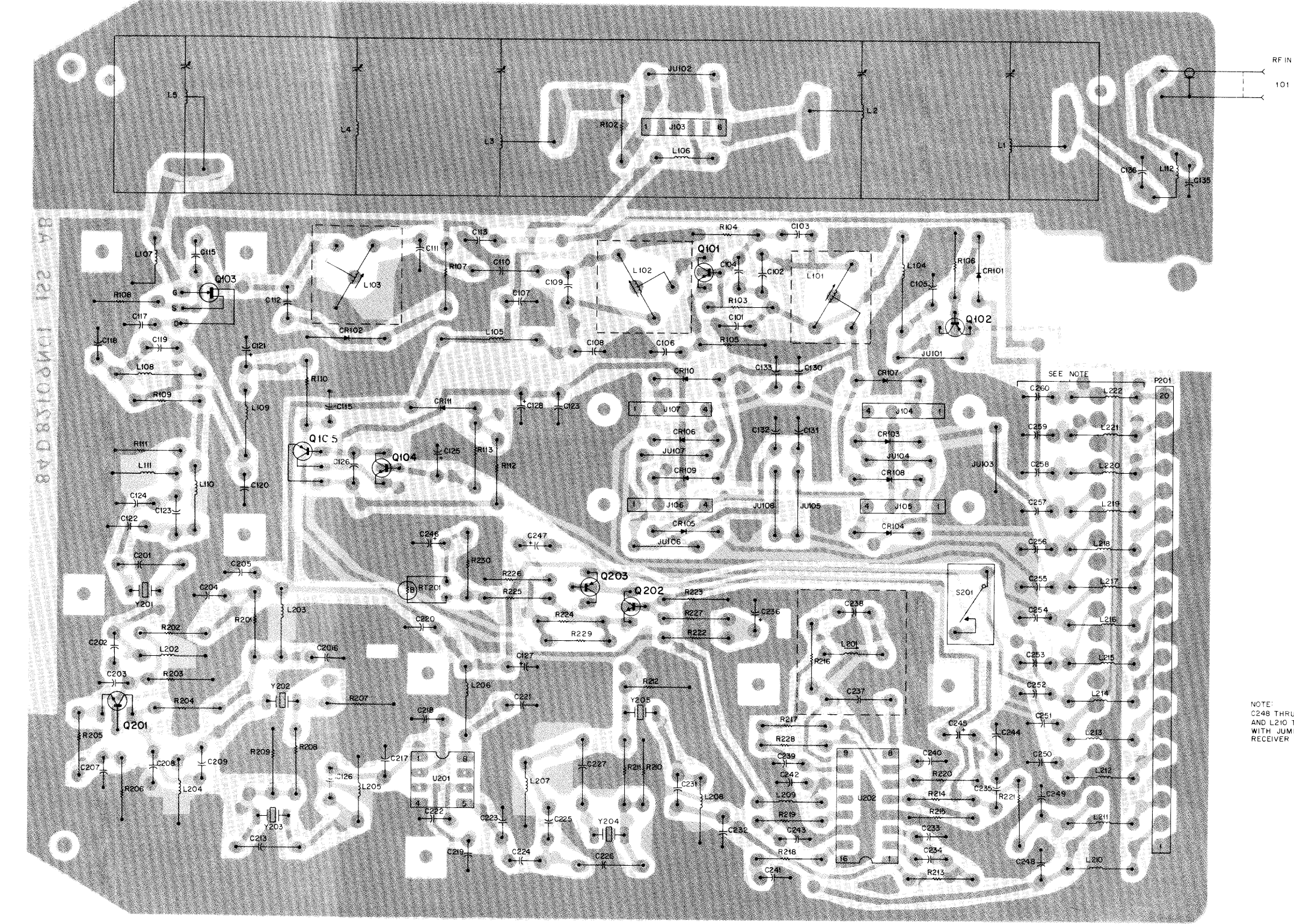

Figure 2. Receiver Alignment Adjustment Locations

RECEIVER MAINTENANCE



RECEIVER CIRCUIT BOARD DETAIL



RF PREAMPLIFIER

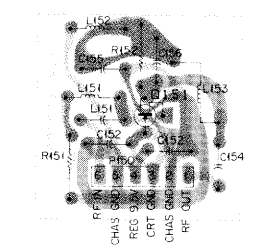

SHOWN FROM SOLDER SIDE

LEGEND
 L = 136-144 MHz (HLD4051A)
 H = 146-174 MHz (HLD4052A)

NOTE: C248 THRU C260 ARE DELETED AND L210 THRU L222 ARE REPLACED WITH JUMPERS FOR MODEL TR6 6172A RECEIVER ONLY.

SOLDER SIDE - 80 DEPS-34340-0
 COMPONENT SIDE - 80 DEPS-34341-0
 OL - 80 DEPS-34342-0

RECEIVER MAINTENANCE

RECEIVER SCHEMATIC DIAGRAM

MODEL	FREQUENCY (MHZ)
TRD6171A	132-150.8
TRD6181A	
TRD6191A	
TRD6172A	
TRD6182A	146-174
TRD6192A	

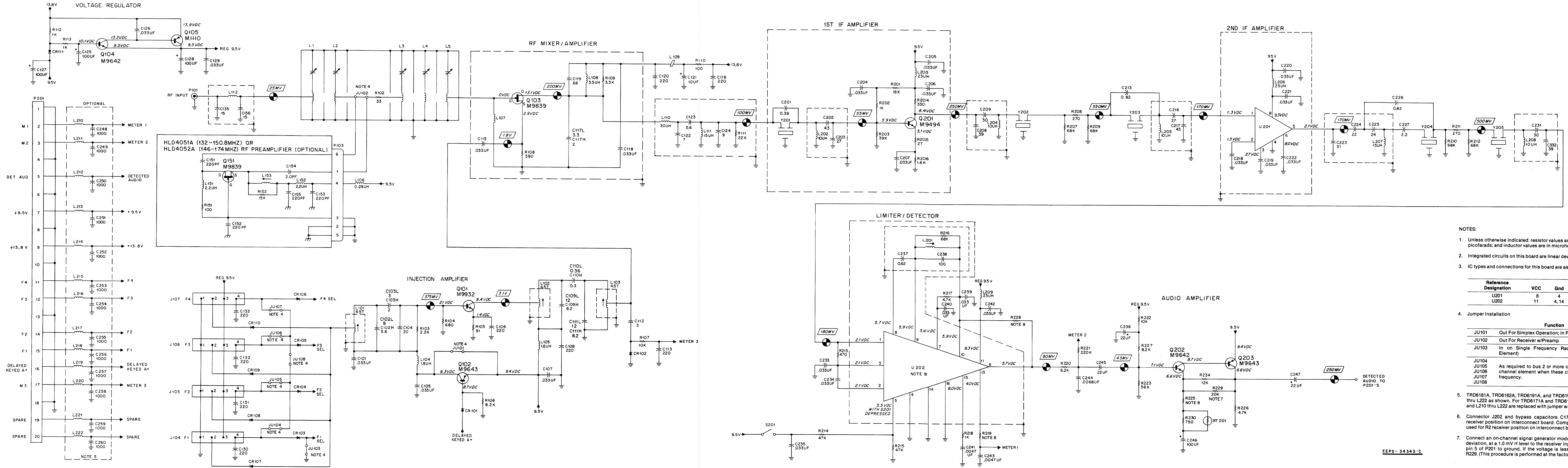
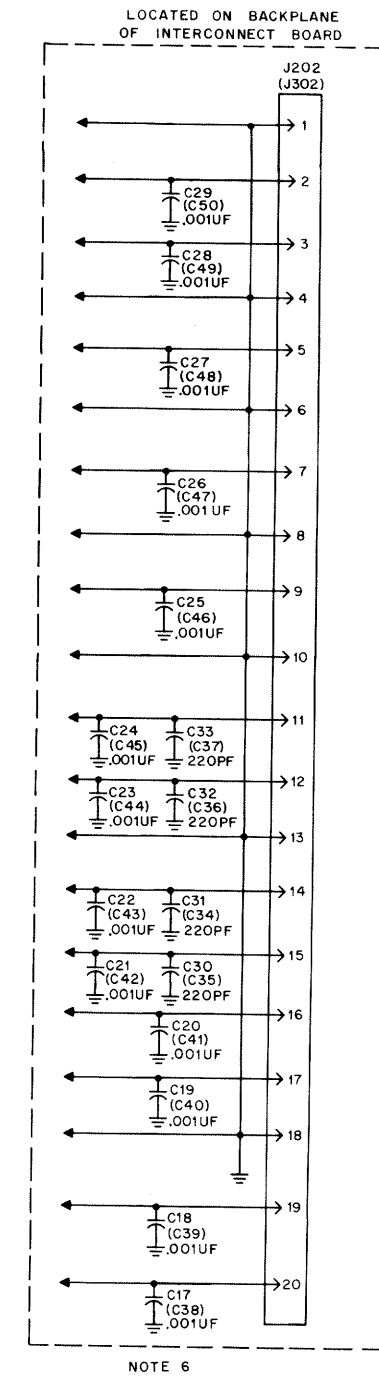

- NOTES:
- Unless otherwise indicated, resistor values are in ohms; capacitor values are in picofarads; and inductor values are in microhenries.
 - Integrated circuits on this board are linear devices.
 - IC types and connections for this board are as follows:
- | Reference Designation | VCC | Gnd |
|-----------------------|-----|-------|
| U201 | 8 | 4 |
| U202 | 11 | 4, 14 |
- Jumper Installation
- | Jumper | Function |
|--------|--|
| JU101 | Out For Simplex Operation; In For RPTR Operation |
| JU102 | Out For Receiver w/Preamp |
| JU103 | In on Single Frequency Radios (To Enable F1 Channel Element) |
| JU104 | As required to bus 2 or more channel select lines to a single channel element when these channels use the same receiver frequency. |
| JU105 | |
| JU106 | |
| JU107 | |
- TRD6181A, TRD6182A, TRD6191A, and TRD6192A use C248 thru C260 and L210 thru L222 as shown. For TRD6171A and TRD6172A, C248 thru C260 are deleted and L210 thru L222 are replaced with jumper wires.
 - Connector J202 and bypass capacitors C17-C29 and C30-C33 used for R1 receiver position on interconnect board. Component designators shown in () used for R2 receiver position on interconnect board.
 - Connect an on-channel signal generator modulated with a 1.0 kHz tone, 3 kHz deviation, at a 1.0 mV r.l level to the receiver input. Measure the ac voltage from pin 5 of P201 to ground. If the voltage is less than 200 mV rms, then cut out R229. (This procedure is performed at the factory prior to shipment.)
- EPRS-34343-C

PARTS LISTS SHOWN ON BACK OF THIS DIAGRAM

parts list

TRD6171A, TRD6172A 10.7 MHz I-F, Receiver, Non-Filtered

TRD6181A, TRD6182A 10.7 MHz I-F, Receiver, Filtered

TRD6191A, TRD6192A 10.8 MHz I-F, Receiver, Filtered

PL-7936-D

REFERENCE SYMBOL	MOTOROLA PART NO.	DESCRIPTION
		capacitor, fixed: pF ± 5%; 50 V: unless otherwise stated
C101	21-11021H06	.033 uF + 80-20%
C102L	21-82204B31	8.0 ± 0.25 pF
C102H	21-82204B75	5.6 ± 0.25 pF
C103L	21-11022G12	3 ± 0.25 pF
C103H	21-11022G08	2 ± 0.25 pF
C104	21-11022G37	20
C105	21-11021H06	.033 uF + 80-20%
C106	21-11021E05	220 ± 10%
C107	21-11021H06	.033 uF + 80-20%
C108	21-11021E05	220 ± 10%
C109L	21-11022H29	12
C109H	21-11022H23	8.1 ± 0.5 pF; N150
C110L	21-842041	0.36
C110H	21-82450B04	0.3 ± 10%; 500 V
C111L	21-11022H29	12
C111H	21-11022H23	8.2 ± 0.5 pF; N150
C112	21-11022G12	3 ± 0.25 pF
C113	21-11021E05	220 ± 10%
C115	21-11021H06	.033 uF + 80-20%
C116	21-11021E05	220 ± 10%
C117L	21-11014H13	3.3 ± 0.25 pF
C117H	21-11022G08	2 ± 0.25 pF
C118	21-11021H06	.033 uF + 80-20%
C119	21-11022G50	68
C120	21-11021E05	220 pF ± 10%
C121	23-11019A21	10 uF ± 20%; 35 V
C122	21-82989E17	7 ± 0.25 pF; 500 V
C123	21-83406D64	5.6 ± 0.25 pF
C124	21-82989E21	9 ± 0.25 pF; 500 V
C125	23-11019A46	100 uF ± 20%; 25 V
C126	21-11021H06	.033 uF + 80-20%
C127, 128	23-11019A46	100 uF ± 20%; 25 V
C129	21-11021H06	.033 uF + 80-20%
C130 thru 133	21-11021E05	220 ± 10%
C135, 136	21-11022G34	15
C201	21-82450B07	0.39; 500 V
C202	21-11022G45	43
C203	21-11022G40	27
C204 thru 207	21-11021H06	.033 uF + 80-20%
C208	21-11022G44	39
C209	21-11022G41	30
C213	21-82450B44	0.82; 500 V
C216	21-11022G40	27
C217	21-11022G45	43
C218 thru 222	21-11021H06	.033 uF + 80-20%
C223	21-11014H42	51; 100 V
C224	21-11022G38	22
C225	21-11022G39	24
C226	21-82450B44	0.82; 500 V
C227	21-82450B17	2.2; 500 V
C231	21-11022G41	30
C232	21-11022G44	39
C233 thru 235	21-11021H06	.033 uF + 80-20%
C236	23-11019A27	22 uF ± 20%; 25 V
C237	21-82450B46	0.62 ± 5%; 500 V
C238	21-82358G12	100; 100 V; N080
C239, 240	21-11021H06	.033 uF + 80-20%
C241	21-11021E21	0.047 uF ± 10%
C242	21-11021H06	.033 uF + 80-20%
C243	21-11021E21	0.047 uF ± 10%
C244	21-11017B07	.0068 uF ± 10%
C245	23-11019A27	22 uF ± 20%; 25 V
C246	23-11019A46	100 uF ± 20%; 25 V
C247	23-11019A27	22 uF ± 20%; 25 V
C248 thru 260	21-11021E13	1000 (TRD6182A, 6192A)
		diode: (see note)
CR101	48-83654H01	silicon
CR102	48-82139G01	germanium
CR103 thru 110	48-83654H01	silicon
CR111	48-83654H02	silicon
		connector, plug:
J103	28-80181B01	male; 6-contact
J104 thru 107	28-80096A01	male; 4-contact
		coil, rf:
L1L	24-80032A07	helical; VIO
L1H	24-80032A02	helical; RED
L2L	24-80032A08	helical; BRN
L2H	24-80032A03	helical; ORG
L3L	24-80032A09	helical; GRN
L3H	24-80032A05	helical; NAT
L4L	24-80032A06	helical; BLU
L4H	24-80032A01	helical; NAT
L5L	24-80032A10	helical; BLU
L5H	24-80032A04	helical; YEL
L101, 102	24-80065A01	4-1/2 turns; coded RED
L103	24-80065A03	4-1/2 turns; coded YEL
L104, 105	24-82549D29	choke; 1.8 uH
L106	24-82723H04	choke; 0.29 uH
L107	24-83884G12	117 nH (8-1/2 turns); coded RED
L108	24-82835G11	choke; 3.5 uH
L109	24-83961B02	5 turns; coded GRN

REFERENCE SYMBOL	MOTOROLA PART NO.	DESCRIPTION
L110	24-83397L11	choke; 30 uH
L111	24-83397L08	choke; 15 uH
L112	24-83884G08	73 nH; 5-1/2 turns; coded ORG
L201	24-84419D04	23-1/2 turns
L202	24-83397L07	choke; 10 uH
L203	24-82723H03	choke; 23 uH
L204, 205	24-83397L07	choke; 10 uH
L206	24-82723H03	choke; 23 uH
L207	24-83397L08	choke; 15 uH
L208	24-83397L07	choke; 10 uH
L209	24-82723H03	choke; 23 uH
L210 thru 222	24-83961B01	choke; 3 turns (BRN) (TRN6181A, TRD6182A, TRN6191A, TRD6192A) resistor jumper (TRN6171A, TRD6172A only)
	or 6-11009B23	
		connector, receptacle:
P101	9-82872N01	female
P200, P201	9-83497F05	female; 10-contact (2 ea.)
		transistor: (see note)
Q101	48-869932	NPN; type M9932
Q102	48-869643	PNP; type M9643
Q103	48-869839	field-effect; type M9839
Q104	48-869642	NPN; type M9642
Q105	48-84411L10	PNP; type M1110
Q201	48-869494	NPN; type M9494
Q202	48-869642	NPN; type M9642
Q203	48-869643	PNP; type M9643
		resistor, fixed: ± 5%; 1/4 W: unless otherwise stated
R102	6-11009A13	33
R103	6-11009A57	2.2k
R104	6-11009A45	680
R105	6-11009A24	91
R106	6-11009A71	8.2k
R107	6-11009A73	10k
R108	6-11009A39	390
R109	6-11009A61	3.3k
R110	6-11009A25	100
R111	6-11009A81	22k
R112, 113	6-11009A49	1k
R201	6-11009A79	18k
R202	6-11009A49	1k
R203	6-11009A87	39k
R204	6-11009A37	330
R205	6-11009A11	27
R206	6-11009A54	1.6k
R207	6-11009A93	68k
R208	6-11009A35	270
R209, 210	6-11009A93	68k
R211	6-11009A35	270
R212	6-11009A93	68k
R213	6-11009A41	470
R214, 215	6-11009A89	47k
R216	6-11009A93	68k
R217	6-11009A65	4.7k
R218	6-11009A49	1k
R219	6-11009A91	56k
	or	
	6-11009A94	75k (see note 8 on schematic)
R220	6-11009A68	6.2k
R221	6-11009B06	220k
R222	6-11009A73	10k
R223	6-11009A91	56k
R224	6-11009A76	12k
R225	6-11009A53	1.5k
	or	
	6-11009A51	1.2k (see note 8 on schematic)
R226	1009A65	4.7k
R227	6-11009A71	8.2k
R228	6-11009A66	5.1k
R229	6-11009A80	20k
R230	6-11009A46	750
		thermistor:
RT201	6-83600K02	1k @ 25°C
		switch:
S201	40-82765M01	spst
		integrated circuit: (see note)
U201	51-83629M05	second i-f amplifier
U202	51-83629M60	quad detector
	or	
	51-84561L84	(see note 8 on schematic)
		crystal: (see note)
Y201	91-80011E04	10.7 MHz (TRD6172A, TRD6182A, TRN6171A, TRD6181A)
	or 48-84396K07	10.8 MHz (TRD6192A, TRD6191A)
Y202 thru 205	91-80011E05	10.7 MHz (TRD6172A, TRD6182A, TRD6171A, TRD6181A)
	or 48-84396K06	10.8 MHz (TRD6192A, TRD6191A)
		mechanical parts
	2-80045A01	NUT, retainer: M5 x 0.8; 5 used

REFERENCE SYMBOL	MOTOROLA PART NO.	DESCRIPTION
	3-3375	SCREW, tapping: 6-20 x 5/16"; 14 used
	3-80012A04	SCREW, set; 5 used
	3-84256M01	SCREW, tapping; 8 used
	5-10277A17	GROMMET, plastic
	5-84220B01	GROMMET, panel; 8 used
	15-80008A01	HOUSING
	26-80062C01	SHIELD, IC
	26-80121A01	SHIELD, can; 5 used
	26-80144B03	SHIELD, mixer
	26-80196A01	SHIELD, coil; 3 used
	26-82868N01	SHIELD, 1st i-f
	26-82870N01	SHIELD, input
	26-84173N01	SHIELD, mag.
	26-82871N01	SHIELD, quad
	26-83264P01	SHIELD, coil; L201
	26-84173N01	SHIELD, magnetic; L201
	26-83347N01	SHIELD, 2nd i-f
	26-83596M01	SHIELD, antenna
	26-84243B03	SHIELD, mixer
	45-83824N01	CARD, ejector; 2 used
	75-05295B01	INSULATOR, xtal; 5 used

note: For optimum performance, diodes, transistors, and integrated circuits must be ordered by Motorola part numbers.

LEGEND

L = 132-150.8 MHz (HLD4051A)

H = 146-174 MHz (HLD4052A)

HLD4051A and HLD4052A Preampifier Boards

PL-6036-E

REFERENCE SYMBOL	MOTOROLA PART NO.	DESCRIPTION
		capacitor, fixed:
C151, 152, 153	21-83596E10	220 pF ± 20%; 500 V
C154H	21-83406D52	2 pF ± .25 pF; 500 V
C154L	21-80067A01	1.5 pF ± .25 pF; 500 V
C155	21-83596E10	220 uF ± 20%; 500 V
C156H		not used
C156L	21-83406D52	2 pF ± .25 pF; 500 V
		connector, receptacle:
P112	9-80180B01	female; 6 contacts
		coil:
L151, 152	24-82549D48	choke; 2.2 uH
L153	24-80031A02	5-1/2 turns (coded grn)
		transistor: (see note)
Q151	48-869839	field-effect; type M9839
		resistor, fixed:
R151	6-124A25	100 ± 5%; 1/4 W
R152	6-124A77	15k