INSTRUCTION BOOK

**RF DIRECTIONAL
THRULINE® WATTMETER
MODEL APM-16**



**Electronic Corporation
Cleveland (Solon) Ohio USA**

©Copyright 2002 by Bird Electronic Corporation
Instruction Book Part Number 920-APM16 Rev. C

Thruline® and Termaline® are registered trademarks
of Bird Electronic Corporation

Safety Precautions

The following are general safety precautions that are not necessarily related to any specific part or procedure, and do not necessarily appear elsewhere in this publication. These precautions must be thoroughly understood and applied to all phases of operation and maintenance.

Keep Away From Live Circuits

Operating personnel must at all times observe general safety precautions. Do not replace components or make adjustments to the inside of the test equipment with the high voltage supply turned on. To avoid casualties, always remove power.

Shock Hazard

Do not attempt to remove the RF transmission line while RF power is present. Radiated RF power is a potential health hazard.

Do Not Service or Adjust Alone

Under no circumstances should any person reach into an enclosure to service or adjust the equipment except in the presence of someone who is capable of rendering aid.

Safety Earth Ground

An uninterruptible safety earth ground must be supplied from the main power source to test instruments. Grounding one conductor of a two conductor power cable is not sufficient protection. Serious injury or death can occur if this grounding is not properly installed.

Resuscitation

Personnel working with or near high voltages should be familiar with modern methods of resuscitation.

Safety Symbols

WARNING

Warning notes call attention to a procedure, which if not correctly performed, could result in personal injury.

CAUTION

Caution notes call attention to a procedure, which if not correctly performed, could result in damage to the instrument.



This symbol appears on the equipment indicating there is important information in the instruction manual regarding that particular area. See page 15 for specific cautions.

👉 Note: Calls attention to supplemental information

Warning Statements

The following warnings appear in the text where there is danger to operating and maintenance personnel, and are repeated here for emphasis.

WARNING

Never attempt to connect or disconnect RF equipment from the transmission line while RF power is being applied. Leaking RF energy is a potential health hazard.

WARNING

RF voltage may be present in element socket. Keep element in socket during operation.

Caution Statements

The following equipment cautions appear in the text whenever the equipment is in danger of damage, and are repeated here for emphasis.

CAUTION

For low reflection measurements, do not rotate the reflected power element to read forward power. Damage to the element or wattmeter could result.

CAUTION

To prevent damage from battery leakage, remove the battery if the unit will not be used for more than two weeks.

CAUTION

Handle elements with care. Calibration could be disturbed if they are dropped.

CAUTION

Do not attempt to remove the RF center conductor. This will damage the line section.

Safety Statements



USAGE

ANY USE OF THIS INSTRUMENT IN A MANNER NOT SPECIFIED BY THE MANUFACTURER MAY IMPAIR THE INSTRUMENT'S SAFETY PROTECTION.

USO

EL USO DE ESTE INSTRUMENTO DE MANERA NO ESPECIFICADA POR EL FABRICANTE, PUEDE ANULAR LA PROTECCIÓN DE SEGURIDAD DEL INSTRUMENTO.

BENUTZUNG

WIRD DAS GERÄT AUF ANDERE WEISE VERWENDET ALS VOM HERSTELLER BESCHRIEBEN, KANN DIE GERÄTESICHERHEIT BEEINTRÄCHTIGT WERDEN.

UTILISATION

TOUTE UTILISATION DE CET INSTRUMENT QUI N'EST PAS EXPLICITEMENT PRÉVUE PAR LE FABRICANT PEUT ENDOMMAGER LE DISPOSITIF DE PROTECTION DE L'INSTRUMENT.

IMPIEGO

QUALORA QUESTO STRUMENTO VENISSE UTILIZZATO IN MODO DIVERSO DA COME SPECIFICATO DAL PRODUTTORE LA PROIZIONE DI SICUREZZA POTREBBE VENIRNE COMPROMESSA.



SERVICE

SERVICING INSTRUCTIONS ARE FOR USE BY SERVICE - TRAINED PERSONNEL ONLY. TO AVOID DANGEROUS ELECTRIC SHOCK, DO NOT PERFORM ANY SERVICING UNLESS QUALIFIED TO DO SO.

SERVICIO

LAS INSTRUCCIONES DE SERVICIO SON PARA USO EXCLUSIVO DEL PERSONAL DE SERVICIO CAPACITADO. PARA EVITAR EL PELIGRO DE DESCARGAS ELÉCTRICAS, NO REALICE NINGÚN SERVICIO A MENOS QUE ESTÉ CAPACITADO PARA HACERLO.

WARTUNG

ANWEISUNGEN FÜR DIE WARTUNG DES GERÄTES GELTEN NUR FÜR GESCHULTES FACHPERSONAL.

ZUR VERMEIDUNG GEFÄHRLICHE, ELEKTRISCHE SCHOCKS, SIND WARTUNGSARBEITEN AUSSCHLIEßLICH VON QUALIFIZIERTEM SERVICEPERSONAL DURCHZUFÜHREN.

ENTRETIEN

L'EMPLOI DES INSTRUCTIONS D'ENTRETIEN DOIT ÊTRE RÉSERVÉ AU PERSONNEL FORMÉ AUX OPÉRATIONS D'ENTRETIEN. POUR PRÉVENIR UN CHOC ÉLECTRIQUE DANGEREUX, NE PAS EFFECTUER D'ENTRETIEN SI L'ON N'A PAS ÉTÉ QUALIFIÉ POUR CE FAIRE.



RF VOLTAGE MAY BE PRESENT IN RF ELEMENT SOCKET - KEEP ELEMENT IN SOCKET DURING OPERATION.

DE LA TENSION H.F. PEUT ÊTRE PRÉSENTE DANS LA PRISE DE L'ÉLÉMENT H.F. - CONSERVER L'ÉLÉMENT DANS LA PRISE LORS DE L'EMPLOI.

HF-SPANNUNG KANN IN DER HF-ELEMENT-BUCHSE ANSTEHEN - ELEMENT WÄHREND DES BETRIEBS EINGESTÖPSELT LASSEN.

PUEDA HABER VOLTAJE RF EN EL ENCHUFE DEL ELEMENTO RF - MANTENGA EL ELEMENTO EN EL ENCHUFE DURANTE LA OPERACION.

IL PORTAELEMENTO RF PUÒ PRESENTARE VOLTAGGIO RF - TENERE L'ELEMENTO NELLA PRESA DURANTE IL FUNZIONAMENTO.

About This Manual

This instruction book covers the Bird APM-16 RF Directional Thruline Wattmeter.

This instruction book is arranged so that essential safety information appears in the front of the book. Reading the Safety Precautions Section before operating the equipment is strongly advised. The remainder of the book is divided into chapters and sections.

Operation

First time users should read Chapter 1 - Introduction, Chapter 3 - Installation, and Chapter 2 - Theory of Operation, to get an overview of equipment capabilities and installation. An experienced operator can refer to Chapter 4 - Operating Instructions. All instructions necessary to operate the equipment appears in this chapter.

Maintenance

All personnel should be familiar with the preventive maintenance found in Chapter 5 - Maintenance. If a failure should occur, the troubleshooting section will aid in isolating and correcting the cause. Parts lists and specifications are also in this chapter

Changes to This Manual

We have made every effort to ensure this manual is accurate. If you should discover any errors or if you have suggestions for improving this manual, please send your comment to our factory. This manual may be periodically updated. When inquiring about updates to this manual refer to the part number and revision level on the title page.

Table of Contents

Safety Precautions	i
About This Manual	vi
Introduction	1
Description.	1
Theory of Operation	3
Travelling Wave Viewpoint	3
Coupling Circuit	3
Load Power	5
Standing vs. Travelling Waves	5
ρ vs. ϕ	6
Low Reflection.	9
Transmitter Monitoring.	9
Component Testing	10
Frequency Response	11
Impedance Mismatch	12
Installation	13
Battery	13
Elements	13
Connecting RF Power	14
Absorption Wattmeter	14
Operating Instructions	15
Normal Operation	15
Load Matching.	18
Maintenance	21
Troubleshooting	21
Maintenance	22
Cleaning	22
Contact Adjustment	22
Battery	23
Zero Adjust	23
Repair	23
“QC” Connectors	23
Meter	23
Instrumentation Module	23

Calibration	24
Calibration Environment	24
Equipment Required	24
Calibrating	26
Storage	27
Customer Service	27
Specifications	28
Replacement Parts List	29
Available "QC" Type Connectors	30

The Bird APM-16 is an insertion wattmeter designed to measure RF power and load match in 50 ohm transmission lines. It has a maximum VSWR of 1.05 for frequencies up to 1000 MHz. The meter provides direct readings in watts with an expanded linear scale for easy reading. The scale is graduated for 25, 50, and 100 full scale. Elements are available in a variety of power and frequency ranges (See the Bird Electronic Corporation Catalog for details).

Description

The Bird APM-16 is portable and rugged, with an aluminum housing. For additional protection, the microammeter is specially shock mounted. Bumpers on the base and back allow the meter to stand or lie flat. Refer to Figure 1 to identify components.

At each end of the line section are Bird Quick-Change RF connectors that may be interchanged with any other Bird "QC" connector. The wattmeter housing does not interfere with connector changes.

Figure 1
Outline Drawing

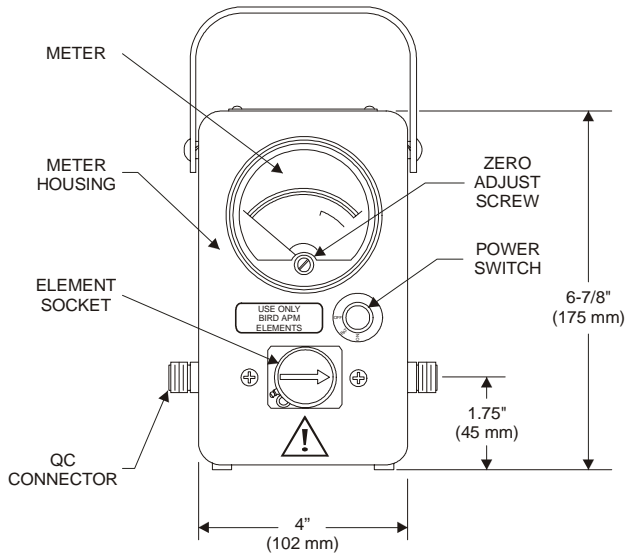

FRONT VIEW

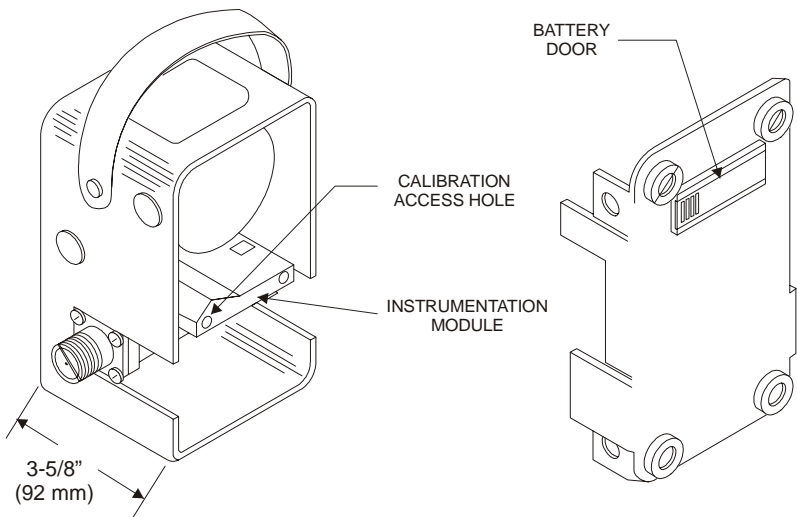

INSIDE-BACK REMOVED

**Travelling
Wave
Viewpoint**

The easiest way to visualize Thruline operation is from a travelling wave viewpoint. In transmission lines the voltages, currents, standing waves, etc., on any uniform line section result from the interaction of two travelling waves:

- The forward wave (and its power) travels from the source to the load. It has RF voltage E_f and current I_f in phase, with $E_f / I_f = Z_0$.
- The reflected wave (and its power) originates by reflection at the load and travels from the load back to the source. It has an RF voltage E_r and current I_r in phase, with $E_r / I_r = Z_0$.

Each wave is mathematically simple and has a constant power:

$$W_f = \text{Watts Forward} = E_f^2 / Z_0 = I_f^2 Z_0 = E_f I_f$$

$$W_r = \text{Watts Reflected} = E_r^2 / Z_0 = I_r^2 Z_0 = E_r I_r$$

Z_0 is the characteristic impedance of a uniform line section. For useful lines it is usually a pure resistance of 50 ohms. The RF circuit of the Bird APM-16 is a length of uniform air line with $Z_0 = 50$ ohms.

**Coupling
Circuit**

The Bird Plug-In Element contains a coupling circuit that samples the travelling waves. The element circuitry and its relationship to the rest of the Bird APM-16 are illustrated in Figure 2.

Figure 2
Schematic

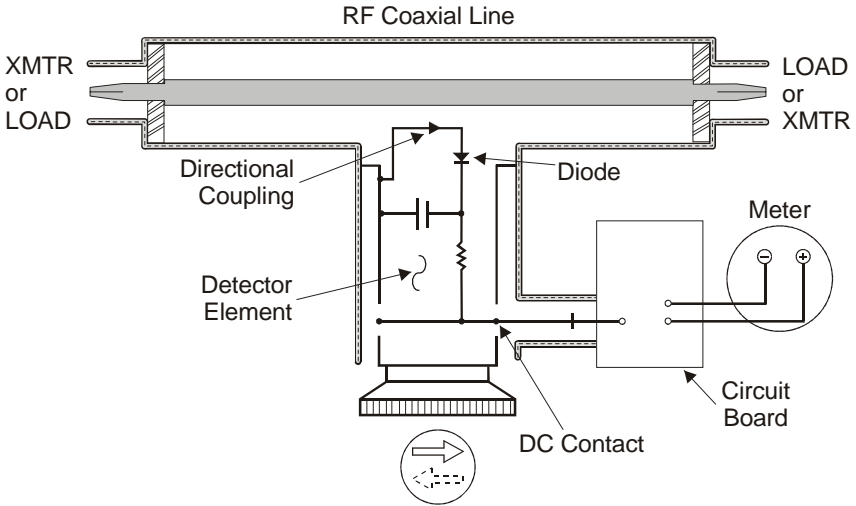

Current is produced in the coupling circuit by the travelling waves in the line section. Both inductive and capacitive coupling contribute to this. Inductive current flows in the direction of the travelling wave, while the capacitive current is independent of the direction of the travelling wave. Therefore, the inductive current produced by one travelling wave will add in phase with the corresponding capacitive current, while that produced by the wave travelling in the opposite direction will subtract. The additive or “arrow” direction is assigned to the forward wave.

The electrical characteristics of the element are carefully adjusted so that, for the reverse travelling wave, the inductive current will completely cancel the capacitive current. The result is directivity greater than 25 dB. Thus, the element is sensitive at either of its settings, but to only one of the two travelling waves. Thruline Wattmeter measurements are also independent of position along the transmission line.

Like similar diode devices, the Bird APM-16 indicates the carrier component of amplitude modulation, with very little response to side band components added by modulation.

Load Power For loads with a VSWR of 1.2 or less, the power dissipated in a load (W_l) is equal (with less than one percent error) to the forward power (W_f). When appreciable power is reflected, as with an antenna, it is necessary to use the exact load power, given by:

$$W_l = \text{Watts into Load} = W_f - W_r$$

Good load resistors, such as Bird Termline Loads, will give negligible reflected power.

**Standing vs.
Travelling
Waves**

As mentioned previously, the Thruline Wattmeter reacts to forward and reverse travelling waves to measure power in a transmission line. The standing wave viewpoint, also widely used, is highly developed both in theory and in practice. This viewpoint can be traced to the early use of slotted transmission lines.

The slotted line measures the standing wave ratio by mechanically positioning a voltage detector at peaks and nulls along a length of line section. Its drawbacks are that it is usually too long, too expensive for good accuracy, not portable, and too slow. These problems grow rapidly as the measurement frequency drops below 1000 MHz. The Thruline Wattmeter by comparison is fast, convenient, and accurate. It provides the same information as a slotted line except for the phase angle of the reflection coefficient (distance, load to minimum).

ρ vs. ϕ The simple relationships:

$$\rho = \frac{1 + \sqrt{\phi}}{1 - \sqrt{\phi}} \quad \text{and} \quad \phi = \left[\frac{\rho - 1}{\rho + 1} \right]^2$$

*Where ρ = VSWR
and ϕ = W_r / W_f*

can be used to convert between the standing wave ratio (ρ) and the reflected/forward power ratio (ϕ), which can be directly read from the ThruLine Wattmeter. The relationship between ρ and ϕ is graphed in Figure 3 and Figure 4.

 NOTE: Attenuation, measured in dB, can be derived from the power ratio by the equation $N_{db} = 10 \log \phi$.

VSWR scales and their attendant controls for setting the reference point have been intentionally omitted from the Bird APM-16. Experience using the ThruLine Wattmeter for transmitter tune-up, antenna matching, etc. will show that the power ratio measurement is as useful as the standing wave ratio.

A trial is suggested – forget about VSWR for a few days and think in terms of $\phi = W_r / W_f$. The meter readings, W_r and W_f , give a useful, approximate picture of the results without bothering to calculate the power ratio exactly. Consider that, for an antenna matching problem, the main objective usually is to minimize W_r . Anything done experimentally to this end will be seen when the element is in the reflected power position.

Figure 3
Percent Reflected Power vs. VSWR (1.0 – 1.3)

$$\phi = \frac{W_r}{W_f} \times 100 = \frac{\text{REFLECTED POWER}}{\text{FORWARD POWER}} \times 100$$

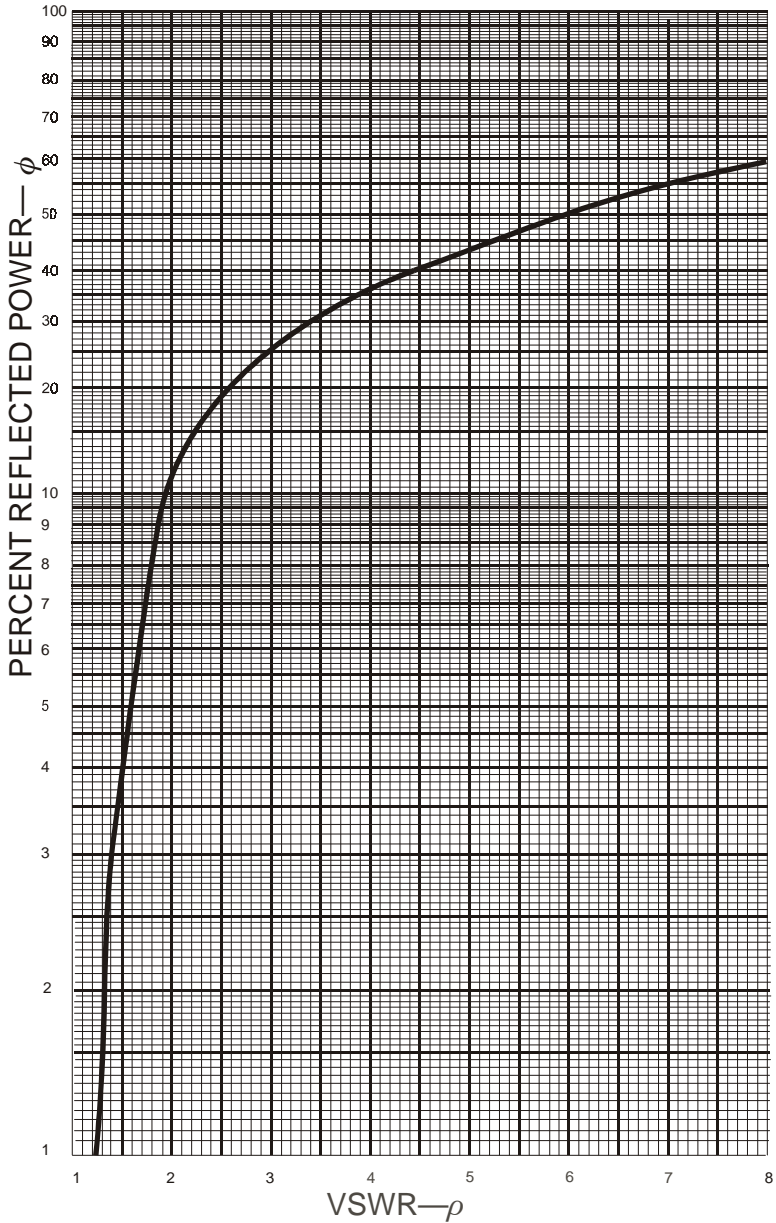
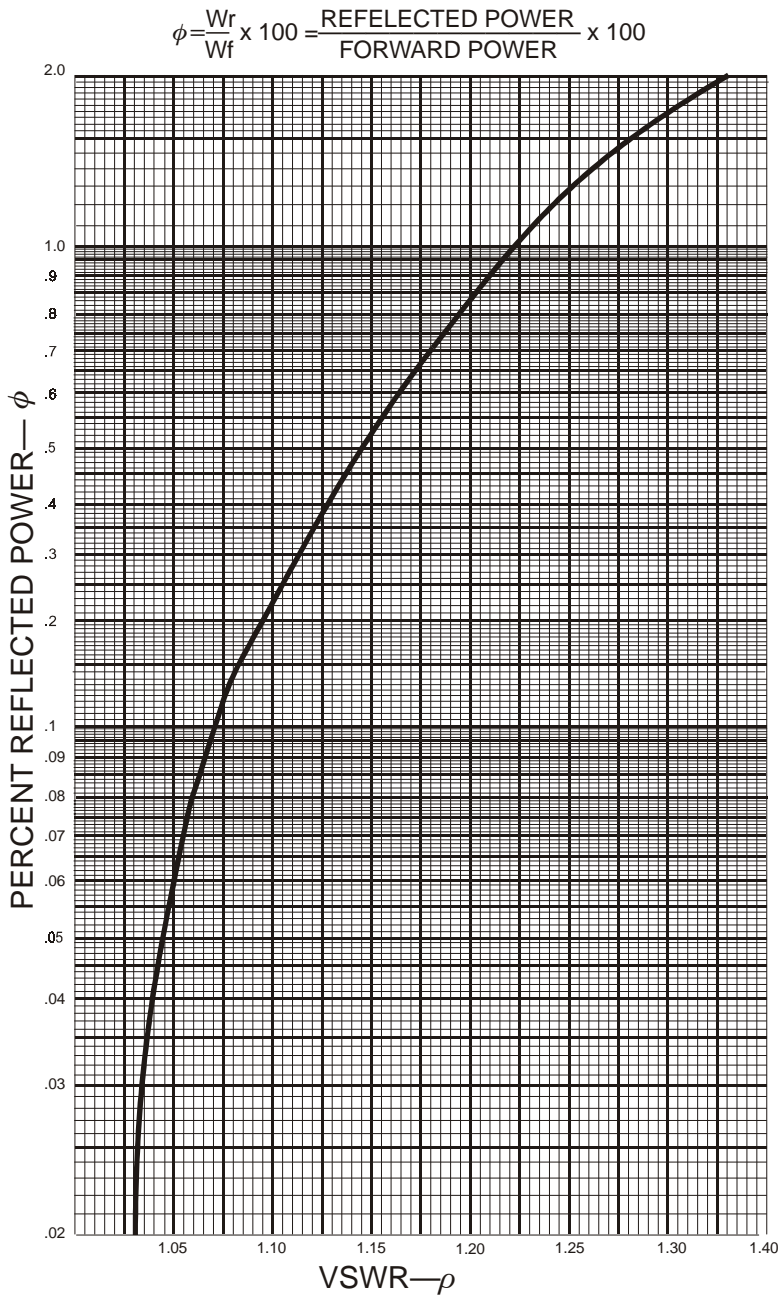

Figure 4
Percent Reflected Power vs. VSWR (1.0 – 8.0)



Low Reflection

$\phi = 10\%$ ($\rho = 2$) is the typical limit of antenna match. Further effort is frequently not worthwhile because below this level reflected power is hard to measure, and W_1 can not be significantly increased. TV and VHF transmitters are examples of systems requiring lower reflected power but for reasons other than maximizing power transmission.

CAUTION

For low reflection measurements, do not rotate the reflected power element to read forward power. Damage to the element or wattmeter could result.

When the same element is used to measure both forward and reflected power, meaningful readings are possible down to about $\phi = 5\%$ ($\rho = 1.5$). For accurate measurement of very low levels of reflected power, i.e. $\phi = 0.6\%$ ($\rho = 1.17$), use a second element rated at one tenth of the full scale power of the forward element. This method should not be used with element ranges differing by more than 10:1.

For example, consider an 80 watt transmitter and a Bird APM-16 with 100 and 10 watt elements. Measure W_f with the 100 W element. Measure W_r with the 10 W element (make sure the arrow points towards the transmitter). W_r can be measured down to at least 0.5 W, so that $\phi = 0.5 / 80$ or about 0.6%, corresponding to $\rho = 1.17$.

Transmitter Monitoring

The Thruline Wattmeter can be used for continuous monitoring of transmitter output or reflected power, for instance while checking intermittent antenna or line faults.

Component Testing

The Bird APM-16 is very helpful in component testing, and may be employed in several ways:

1. Insertion VSWR or ϕ can be measured by placing the component between the wattmeter and a good load resistor.
2. Attenuation (power lost by heat in a line) as well as insertion VSWR or ϕ can be measured by inserting the unknown line between two Thruline Wattmeters, or between a Thruline Wattmeter and a Termaline Absorption Wattmeter.

👉 NOTE: Very small attenuations require allowance for normal instrument errors. To correct for this without any calculations, connect the wattmeters directly, with no line between them, and adjust their zero settings.

3. Line loss using open circuit calibration: The high directivity of elements can be exploited in line loss measurements, because of the equality of forward and reflected power with the load connector open or short circuited. In this state the forward and reflected waves have equal power, so that $\phi = 100\%$ and $\rho = \infty$. Open circuit testing is preferred to short circuit, because a high quality open circuit is easier to create than a high quality short. To measure insertion loss, use a high quality open circuit to check forward and reverse power equality, then connect an open-circuited, unknown line to the wattmeter. The measured ϕ is the attenuation for *two* passes along the line (down and back). The attenuation can then be compared with published data for line type and length (remember to halve N_{db} or double the line length to account for the measurement technique).

This measurement should be supplemented by either time domain reflectometry or dc continuity and leakage checks, since the attenuation measurement alone cannot account for faults such as open or short circuits partway down the line.

👉 NOTE: Very small attenuations require allowance for normal instrument errors. Make sure to note exact readings, or their difference, on the initial equality check, and correct for this.

Frequency Response

Bird Plug-In Elements have a flat frequency response over their specified operating range. A sample set of curves is shown in Figure 5. Notice that for the low power element, the rolloff outside its frequency band is more pronounced than for the high power elements. For example, at 40 MHz the 10C element will have a loss of 4 dB, giving a reading of about 40% of the true value. For the 100C, the loss will only be about 1 dB, for a reading at 80% of the true value, and the 500C should be within the normal 5% of full scale tolerance.

Figure 5
Representative Frequency Response

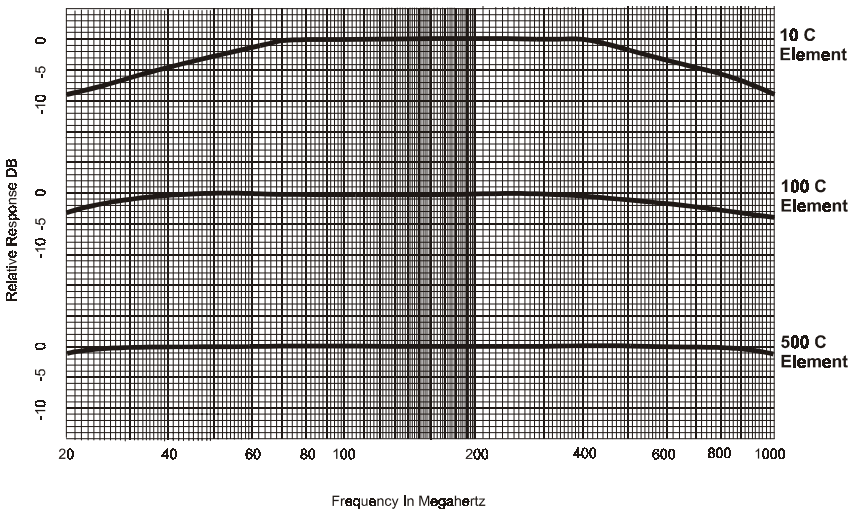

These curves are typical for all element types (H, A, B, C, D, ...) at their respective frequencies. Since C elements have a frequency range of 100 - 250 MHz, response curves for other element types can be approximated by replacing the 100 and 250 MHz points on the chart with the extremes of the element's frequency range, and recalculating the other frequency points accordingly. For example, for a B element (range 50 - 125 MHz) simply divide all frequencies by two. For an E element (range 400 - 1000 MHz) multiply all frequencies by four.

Harmonics or subharmonics that lie outside of the frequency range of the element may exist in the circuit under test. A rough approximation of the element's response to harmonics can be made with these curves. Using an element for measurements outside of its frequency range is not recommended. The response curves presented are only typical, and not guaranteed.

Impedance Mismatch

There may be cases where it is necessary to use the Bird APM-16 with a non-50 ohm transmission line. If the reflected power is less than 10% and the frequency is below 200 MHz, the resulting mismatch will not be too serious. At higher frequencies or higher reflected power levels, the load impedance will change when the wattmeter is removed from the circuit.

When the line and load impedances are known, the system's VSWR can be calculated by dividing the larger impedance by the smaller. Remember that the VSWR ratio must always be greater than 1.

For example, consider using a Bird APM-16 to tune a 70 ohm line. If the load impedance is also 70 ohms, the wattmeter will measure a VSWR of $70/50 = 1.4$. However, if you remove the wattmeter, the VSWR will actually be 1.0. If the load impedance is 35.7 ohms instead, the VSWR will be $50/35.7 = 1.4$ with the wattmeter and $70/35.7 = 2.0$ without it. Caution must therefore be used, since both good and bad matches can have the same measured VSWR. In this case, the correct impedance can be determined by slightly changing the load impedance. When the load impedance is near 70 ohms, the Bird 43 will read increasing VSWR as the load impedance is increased.

☞ NOTE: When working with non-50 ohm lines, it is especially important to calculate the load power by subtracting the reflected power from the forward power.

CAUTION

To prevent damage from battery leakage, remove the battery if the unit will not be used for more than two weeks.

WARNING

Never attempt to connect or disconnect RF equipment from the transmission line while RF power is being applied. Leaking RF energy is a potential health hazard.

Battery The 9 V battery must be installed before operation. Figure 1 on page 2 shows the location of the battery access door. Slide this open and connect the battery.

When transporting or storing the Bird APM-16, be sure the power switch is set to OFF. In any other position, there is a slight drain on the battery.



WARNING

RF voltage may be present in element socket. Keep element in socket during operation.

Elements The Bird APM-16 uses Bird Plug-In Elements to make measurements. The element's frequency range and maximum power are listed on its label. The transmitter test frequency should be within the band of the element used. The arrow on the element points in the direction of power flow that the meter will read.

To make measurements, insert an element into the line section socket and rotate it against one of the stops. Contacts on opposite sides of the element connect with a spring finger in the socket when the element is in the forward or reverse position. A small catch at the corner of the socket face presses on the shoulder of the element to keep it in proper alignment (see Figure 6).

Figure 6
Securing an element

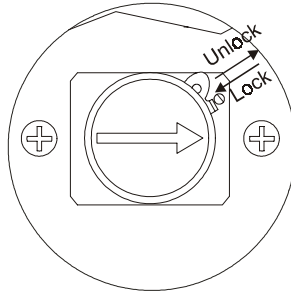

**Connecting
RF Power**

Insert the Bird APM-16 in 50 ohm coaxial transmission lines. The RF source can be connected to either side of the wattmeter.

**Absorption
Wattmeter**

Combining the Thruline Wattmeter with a Bird Termline Load creates an accurate absorption wattmeter. With this combination, readings only need to be taken in the forward direction because the reflected power will be negligible.

Chapter 4 Operating Instructions



WARNING
RF voltage may be present in element socket. Keep element in socket during operation.

Normal Operation

- Insert the element in the line section socket.
- To measure forward power, turn the element so that the arrow points towards the load.
- To measure reflected power, turn the element so that the arrow points towards the source.
- Turn on the RF source.
- Read the power using the scale whose full-scale marking matches the element's maximum power.

Figure 7
Element Direction

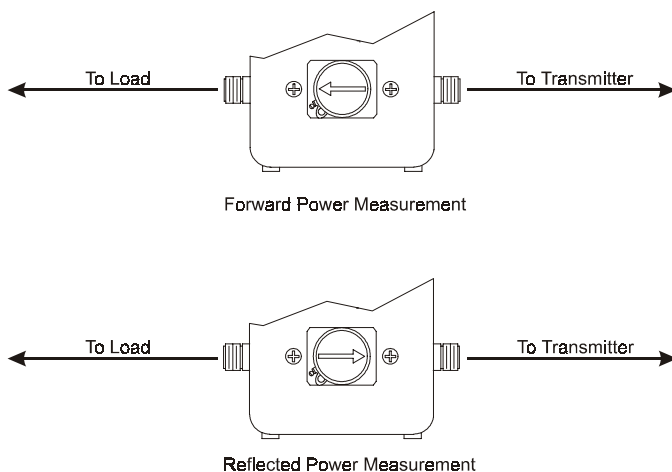

For your convenience, a pair of VSWR conversion graphs are included in this manual. With these charts, VSWR can be determined from the forward and reflected power. Find the intersection of the forward and reflected power measurements. The slanted line passing closest to this point is the VSWR.

Figure 8
 VSWR Conversion Graph (Reflected Power 0.2 – 20.0)

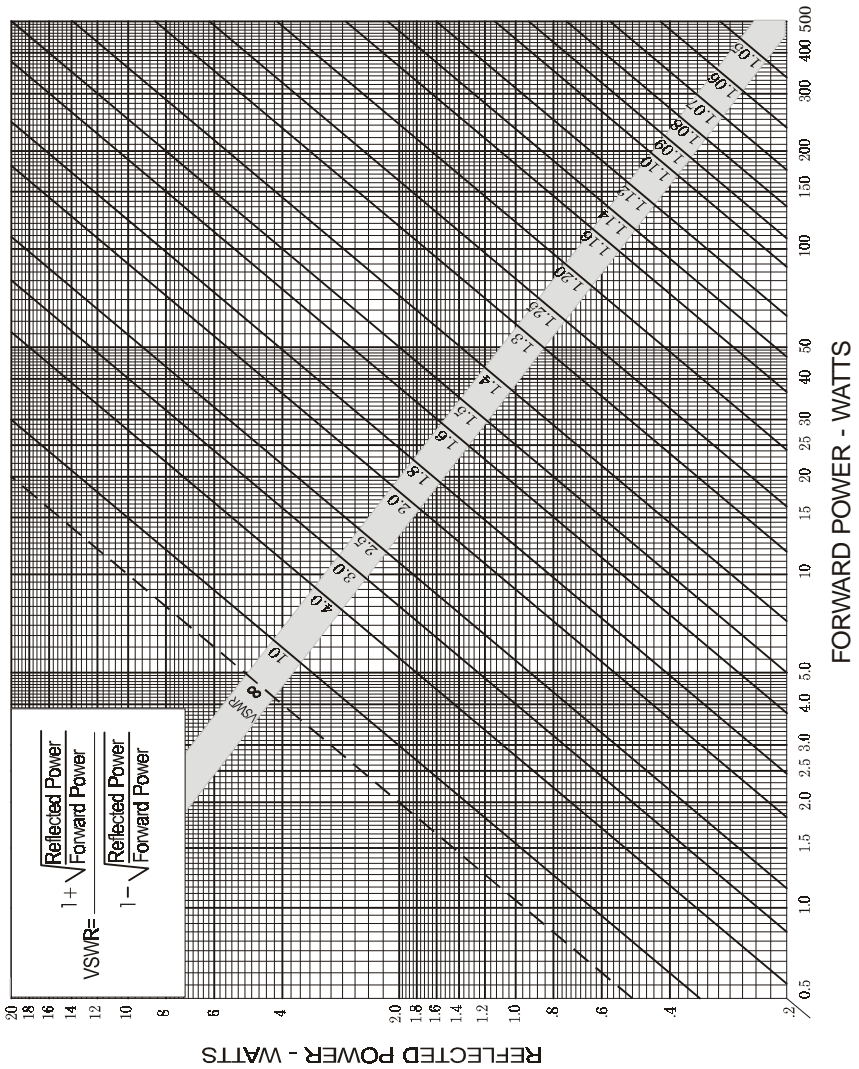
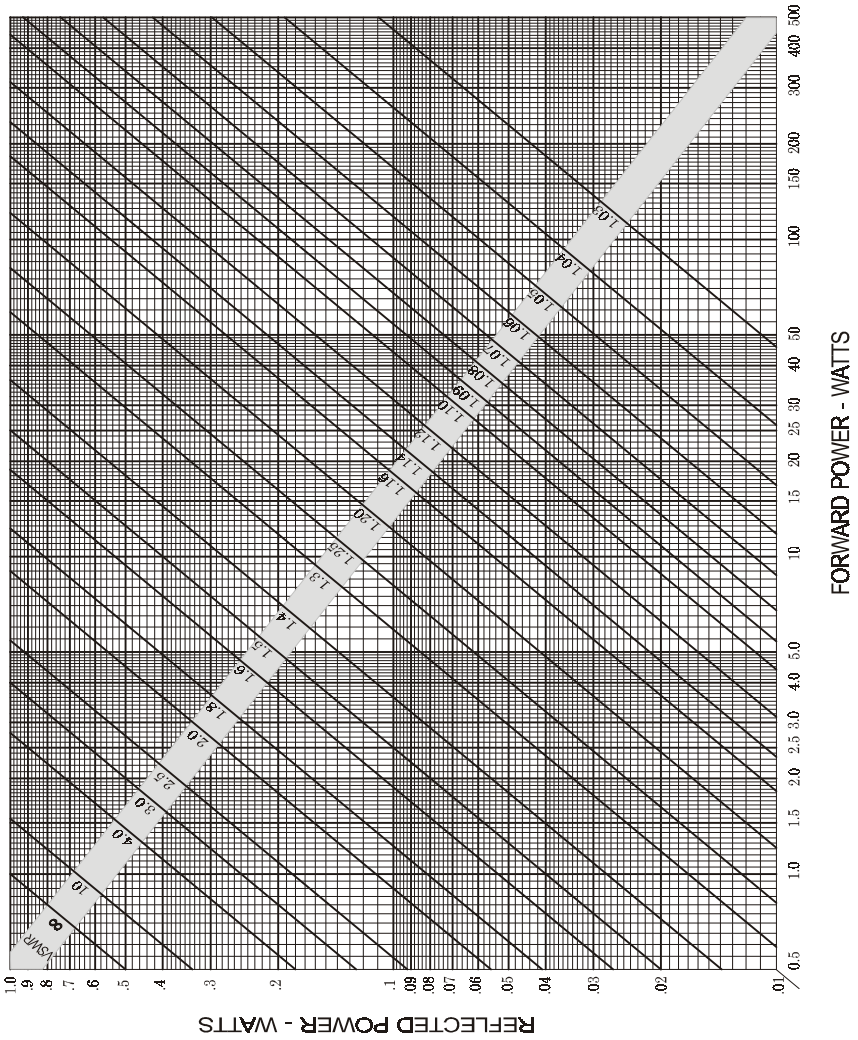

Figure 9
VSWR Conversion Graph (Reflected Power 0.01 – 1.00)



**Load
Matching**

When a Bird APM-16 is used to tune a load to a transmitter and a good match is obtained, removing it will not change the match quality. A good 50 ohm load can terminate a 50 ohm transmission line of any length without altering conditions at the transmitter. The wattmeter is just an additional length of 50 ohm line in series with the measurement.

When the load is not well matched, e.g. an antenna with a VSWR of 1.5 or 2.0, the line length between the load and the transmitter will transform the load impedance as seen at the transmitter. Removing the wattmeter shortens the total line length by four inches plus two connectors. This is still not significant at low frequencies where four to five inches is a small fraction of a wavelength, but at higher frequencies the frequency or power output of the transmitter may be affected.

Transmission line theory shows that if the line length changes by exactly $\frac{1}{2}$ wavelength, the impedance at the transmitter is unchanged. To have identical match quality with the Bird APM-16 in or out of the circuit, it is necessary to insert or remove $\frac{1}{2}$ wavelength worth of line (including the wattmeter). To do this, use a length of cable which, when added to the wattmeter, equals a $\frac{1}{2}$ wavelength at the frequency of interest. If more than one frequency is involved, a separate cable length is required for each. See Figure 10 for sample cable lengths.

 NOTE: Cable length shown (in inches) is measured from end to end of the outer conductor of the connectors, except for UHF or mini-UHF plugs where the cable length is measured from tip to tip of the center pins.

 NOTE: Dimensions shown are for solid polyethylene cable like RG-58C/U or RG-8/U, which have a velocity of propagation 66% of that of air. If RG-58 or RG-8 type cables containing foam polyethylene (velocity of propagation of 79%) are used, the dimensions in the graph must be multiplied by the ratio of the relative velocities; $79\% \div 66\% = 1.2$ in this case.

Figure 10
Cable Length / Wavelength Matching



The rugged and simple design of the Bird APM-16 means that it requires minimal routine maintenance.

Troubleshooting

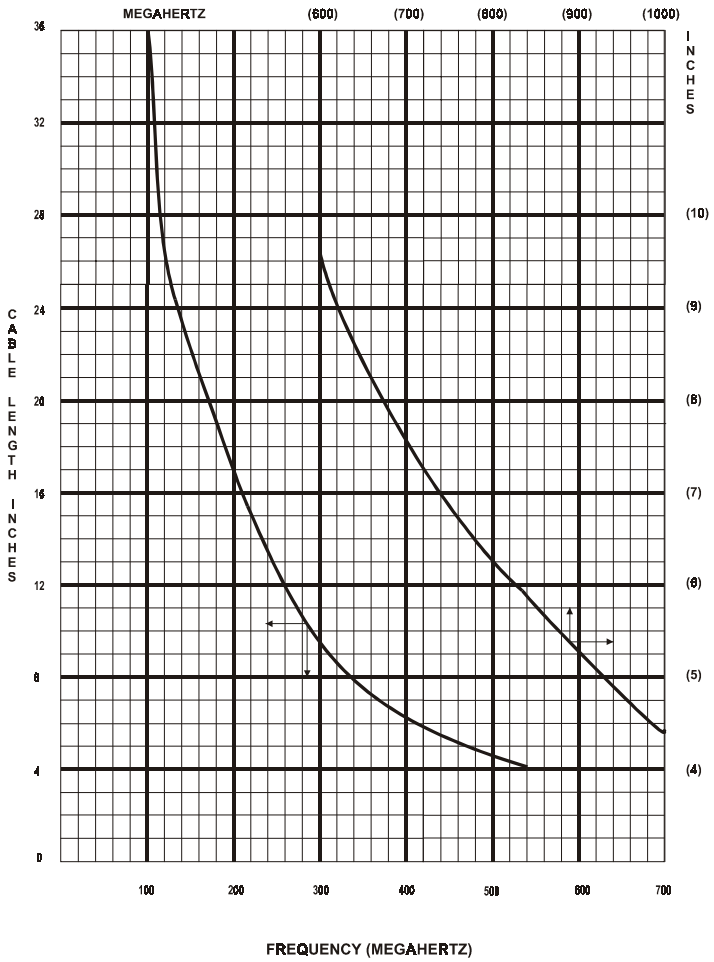
The following table contains troubleshooting information for problems that can occur during normal operation. Find the problem on the table, review possible causes, and perform the corrective action listed.

This manual does not list all malfunctions that may occur, or all corrective actions. If a malfunction is not listed or not corrected by the listed actions, contact the nearest Bird Service Center for assistance.

Problem	Possible Cause	Corrective Action
No meter reading	No RF power	Check RF source
	“Arrow” on element pointing wrong way	Rotate element
	Battery drained	Check the battery and replace if necessary
	DC contact bent	Adjust contact (page 22)
	Open or short circuit in meter leads	Replace defective leads
	Meter burned out or damaged	Return wattmeter for service
Intermittent or inconsistent meter readings	Dirty dc contact on element	Clean contact (page 22)
	Faulty transmission line or antenna	Inspect line
	Sticky or defective meter	Return wattmeter for service

High VSWR or reflected power	Foreign material in line section or in RF connectors	Clean connectors (page 22)
	Open or shorted transmission line	Inspect line
	Bad load or poor connectors	Inspect load, antenna, and connectors

Maintenance

Cleaning It is important to keep the following surfaces clean:

- Socket bore
- DC contacts on the element
- Teflon insulators

If any of the contacts or line connectors are dirty, clean them with a cotton swab dipped in commercial contact cleaner or isopropyl alcohol.

CAUTION

Do not attempt to remove the RF center conductor. This will damage the line section.
--

If the RF line section seems dirty, do not loosen any connections. Clean accessible components as described above and use dry, clean air to blow out the interior.

The outside of the meter housing can be cleaned with a soft cloth dampened with a mild detergent solution. Do not wipe the meter glass with a dry cloth, or a static charge could develop that would cause an erroneous meter indication.

Contact Adjustment

When cleaning the socket bore, do not disturb the spring finger of the dc contact. If necessary, the contact can be adjusted manually. The button must be out far enough to maintain good contact, but not so far as to interfere with easy entry of the element body.

Battery The accuracy of the unit may be reduced by a weak battery. To check the condition of the battery, set the power switch to BAT. If the pointer does not swing into the BATTERY TEST region, replace the battery.

Zero Adjust The meter's zero setting should be checked when no RF power is present. When no power is applied the pointer should rest exactly on zero. If adjustment is required, set the power switch to OFF and turn the zero screw until the pointer is set at zero (See Figure 1 on page 2 for screw location).

Repair

“QC” Connectors The Bird 43 is normally supplied with Quick-Change Female N type connectors. Other Bird “QC” connectors are available (see “Available “QC” Type Connectors” on page 30). To change a QC connector, remove the 8-32 screw at each corner of the connector and then pull it straight outward. Reverse this to install the new connector.

Meter To replace the meter:

1. Remove the back cover.
2. On the back of the meter, loosen both nuts securing the meter leads and remove the leads.
3. Remove the large Phillips screws securing the meter shock ring. These screws are on either side of the housing, even with the meter.
4. Pull the meter straight out. If necessary, the meter retaining ring and shock mount can be removed.
5. Replace the meter by reversing the steps above.

Instrumentation Module The instrumentation module contains the line section and circuit board chassis. To replace it:

1. Remove the back cover.
2. Use a 0.050" hex wrench, turning clockwise, to loosen the set screw in the power switch knob. Pull the knob straight off.

3. Unsolder the leads on the top of the circuit board chassis.
- 👉 NOTE: Note the color coding when unsoldering so the leads can be returned to their original positions.
4. Remove the phillips screws on the front of the unit, on either side of the element socket.
5. Pull the instrumentation module straight out.
6. Install a replacement module by reversing the steps above.

Calibration

Calibration of the Bird APM-16 will be required after replacing the meter or the instrumentation module, and also when the calibration certification expires.

👉 NOTE: Calibrating the unit, or disturbing the calibration label, within the one-year warranty period will void the warranty.

Calibration Environment

For best results, make sure that the workspace meets the following requirements:

- The workspace should be free from electrical noise and radiated signals. A Bird 43 equipped with a 4030 relative field strength element can be used to check the area for spurious radiation. Make sure the gain on the 4030 is set to maximum. If there is any meter deflection on the 43, the area is unsuitable for calibration.
- The workspace and equipment should be at a uniform and stabilized temperature, between 20 and 25°C (68 to 77°F).
- The relative humidity should be less than 50% and noncondensing.

Equipment Required

To calibrate the Bird APM-16, you will need the following equipment:

- Standard digital multimeter with dc voltmeter resolution of 0.01 V or better (Fluke Model 87)
- Bird 4401A200 plug-in calibration element

- Regulated dc power supply, supplying 2 ± 0.1 V
- 50 ohm coaxial cables (RG-58-U), no more than 3 feet (1 m) long
- BNC "T" adapter

Figure 11
Calibration Setup

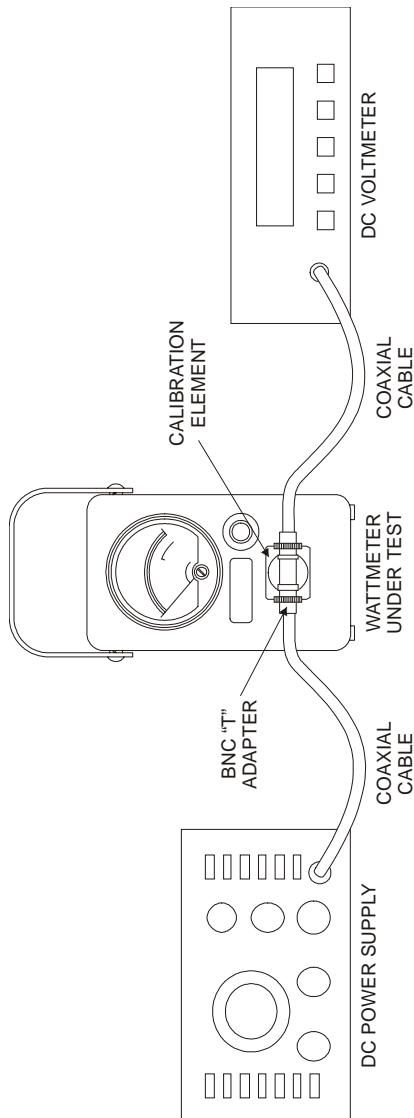

Calibrating

1. Remove any dust plug or element from the APM.
2. Allow the APM and all equipment to stabilize with respect to the workspace environment.
 - ☞ NOTE: The APM and the calibration element may require up to 24 hours for complete stabilization if brought from an extreme storage environment.
3. Set the APM to OFF and turn the zero screw until the pointer rests at zero (See Figure 1 on page 2 for screw location). Switching between BAT and OFF, rezero until a repeatable zero is obtained.
4. The calibration access hole is covered by a label showing the calibration date. Pierce the label inside the circle with an "X" in it (See Figure 1 on page 2 to locate the hole).
 - ☞ NOTE: Disturbing the calibration label within the one-year warranty period will void the warranty.
5. Connect the power supply, voltmeter, and calibration element as shown in Figure 11 above.
 - ☞ NOTE: The APM does not need to be connected at this time.
6. Turn on the voltmeter and power supply. Set the output to 2.00 ± 0.1 V. Allow the equipment to stabilize for the time recommended by the manufacturer, but for no less than five minutes.
7. Set the APM to ON and allow it a minimum of five minutes to stabilize.
8. After the equipment has stabilized, check the battery in the wattmeter by momentarily setting the power switch to BAT. If the pointer does not swing into the BATTERY TEST region, replace the battery, set the switch back to ON, and allow the APM to stabilize for another five minutes before continuing.
9. Insert the calibration element into the wattmeter. Rotate it in either direction until it stops, then rotate it back 90° to short circuit the contact to the line section body.
10. Rotate the calibration element in either direction until it stops.
11. Adjust the calibration potentiometer (through the calibration access hole) until the pointer rests at "25" on the upper scale.

Storage

CAUTION

To prevent damage from battery leakage, remove the battery if the unit will not be used for more than two weeks.

When storing the meter, keep an element or dust plug in the element socket to prevent the intrusion of dust and to prevent damage to the meter movement. Be sure the power switch is OFF. In any other position, there is a slight drain on the battery.

Customer Service

If you need to return the unit for any reason, contact the Bird Service Center for a return authorization. All instruments returned must be shipped prepaid and to the attention of Bird Service Center.

Service Facility

Bird Service Center

30303 Aurora Road
Cleveland (Solon), Ohio 44139-2794
Phone: (440) 519-2298
Fax: (440) 519-2326

Sales Facilities

For the location of the Sales Office nearest you, give us a call or visit our Web site at:

<http://www.bird-electronic.com>

Specifications

Frequency Range (Element Dependent)	2 MHz – 2.3 GHz
Power Range (Element Dependent)	1 W – 1 kW
Impedance, Nominal	50 ohms
VSWR, Insertion	1.05:1 max 2 MHz – 1 GHz
Accuracy	
10° to 35°C	± 4% of reading ± 1% of full scale
-20° to +50°C	± 6% of reading ± 2% of full scale
Peak/Average Ratio	> 10 dB
Settling Time	< 1 s
Meter	Shock mounted linear scale with expanded scales of 25, 50 and 100 full scale. Includes 5% overrange.
Connectors	Bird “QC” N Female normally supplied
Battery	Standard 9V battery. 200 hours operation, minimum.
Operating Position	Any
EMC	Complies with 89/336/EEC and 92/31/EEC
Emissions	EN 55011:1991 Class B
Immunity	EN 50082-2:1995
Safety	EN 61010-1:1993 in accordance with 79/23/EEC and 93/68/EEC
	Complies with IEC-1010-1, UL-1244, and CSA-231
Temperature, Operating	-4 to +122 °F (-20 to +50 °C)
Temperature, Storage	-13 to +149 °F (-25 to +65 °C)
Humidity	90% noncondensing max

Dimensions (Nominal)	3-5/8"L x 4"W x 6-7/8"H (92 x 102 x 175 mm)
Weight, Nominal	3 lb. (1.4 kg)
Finish	Black Powder Coat

Replacement Parts List

Description	Qty.	Part Number
Housing Assembly	1	4401A002
Cover Assembly	1	4401A013
Instrumentation Module	1	4410A003
Carrying Strap (Included in Housing Assembly)	1	8580A003
Dust Plug, Aluminum	1	3610-031
Selector Switch Knob	1	4401A014
Meter, dc	1	2080-066
Battery	1	5-1357
RF Connectors	2	See list below

Available “QC” Type Connectors

Connector	Part Number	Connector	Part Number
BNC-Female	4240-125	Open Term. # 10-32 Nut	4240-363
BNC-Male	4240-132	SC-Female	4240-090
C-Female	4240-100	SMA-Female	4240-336
C-Male	4240-110	SMA-Male	4240-334
HN-Female	4240-268	TNC-Female	4240-156
HN-Male	4240-278	TNC-Male	4240-160
LC-Female	4240-031	UHF-Female	4240-050
LC-Male	4240-025	UHF-Male	4240-179
LT-Female	4240-018	7/16” IEC (Jack) Type 169-4	4240-344
LT-Male	4240-012	7/16” IEC (Plug) Type 169-4	4240-080
Mini UHF- Female	4240-346	7/8” EIA	4240-002
N-Female	4240-062	1-5/8” EIA Fixed	4240-096
N-Male	4240-063	1-5/8” EIA Swivel	4240-208

Limited Warranty

All products manufactured by Seller are warranted to be free from defects in material and workmanship for a period of one (1) year, unless otherwise specified, from date of shipment and to conform to applicable specifications, drawings, blueprints and/or samples. Seller's sole obligation under these warranties shall be to issue credit, repair or replace any item or part thereof which is proved to be other than as warranted; no allowance shall be made for any labor charges of Buyer for replacement of parts, adjustment or repairs, or any other work, unless such charges are authorized in advance by Seller.

If Seller's products are claimed to be defective in material or workmanship or not to conform to specifications, drawings, blueprints and/or samples, Seller shall, upon prompt notice thereof, either examine the products where they are located or issue shipping instructions for return to Seller (transportation-charges prepaid by Buyer). In the event any of our products are proved to be other than as warranted, transportation costs (cheapest way) to and from Seller's plant, will be borne by Seller and reimbursement or credit will be made for amounts so expended by Buyer. Every such claim for breach of these warranties shall be deemed to be waived by Buyer unless made in writing within ten (10) days from the date of discovery of the defect.

The above warranties shall not extend to any products or parts thereof which have been subjected to any misuse or neglect, damaged by accident, rendered defective by reason of improper installation or by the performance of repairs or alterations outside of our plant, and shall not apply to any goods or parts thereof furnished by Buyer or acquired from others at Buyer's request and/or to Buyer's specifications. In addition, Seller's warranties do not extend to the failure of tubes, transistors, fuses and batteries, or to other equipment and parts manufactured by others except to the extent of the original manufacturer's warranty to Seller.

The obligations under the foregoing warranties are limited to the precise terms thereof. These warranties provide exclusive remedies, expressly in lieu of all other remedies including claims for special or consequential damages. SELLER NEITHER MAKES NOR ASSUMES ANY OTHER WARRANTY WHATSOEVER, WHETHER EXPRESS, STATUTORY, OR IMPLIED, INCLUDING WARRANTIES OF MERCHANTABILITY AND FITNESS, AND NO PERSON IS AUTHORIZED TO ASSUME FOR SELLER ANY OBLIGATION OR LIABILITY NOT STRICTLY IN ACCORDANCE WITH THE FOREGOING.

DECLARATION OF CONFORMITY

Manufacturer: Bird Electronic Corporation
30303 Aurora Road
Cleveland, Ohio 44139-2794

Product: Thruline Wattmeter

Models: APM-16

The undersigned hereby declares, on behalf of Bird Electronic Corporation of Cleveland, Ohio, that the above-referenced product, to which this declaration relates, is in conformity with the provisions of the following standards:

1. European Standard EN 55011:1991 - Emissions: Class B.
2. European Standard EN 50082-2:1995 - Immunity: Industrial Environment.

These standards are in accordance with Council Directive 89/336/EEC, on Electromagnetic Compatibility, as amended by Council Directive 92/31/EEC.

3. European Standard EN 61010-1:1993 - Safety, Group II.

This standard is in accordance with Council Directive 73/23/EEC and 93/68/EEC.

The technical documentation file required by this directive is maintained at the corporate headquarters of Bird Electronic Corporation, 30303 Aurora Road, Cleveland, Ohio 44139.



Ken DeVore
QA/Metrology Manager
Bird Electronic Corporation