

VHF FM Transceiver

VX-2100 Series VX-2200 Series

Service Manual

©2006 VERTEX STANDARD CO., LTD. EC061N90C

VERTEX STANDARD CO., LTD.
4-8-8 Nakameguro, Meguro-Ku, Tokyo 153-8644, Japan

VERTEX STANDARD
US Headquarters
10900 Walker Street, Cypress, CA 90630, U.S.A.

YAESU EUROPE B.V.
P.O. Box 75525, 1118 ZN Schiphol, The Netherlands

YAESU UK LTD.
Unit 12, Sun Valley Business Park, Winnall Close
Winchester, Hampshire, SO23 0LB, U.K.

VERTEX STANDARD HK LTD.
Unit 5, 20/F., Seaview Centre, 139-141 Hoi Bun Road,
Kwun Tong, Kowloon, Hong Kong

VERTEX STANDARD (AUSTRALIA) PTY., LTD.
Normanby Business Park, Unit 14/45 Normanby Road
Notting Hill 3168, Victoria, Australia

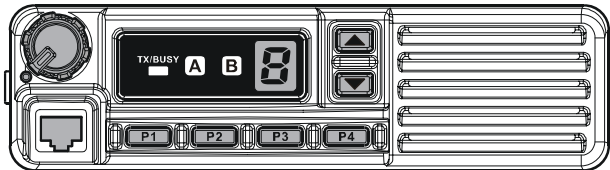

VX-2100 Series

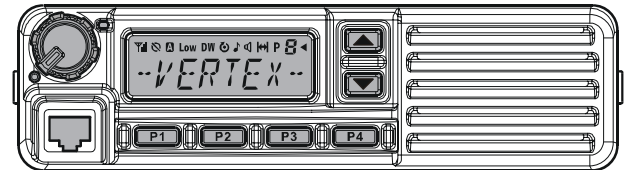

VX-2200 Series

Introduction

This manual provides the technical information necessary for servicing the **VX-2100/-2200 Series** Mobile Transceiver.

Servicing this equipment requires expertise in handling surface-mount chip components. Attempts by non-qualified persons to service this equipment may result in permanent damage not covered by the warranty, and may be illegal in some countries.

Two PCB layout diagrams are provided for each double-sided board in this transceiver. Each side of the board is referred to by the type of the majority of components installed on that side ("Side A" or "Side B"). In most cases one side has only chip components (surface-mount devices), and the other has either a mixture of both chip and leaded components (trimmers, coils, electrolytic capacitors, ICs, etc.), or leaded components only.

As described in the pages to follow, the advanced microprocessor design of the **VX-2100/-2200** allows a complete alignment of this transceiver to be performed without opening the case of the radio; all adjustments can be performed from the personal computer, using with the Vertex Standard VPL-1 Programming Cable and CE82 Software.

While we believe the information in this manual to be correct, Vertex Standard assumes no liability for damage that may occur as a result of typographical or other errors that may be present. Your cooperation in pointing out any inconsistencies in the technical information would be appreciated.

Important Note

This transceiver was assembled using Pb (lead) free solder, based on the RoHS specification.

Only lead-free solder (Alloy Composition: Sn-3.0Ag-0.5Cu) should be used for repairs performed on this apparatus. The solder stated above utilizes the alloy composition required for compliance with the lead-free specification, and any solder with the above alloy composition may be used.

Contents

Specifications	A-1	Board Units (Schematics, Layouts & Parts)	
DSUB 15-pin Accessory Connector	B-1	MAIN Unit	H-1
Exploded View & Miscellaneous Parts	C-1	FRONT-A Unit (VX-2100)	I-1
Block Diagram	D-1	FRONT-B Unit (VX-2200)	J-1
Circuit Description	E-1	Optional Units (Schematics, Layouts & Parts)	
Alignment	F-1	FVP-25 Encryption/DTMF Pager Unit	K-1
Installation of Option	G-1	FVP-36 Voice Inversion Type Encryption Unit	L-1

Specifications

General

Frequency Ranges:	134 -174 MHz
Number of Groups:	1 groups (VX-2100 Series) 8 groups (VX-2200 Series)
Number of Channels:	8 channels (VX-2100 Series) 128 channels (VX-2200 Series)
Power Supply Voltage:	13.6 V \pm 15%
Channel Spacing:	12.5 / 20 / 25 kHz
Current Consumption (Approx.):	TX: 11 A (50 W) or 6 A (25 W) RX: 2.5 A Standby: 250 mA
Operating Temperature Range:	-22 °F to +140 °F (-30 °C to +60 °C)
Frequency Stability:	Better than \pm 2.5 ppm
RF Input-Output Impedance:	50 Ω
Dimension (W x H x D):	6.5" x 1.8" x 6.1" inch (165 x 46 x 155 mm) (W/O knob)
Weight (Approx.):	2.87 lbs (1.3 kg)

Receiver (Measured by TIA/EIA-603-A)

Sensitivity (12 dB SINAD):	0.25 μ V
Intermediate Frequency:	1st: 67.65 MHz, 2nd: 450 kHz
Adjacent Channel Selectivity:	75 dB (25 kHz) 65 dB (12.5 kHz)
Intermodulation:	73 dB (25 kHz) 70 dB (12.5 kHz)
Spurious & Image Rejection:	90 dB
Audio Output:	Internal: 4 W @18 Ω , 5% THD External: 12 W @4 Ω , 5% THD

Transmitter (Measured by TIA/EIA-603-A)

Output Power :	50 / 25 / 10 W (50 W) 25 / 12.5 / 5 / 1 W (25 W)
Modulation:	16K0F3E, 11K0F3E
Maximum Deviation:	\pm 5 kHz (25 kHz) \pm 2.5 kHz (12.5 kHz)
Audio Distortion:	< 3 % (@1 kHz)
Conducted Spurious Emission:	70 dB below carrier

Specifications subject to change without notice or obligation.

DSUB 15-pin Accessory Connector

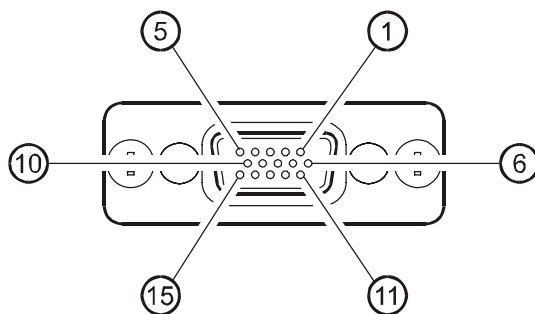

Pin 1: AF IN (ANALOG INPUT)

External Microphone Input. Nominal input level is 6 mV at 600-ohm.

When connect the External Microphone to this port, insert a 0.1 μ F coupling capacitor between the microphone and this port; as shown illustration.

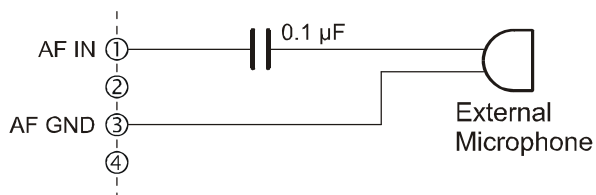

Pin 2: AF OUT (ANALOG OUTPUT)

Low-level receiver output. Peak signal level is 150 mV at 600-ohm.

Pin 3: AF GND

Ground for all logic levels and power supply return.

Pin 4: DC OUT (13.6 V DC OUTPUT)

Switched 13.6V output for supplying power to an accessory.

Pin 5: RSSI (ANALOG OUTPUT)

A DC voltage proportional to the strength of the signal currently being received (Receiver Signal Strength Indicator) is provided on this pin. This low impedance output is generated by the receiver IF sub-system and buffered by an internal op-amp. Typical output voltages are 1 V (@No Signal Input) through 2.0 V (@50 dB Signal Input).

Pin 6: EXT PTT

Shorting this port to ground causes the transceiver to be placed in the Transmit mode, while opening the connection to this port returns the transceiver to the Receive mode. Opening voltage is 5 V, closed current approx. 5 mA.

Pin 7: TRX

This port is intended for controlling an external TX/RX switching circuit. When the transceiver is placed in the the Receiver mode, this port is 5 V. When the transceiver is placed in the the Transmit mode, this port reduce to 0 V.

Pin 8: IGN (IGNITION SENSE FEATURE)

The VX-2100/-2200 may be automatically be switched to the STND-BY mode when the vehicle's ignition key is turned on. Maximum current is 20 mA.

Pin 9 - 12: ACC1 - ACC4 (ACCESSORY PORT)

These port features can be programmed via the CE82 programmer. Each port is open collector output which can sink approx. 100 mA when active. Max. output 16V. When the input is selected, it becomes active between 2V and 16V.

Pin 13: ACC5 (ACCESSORY PORT)

The port 5 is available to set only for Output function, and active logic is the opposite side against the Port 1 ~ 4.

Max.output 5V, closed current approx. 1 mA.
(CMOS output)

Pin 14: ACC6 (ACCESSORY PORT)

The port 6 is available to set only for Input function, and active logic is the opposite side against the Port 1 ~ 4.

Max.input 5V. (CMOS input)

Pin 15: GND

Chassis ground

Note

Exploded View & Miscellaneous Parts

VX-2100 FRONT PANEL

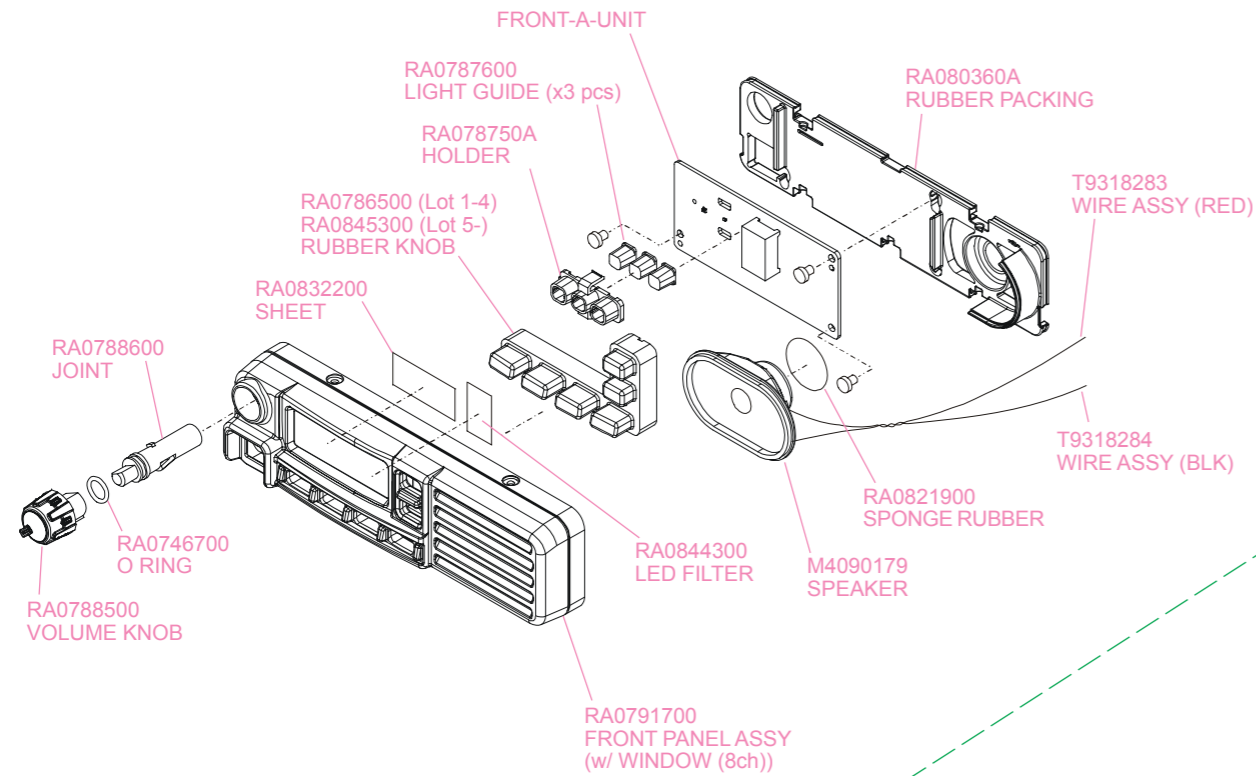

VX-2200 FRONT PANEL

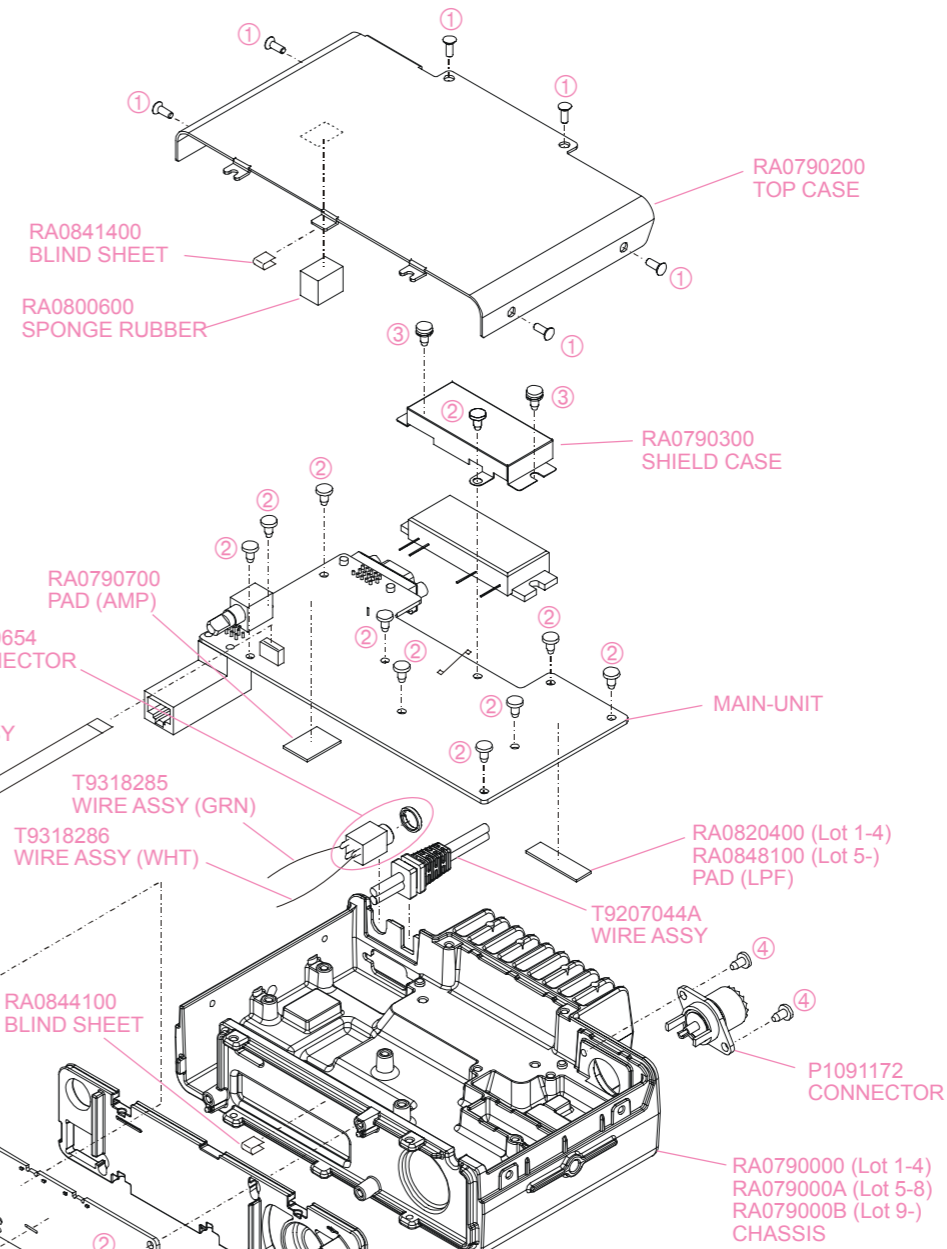
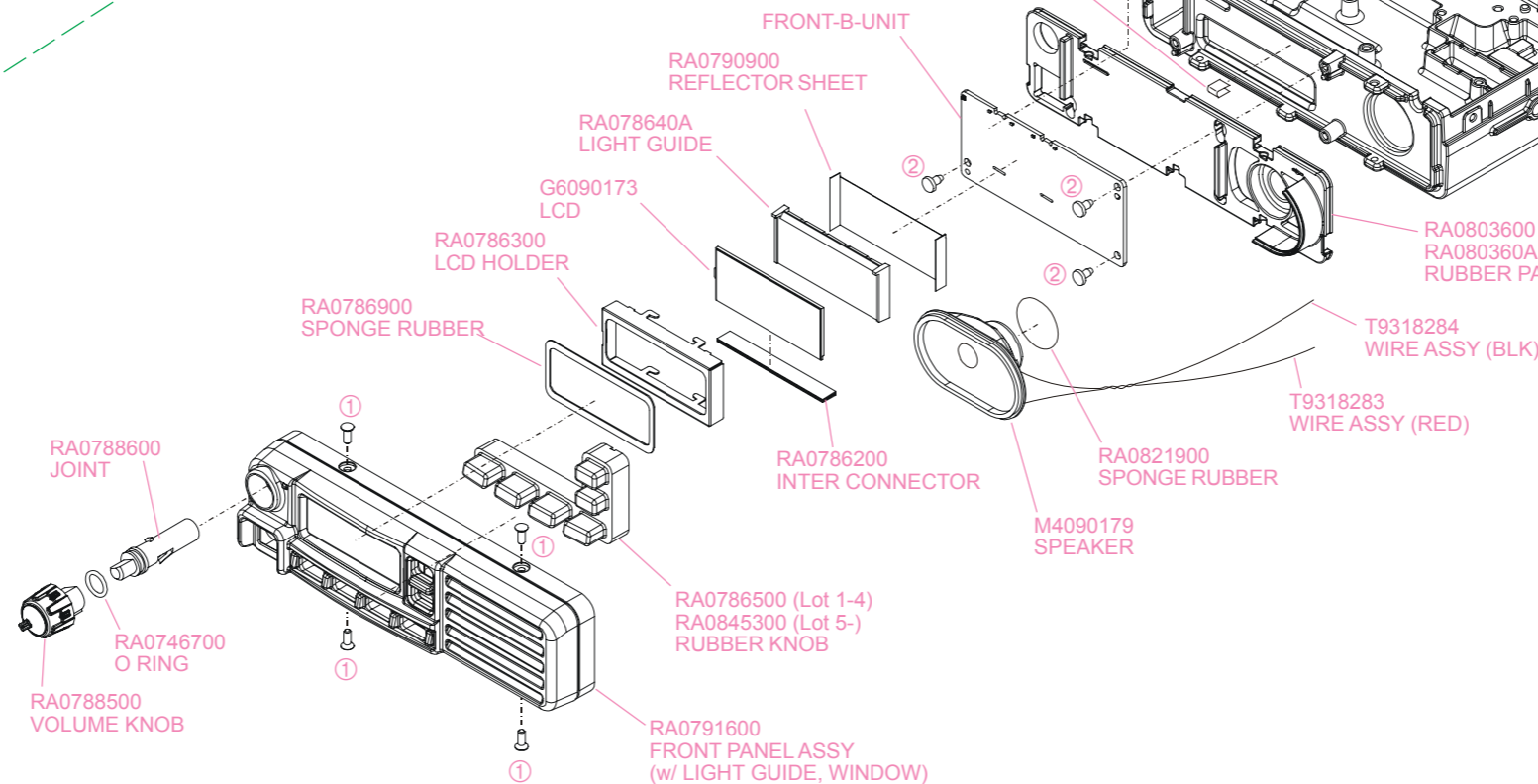

Non-designated parts are available only as part of a designated assembly.

SUPPLIED ACCESSORIES		
VXSTD P/N	DESCRIPTION	QTY.
Q000075	BLADE FUSE ATC 15A (50 W TYPE)	2
Q000112	BLADE FUSE ATC 10A (25 W TYPE)	2
AAE60X001	MICROPHONE MH-67A8J (W/ CLIP)	1
T9021015	DC CABLE (50 W TYPE)	1
T9021010	DC CABLE (25 W TYPE)	1
RA079050A	MOBILE BRACKET	1
RA0796600	KNOB SCREW (for BRACKET)	2
U9900209	HEX HEAD BOLT HSM5X12B	2

No.	VXSTD P/N	DESCRIPTION	QTY.
①	U10206007	TRUSS HEAD SCREW M2.6X6B	10
②	U24308002	TAPTITE SCREW M3X8NI	13
③	U03308002	SEMS SCREW ASM3X8NI	2
④	U24306002	TAPTITE SCREW M3X6NI	2

Exploded View & Miscellaneous Parts

Note:

Block Diagram

Note:

1. Circuit Configuration by Frequency

The receiver is a double-conversion superheterodyne with a first intermediate frequency (IF) of 67.65 MHz and a second IF of 450kHz. The incoming signal from the antenna is mixed with the local signal from the VCO/PLL to produce the first IF of 50.85MHz. This is then mixed with the 67.2 MHz second local oscillator output to produce the 450 kHz second IF. This is detected to give the demodulated signal. The transmit signal frequency is generated by the PLL VCO and modulated by the signal from the microphone. It is then amplified and sent to the antenna.

2. Receiver System

2-1. Front-end RF amplifier

The incoming RF signal from the antenna is delivered to the RF Unit and passes through the Low-pass filter which removes undesired frequencies by use of varactor diodes, tuned band-pass filter consisting of diodes **D1003**, **D1004**, **D1005**, & **D1006** (all **1SV323**), coils L1006 & L1009, and capacitors C1013, C1016, C1033, C1039, C1041, & C1044. The passed signal is amplified in **Q1007** (**2SC3356**) and moreover cuts an image frequency with the band pass filter consisting of coils L1011, L1013, L1014, & L1015, capacitors C1003, C1011, C1012, C1016, C1022, C1023, C1027, C1028, C1334, & C1141 and comes into the 1st mixer.

2-2. First Mixer

The 1st mixer consists of the **Q1025** (**3SK293**). Buffered output from the VCO is amplified by **Q1023** (**2SC5226**) to provide a pure first local signal between 201.65 and 241.65 MHz for injection to the first mixer. The output IF signal enters from the mixer to the crystal filter. The IF signal then passes through monolithic crystal filters XF1001 (± 5.5 kHz BW) to strip away all but the desired signal.

2-3. IF Amplifier

The first IF signal is amplified by **Q1033** (**2SC5226**). The amplified first IF signal is applied to FM IF subsystem IC **Q1036** (**NJM2591**) which contains the second mixer second local oscillator limiter amplifier noise amplifier and S-meter amplifier. The signal from the reference oscillator is tripled by **Q1033** (**2SC5226**), it is mixed with the IF signal and becomes 450 kHz. The second IF then passes through the ceramic filter CF1001 (for wide channels) CF1002 (for narrow channels) to strip away unwanted mixer products which removes amplitude variations in the 450 kHz IF before detection of the speech by the ceramic discriminator CD1001.

2-4. Audio amplifier

Detected signal from **Q1036** (**NJM2591V**) is inputted to **Q1042** (**LM2902PW**) and is output through the band pass filter inside **Q1042** (**LM2902PW**). When the optional unit is installed **Q1044** (**SN74LV4066APW**) is turned "OFF" and the AF signal from **Q1042** (**LM2902PW**) goes the optional unit. When the optional unit is not installed, **Q1042** (**LM2902PW**) is turned "ON" and the signal goes through **Q1004** (**SN74LV4053APM**). The signal then goes through AF mute switch **Q1044** (**SN74LV4066APW**) de-emphasis part **Q1042** (**LM2902PW**), amplified with AF power amplifier **Q1003** (**TDA1519CTH**) after passing AF volume **Q1014** (**M62364FP**). The output of **Q1003** (**TDA1519CTH**) drives a speaker (either the internal or external speaker).

2-5. Squelch Circuit

There are 13 levels of squelch setting from 0 to 12. The level 0 means open the squelch. The level 1 means the threshold setting level and level 11 means tight squelch. From 2 to 10 is established in the middle of threshold and tight. The bigger figure is nearer the tight setting. The level 12 becomes setting of carrier squelch.

2-5-1. Noise Squelch

The noise squelch circuit is composed of the band pass filter of **Q1036** (**NJM2591V**) noise amplifier **Q1047** (**LM2902PW**) and noise detector **D1047** and **D1048** (both **MC2850**). When a carrier isn't received, the noise ingredient which goes out of the demodulator **Q1036** (**NJM2591V**) is amplified in **Q1047** (**LM2902PW**) through the band pass filter **Q1036** (**NJM2591V**) is detected to DC voltage with **D1047**, **D1048** (both **MC2850**) and is inputted to 15 pin (the A/D port) of the **Q1065** (CPU: **LC87F5CC8A**). When a carrier is received the DC voltage becomes "LOW" because the noise is compressed. When the detected voltage to CPU is "HIGH," the CPU stops AF output with **Q1044** (**SN74LV4053**) "OFF" by making pin 80 low. When the detection voltage is low the CPU makes **Q1068** "ON" making pin 80 "H" enabling AF output.

2-5-2. Carrier Squelch

The Pin 14 (A/D port) of **Q1065** (CPU: **LC87F5CC8A**) detects RSSI voltage output from pin 12 of **Q1036** (**NJM2591V**), and controls AF output. The RSSI output voltage changes according to the signal strength of carrier. The stronger signal makes the RSSI voltage higher. The process of the AF signal control is the same as Noise Squelch. The shipping data is adjusted 3dB higher than squelch tight sensitivity.

Circuit Description

3. Transmitter System

3-1. Mic Amplifier

There are two microphone inputs, J1004 (front) and J1006 (D-Sub). Each microphone inputs has its own amplifier. Which microphone is selected is controlled by the CPU and in addition, the amplified AF signal is selected with Flat-AF selection switch **Q1043 (LM2902PW)**. Mic Gain is adjusted with Mic gain VR **Q1014 (M62364PF)** through HPF-AMP **Q1043 (LM2902PW)**, and Pre Emphasis and Mic Mute **Q1044 (SN74LV4066)** are passed at FLAT-AF OFF. And, the option use is selected with OPT selection switch **Q1044 (SN74LV4066)** by the control from CPU. The selected signal enters maximum deviation adjustment volume **Q1014 (M62364FP)** after it goes out of Buffer Amp **Q1043 (LM2902PW)** through limiter and splatter filter of **Q1040 (LM2902PW)**. The adjusted low frequency signal ingredient is amplified by **Q1047 (LM2902PW)** added modulation terminal of TCXO (**X1002**) the FM modulation is made by reference oscillator. The high frequency signal ingredient is amplified **Q1043 (LM2902PW)**, and the level is adjusted by volume control **Q1014 (M62364FP)** to make frequency balance between low frequency. After that, the signal is delivered to the transmit carrier by modulator **D1023 (HVC383B)**.

3-2. Drive and Final amplifier

The modulated signal from the VCO **Q1031 (2SC3356)** is buffered by **Q1027 (2SC5226)** and amplified by **Q1015 (2SC3357)**. The low-level transmit signal is then applied to the Power Module **Q1009 (S-AV32)** for final amplification up to 50 watts output power or **Q1009 (S-AV33A)** for final amplification up to 25 watts output power. The transmit signal then passes through a low-pass filter to suppress harmonic spurious radiation before delivery to the antenna.

3-3. Automatic Transmit Power Control

The output power of Power Module is detected by CM coupler, and is detected by **D1008** and **D1038** (both **HSM88AS**) and is inputted to comparator **Q1048 (LM2902PW)**. The comparator compares two different voltages and makes output power stable by controlling the bias voltage of the power module. There are 3 levels of output power (High, Low-Hi, and Low-Middle for 50 W model) or 4 levels of output power (High, Low-Hi, Low-Middle, and E-Low for 25 W model) which is switched by the voltage of **Q1014-CH1 (M62364FP)**.

3-4. PLL Frequency Synthesizer

The frequency synthesizer consists of PLL IC **Q1054 (ADF411BRU)** VCO, TCXO (**X1002**) and buffer amplifier. The output frequency from TCXO is 16.8 MHz and the tolerance is ± 2.5 ppm (in the temperature range -30 to $+60$ degrees).

3-4-1. VCO

While the radio is receiving, the RX oscillator **Q1029 (2SK508)** in the VCO generates a programmed frequency between 201.65 and 241.65 MHz as 1st local signal. While the radio is transmitting the TX oscillator **Q1031 (2SC3356)** in the VCO generates a frequency between 134 and 174 MHz. The output from oscillator is amplified by buffer amplifier **Q1027 (2SC5226)** and becomes the output of the VCO. The output from VCO is divided one is amplified by **Q1024 (2SC5226)** and feed back to pin 6 of the PLL IC **Q1054 (TRF3750IP)**. The other is amplified in **Q1023 (2SC5226)** and in case of the reception it is put into the mixer as the 1st local signal through **D1020 (DAN222)** in transmission it is amplified in **Q1027 (2SC5226)** and more amplified in **Q1023 (2SC5226)** through **D1022 (DA222)** and it is put the input terminal of the Power Module **Q1009 (S-AV32)** for 50 W model or **S-AV33A** for 25 W model).

3-4-2. VCV CNTRL

Tuning voltage (VCV) of the VCO expands the lock range of VCO by controlling the of varactor diode voltage and the control voltage from PLL IC **Q1054 (ADF411BRU)**. Control voltage is added to the varactor diode after converted to D/A converter **Q1029 (M62364FP)**.

3-4-3. PLL

The PLL IC **Q1054 (ADF411BRU)** consists of reference divider, main divider, phase detector, charge pumps and Pulse Swallow Frequency Synthesis. The reference frequency from TCXO is inputted to pin 8 of PLL IC **Q1054 (ADF411BRU)** and is divided by reference divider. This IC is decimal point dividing PLL IC **Q1054 (ADF411BRU)** and the dividing ratio becomes 1/8 of usual PLL frequency step. Therefore, the output of reference divider is 8 times of frequencies of the channel step. For example when the channel stepping is 5 kHz, the output of reference divider becomes 40 kHz. On the other hand, inputted feed back signal to pin 6 of PLL IC **Q1054 (ADF411BRU)** from VCO is divided with the dividing ratio which becomes same frequency as the output of reference divider. These two signals are compared by phase detector, a phase pulse is generated. The phase difference pulse and the pulse from fractional accumulator pass through the charge pumps and LPF. This becomes the DC voltage (VCV) to control the VCO. The oscillation frequency of VCO is locked by the control of this DC voltage. The PLL serial data from CPU **Q1065** (CPU: **LC87F5CC8A**) is sent with three lines of SDO (pin 12), SCK (pin 11) and PSTB (pin 13). The lock condition of PLL is output from the UL (pin 14) terminal and UL becomes "H" at the time of the lock condition and becomes "L" at the time of the unlocked condition. The CPU **Q1065** (CPU: **LC87F5CC8A**) always watches over the UL condition, and when it becomes "L" unlocked condition, the CPU **Q1065** (CPU: **LC87F5CC8A**) prohibits transmitting and receiving.

Introduction

The **VX-2100/-2200** series has been aligned at the factory for the specified performance across the entire frequency range specified. Realignment should therefore not be necessary except in the event of a component failure. All component replacement and service should be performed only by an authorized Vertex Standard representative, or the warranty policy may be voided.

The following procedures cover the sometimes critical and tedious adjustments that are not normally required once the transceiver has left the factory. However, if damage occurs and some parts are replaced, realignment may be required. If a sudden problem occurs during normal operation, it is likely due to component failure; realignment should not be done until after the faulty component has been replaced.

We recommend that servicing be performed only by authorized Vertex Standard service technicians who are experienced with the circuitry and fully equipped for repair and alignment. Therefore, if a fault is suspected, contact the dealer from whom the transceiver was purchased for instructions regarding repair. Authorized Vertex Standard service technicians realign all circuits and make complete performance checks to ensure compliance with factory specifications after replacing any faulty components. Those who do undertake any of the following alignments are cautioned to proceed at their own risk. Problems caused by unauthorized attempts at realignment are not covered by the warranty policy. Also, Vertex Standard must reserve the right to change circuits and alignment procedures in the interest of improved performance, without notifying owners. Under no circumstances should any alignment be attempted unless the normal function and operation of the transceiver are clearly understood, the cause of the malfunction has been clearly pinpointed and any faulty components replaced, and the need for realignment determined to be absolutely necessary. The following test equipment (and thorough familiarity with its correct use) is necessary for complete realignment. Correction of problems caused by misalignment resulting from use of improper test equipment is not covered under the warranty policy. While most steps do not require all of the equipment listed, the interactions of some adjustments may require that more complex adjustments be performed afterwards. Do not attempt to perform only a single step unless it is clearly isolated electrically from all other steps. Have all test equipment ready before beginning, and follow all of the steps in a section in the order presented.

Required Test Equipment

- Radio Tester with calibrated output level at 200 MHz
- In-line Wattmeter with 5% accuracy at 200 MHz
- 50-ohm, 50-W RF Dummy Load
- Regulated DC Power Supply (standard 13.6V DC, 15A)
- Frequency Counter: ± 0.2 ppm accuracy at 200 MHz
- AF Signal Generator
- AC Voltmeter
- DC Voltmeter
- VHF Sampling Coupler
- Microsoft® Windows® 95 or later operating system
- Vertex Standard VPL-1 Connection Cable and CE82 Alignment program

Alignment Preparation & Precautions

A 50-ohm RF Dummy load and in-line wattmeter must be connected to the main antenna jack in all procedures that call for transmission, except where specified otherwise. Correct alignment is not possible with an antenna.

Because of the BTL (Bridged TransLess) Amplifier circuit used in the **VX-2200/-2100**, do not connect either side of the speaker leads to chassis "ground."

After completing one step, read the following step to determine whether the same test equipment will be required. If not, remove the test equipment (except dummy load and wattmeter, if connected) before proceeding.

Correct alignment requires that the ambient temperature be the same as that of the transceiver and test equipment, and that this temperature be held constant between 20 °C and 30 °C (68 °F ~ 86 °F). When the transceiver is brought into the shop from hot or cold air, it should be allowed time to come to room temperature before alignment.

Whenever possible, alignments should be made with oscillator shields and circuit boards firmly affixed in place. Also, the test equipment must be thoroughly warmed up before beginning.

Note: Signal levels in dB referred to in this procedure are based on 0 dB μ EMF = 1.0 μ V.

Alignment

Test Setup

Setup the test equipment as shown for transceiver alignment, apply 13.6V DC power to the transceiver. Refer to the drawings above for Alignment Points.

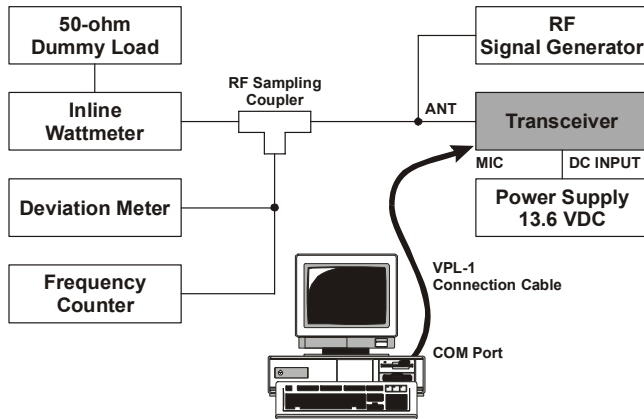

The Alignment Tool Outline

Installation the tool

Install the CE82 (Clone Editor) to your PC.

The re-alignment for VX-2200/-2100 series may use the "Alignment" menu of CE82.

Action of the switches

When the transceiver is in alignment mode, the action of PTT and KEY is ignored. All of the action is remote controlled by PC.

Basic Alignment Mode

The Basic Alignment mode allows you to align the entire radio. The value of each parameter can be changed to the desired position by use of the "←" / "→" and up/down arrow keys, along with direct number input and dragging of the PC mouse.

To enter the Basic Alignment Mode, select "Basic Alignment" in the main "Radio" menu. It will start to "Upload" the written personalized data from the radio. Pressing the "OK" button will then start the Basic Alignment Mode.

Note: when all items are to be aligned, it is strongly rec-

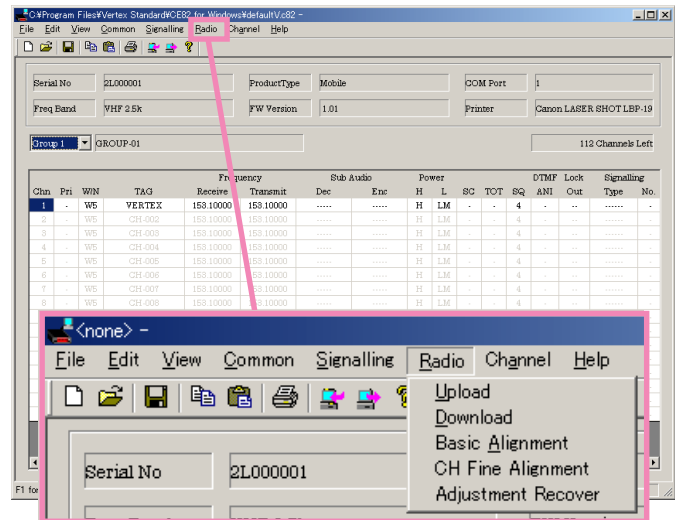

ommended to align them according to following sequence. When the item is selected with TAB key, and the F1 key is pushed, the "Help" file is displayed. Detailed information for each step may be found in the "Help" file within CE82 (Clone Editor).

1. RX VCO Tune Voltage (RX VCO)
2. TX VCO Tune Voltage (TX VCO)
3. PLL Reference Frequency (Frequency)
4. RX Sensitivity (RX Tune)
5. Squelch (SQL)
6. TX Power
7. Maximum Deviation <Wide> / <Narrow>
8. Sub Audio Deviation <CTCSS> / <DCS>
9. Sequential Tone Deviation

Unit

During alignment, the values of dB μ V or μ V (EMF or PD) can be selected or dBm.

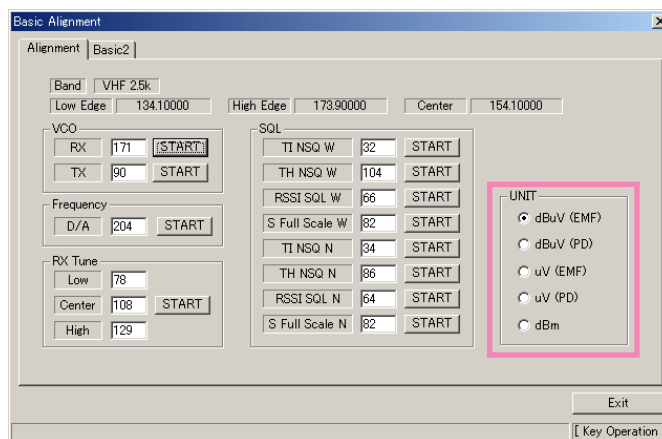

1. RX VCO Tune Voltage (RX VCO)

This parameter is to align the "Tune Voltage" of RX VCO. This alignment will be done automatically between the radio and PC.

1. Press the "Start" button on the "Basic Alignment" window to open the RX VCO Adjustment window.
2. Press the "Start" button to start the alignment then the "OK" and "Cancel" buttons are inhibited during the alignment.
3. The aligned value will appear and the "OK", "Cancel" buttons come alive when auto-alignment is finished.
4. Press the "OK" button on the window, the value of the alignment for RX VCO will be saved in the radio.

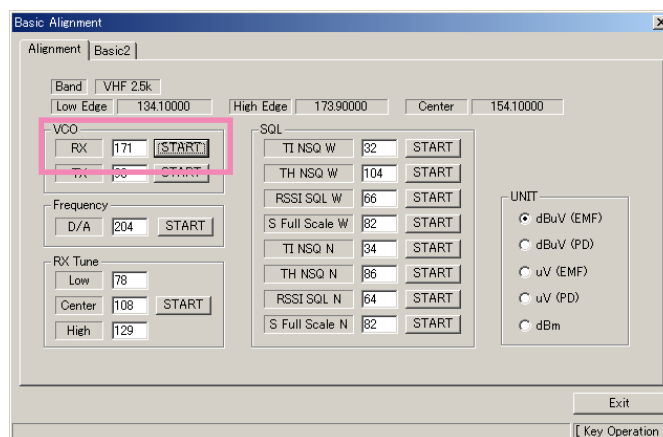

2. TX VCO Tune Voltage (TX VCO)

This parameter is to align the "Tune Voltage" of TX VCO. This alignment will be done automatically between the radio and PC.

1. Press the "Start" button on the "Basic Alignment" window to open the TX VCO Adjustment window.
2. Press the "Start" button to start the alignment then the "OK" and "Cancel" buttons are inhibited during the alignment.
3. The aligned value will appear and the "OK", "Cancel" buttons come alive when auto-alignment is finished.
4. Press the "OK" button on the window, the value of the alignment for TX VCO will be saved in the radio.

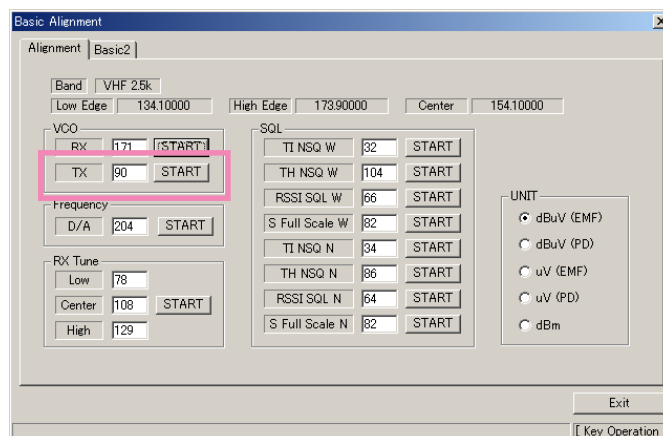

Alignment

3. PLL Reference Frequency (Frequency)

This parameter is to align the reference frequency for PLL. The “TX VCO Tune Voltage” alignment must be done before this alignment is going to start.

1. Press the “Start” button to start the alignment then the radio will transmit on the center frequency. It will appear the Frequency Alignment window.
2. Set the value to get desired frequency by left/right arrow key, drag the slide bar by mouse or direct number input.
3. Press the “OK” button on the alignment window to save the re-aligned value, the alignment of the PLL Reference Frequency is accomplished.

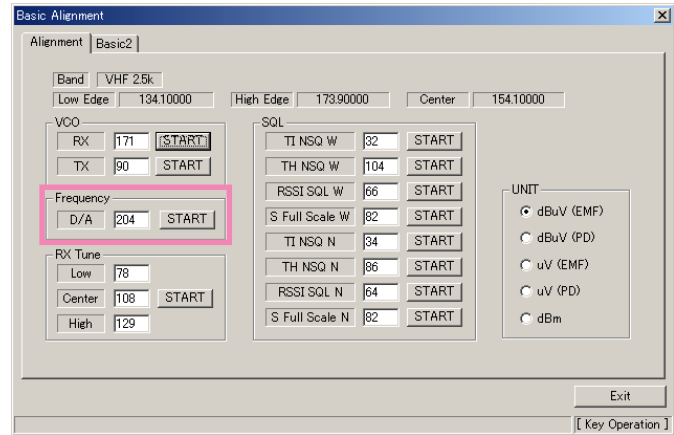

4. RX Sensitivity (RX Tune)

This parameter is to align the RX BPF (Band Pass Filter) for Rx sensitivity. It must be done both alignments of the “RX VCO Tune Voltage” and “PLL Reference Frequency” before this alignment is going to start.

1. Press the “Start” button to start the alignment.
2. Set the Signal Generator according to the indication, then press “OK”.
3. Repeat the procedure no.2 until the 3point alignment is finished.
4. It will show the result of 3 points alignment and press “OK” then the confirmation window will open.
5. Press “OK” to finish the RX Sensitivity alignment and save the data.

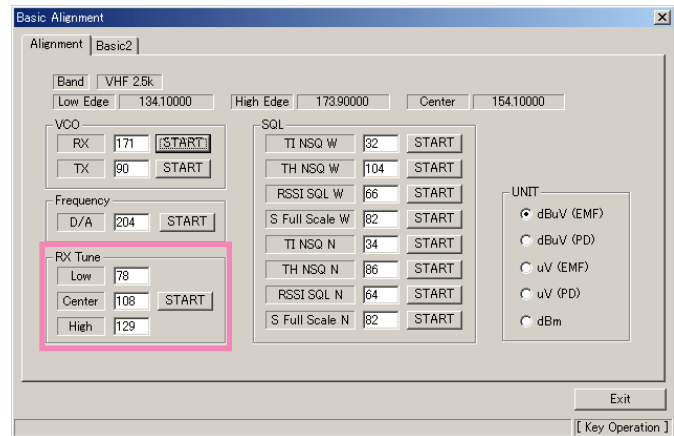

5. Squelch (SQL)

This parameter is to align the SQL (Squelch) Sensitivity. The “RX VCO Tune Voltage”, “PLL Reference Frequency” and “RX Sensitivity (RX Tune)” must be done before this alignment is started.

There are several alignments as follows in the Squelch Sensitivity.

Noise SQL Tight <Wide> (TH NSQ W)

The Alignment for the Noise SQL Tight level at Wide (5k/4k).

Noise SQL Threshold <Wide> (TH NSQ W)

The Alignment for the Noise SQL Threshold level at Wide (5k/4k).

RSSI SQL Level 11 <Wide> (RSSI SQL W)

The Alignment for the “level 11” of the RSSI SQL level at Wide (5k/4k).

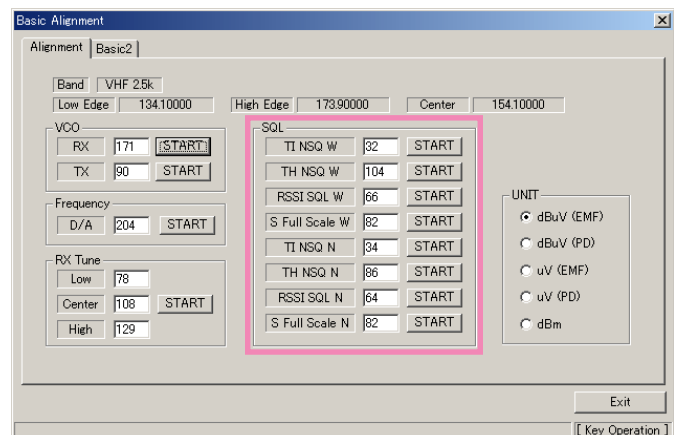

RSSI SQL Full Scale <Wide> (S Full Scale W)

The Alignment for the RSSI Full Scale level at Wide (5k/4k).

Noise SQL Tight <Narrow> (TI NSQ N)

The Alignment for the Noise SQL Tight level at Narrow (2.5k).

Noise SQL Threshold <Narrow> (TH NSQ N)

The Alignment for the Noise SQL Threshold level at Narrow (2.5k).

RSSI SQL Level 11 <Narrow> (RSSI SQL N)

The Alignment for the “level 11” of the RSSI SQL level at Narrow (2.5k).

RSSI SQL Full Scale <Narrow> (S Full Scale N)

The Alignment for the RSSI Full Scale level at Narrow (2.5k).

The procedure for all the alignment is as follows.

1. Press the “Start” button to start the alignment.
2. Set the signal generator according to the level indicated, then press “OK”.
3. Press the “OK” button after finish the alignment, then the data will be saved and the alignment is accomplished.

6. TX Power

Open the “Basic2” window, this parameter is to align the Transmit Output (Hi/Low) Power. The factory default is as followings.

	50 W model	25 W model
High	50 W	25 W
Low-High	25 W	12.5 W
Low-Middle	10 W	5 W
E-Low	—	1 W

The procedure for the alignments of the TX Power is followings.

1. Press the “Start” button to start the alignment then the radio will transmit on the center frequency. The TX Power Alignment window will open on the PC.
2. Set the value to get desired output power by left/right arrow key, drag the slide bar by mouse or direct number input.
3. Press the “OK” button on the alignment window to save the re-aligned value, the alignment of the TX POWER is accomplished.

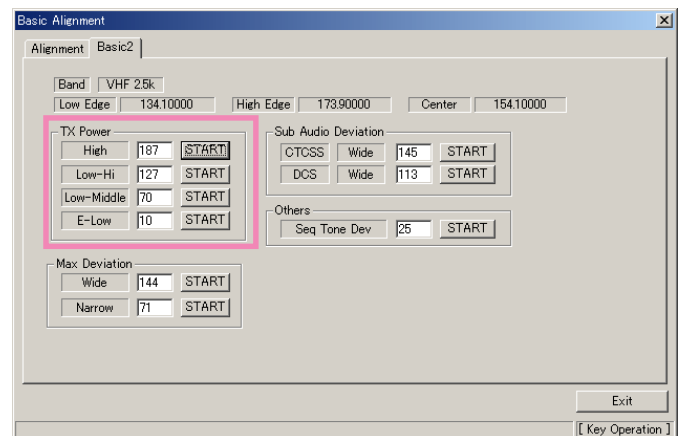

Alignment

7. Maximum Deviation <Wide> / <Narrow>

This parameter is to align the Maximum Deviation (Wide/Narrow). The “TX VCO Tune Voltage” must be done before this alignment is started.

1. Press the “Start” button to start the alignment.
2. Set the value to get desired deviation (Wide: 4.2kHz, Narrow: 2.1kHz) on the deviation meter by changing the slide bar on your PC.
3. Press the “OK” button after getting the desired Deviation to save the re-aligned value, the alignment of the MAX DEVIATION is accomplished.

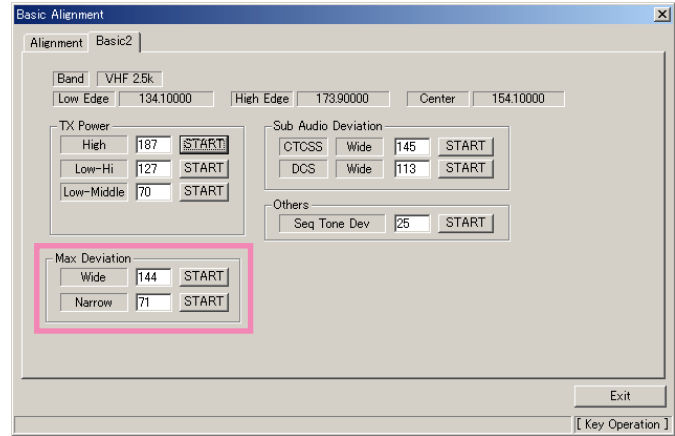

8. Sub Audio Deviation <CTCSS> / <DCS>

This parameter is to align the Deviation of Sub-Audio (CTCSS/DCS). The “TX VCO Tune Voltage” and “Max Deviation” must be done before this alignment is started.

1. Press the “Start” button to start the alignment.
2. Set the value to get desired deviation (Wide: 0.6kHz) on the deviation meter by changing the slide bar on your PC.
3. Press the “OK” button after getting the desired value to save the re-aligned value, the alignment of the MAX DEVIATION is accomplished.

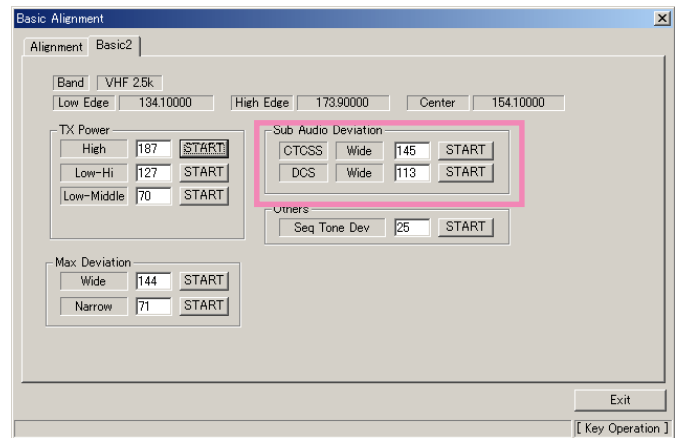

9. Sequential Tone Deviation

This parameter is to align the “Sequential Tone Deviation” (for 2-Tone, 5-Tone and DTMF sequential tones).

1. Press the “Start” button to start the alignment.
2. Set the value to get desired deviation by changing the slide bar on your PC.
3. Press the “OK” button after getting the desired value to save the re-aligned value, the alignment of the SEQUENTIAL TONE DEVIATION is accomplished.

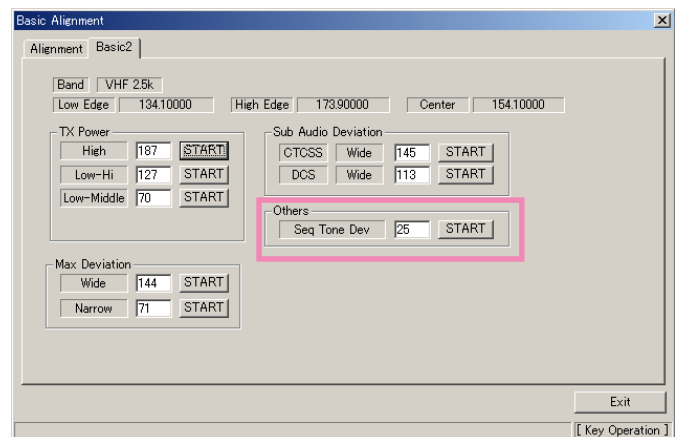

CH (Channel-by-Channel) Fine Alignment Mode

The CH Fine Alignment Mode allows you to align the radio separately for every operating channel. The value of each parameter can be changed to the desired position using the “←” / “→” and up/down arrow keys, direct number input, and by dragging the PC mouse.

To enter the CH Fine Alignment Mode, select “CH Fine Alignment” in the main “Radio” menu. It will start to “Upload” the written personalized data from the radio. Pressing the “OK” button will then start the CH Fine Alignment Mode.

Note: Detailed information for each step may be found in the “Help” file within CE82 (Clone Editor).

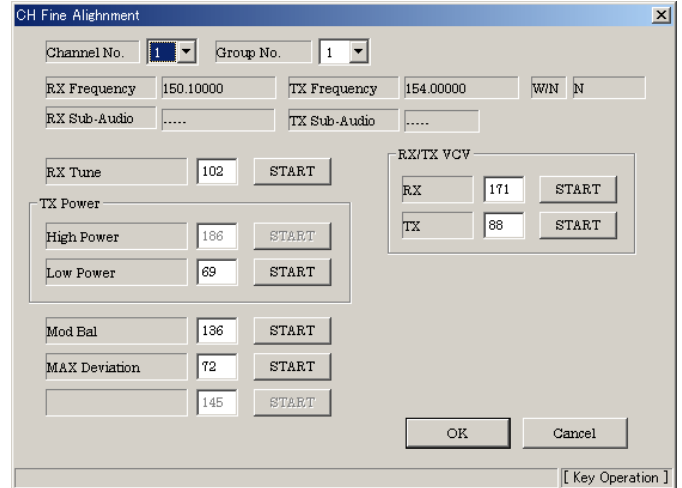

Installation of Option

FVP-25/FVP-35/FVP-36

The **FVP-25** is an Encryption/DTMF Paging Unit which permits secure voice communications with station within your network, while preventing others from listening using normal communications equipment. It allows paging, and enables selective calling using DTMF tone sequences.

The **FVP-35** is an Rolling Code Encryption Unit which permits secure voice communications with station within your network, while preventing others from listening using normal communications equipment.

The **FVP-36** is an Voice Inversion Type Encryption Unit which permits secure voice communications with station within your network, while preventing others from listening using normal communications equipment.

Each optional Unit is easily programmed the configurations using a Vertex CE82 programmer with an IBM PC-compatible computer.

1. Disconnect the DC power cable.
2. Referring to Figure 1, remove the 8 screws affixing the Top Cover, then remove the top cover.
3. Referring to Figure 2 & Figure 3, locate the empty connector for the Optional Unit, connect the Optional Unit here.
4. Replace the Top Cover and 8 screws . Installation is now complete.

Do not install all Optional Unit at once

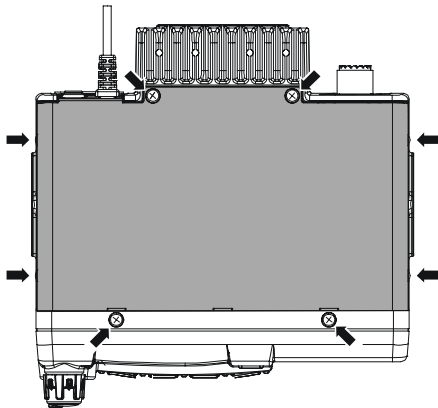

Figure 1

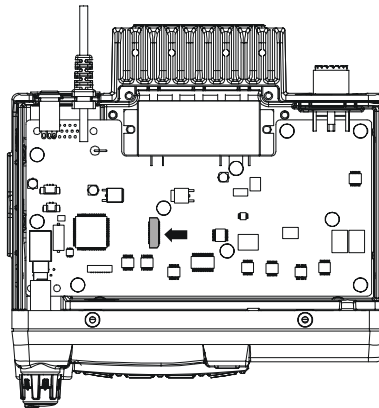

Figure 2

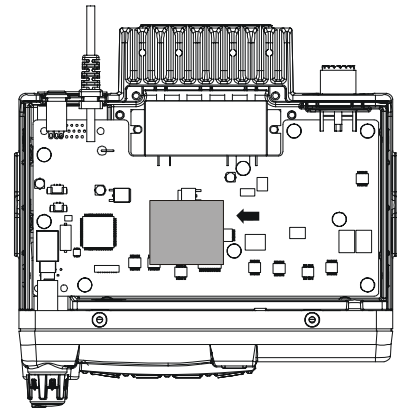
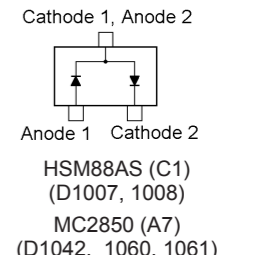
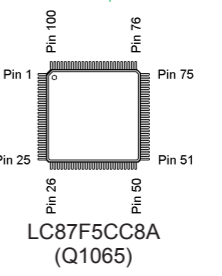
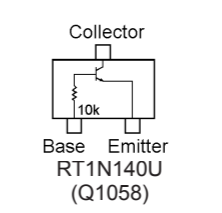
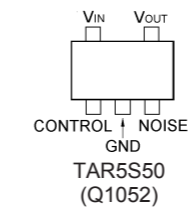
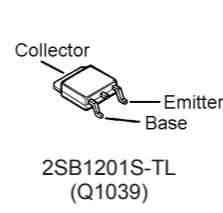
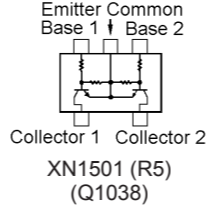
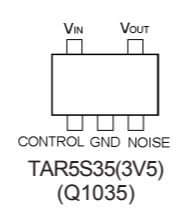
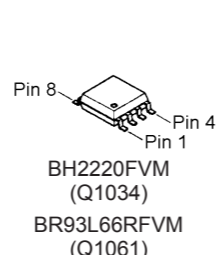
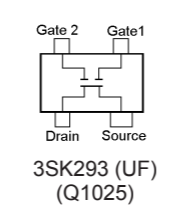
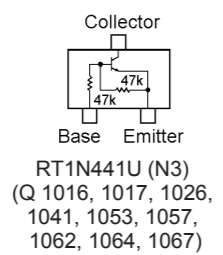
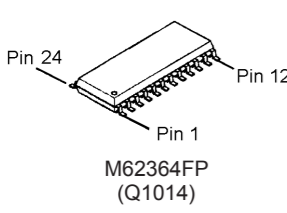
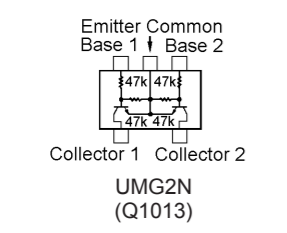
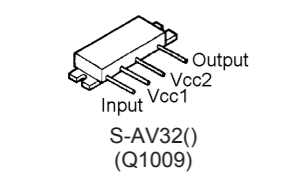
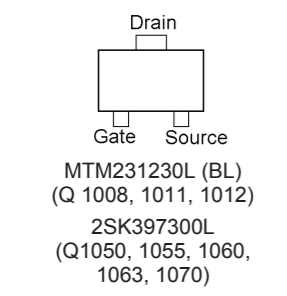
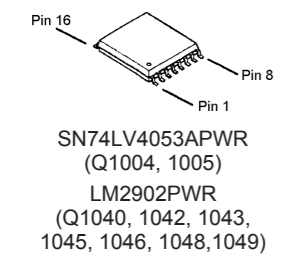
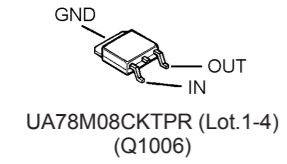
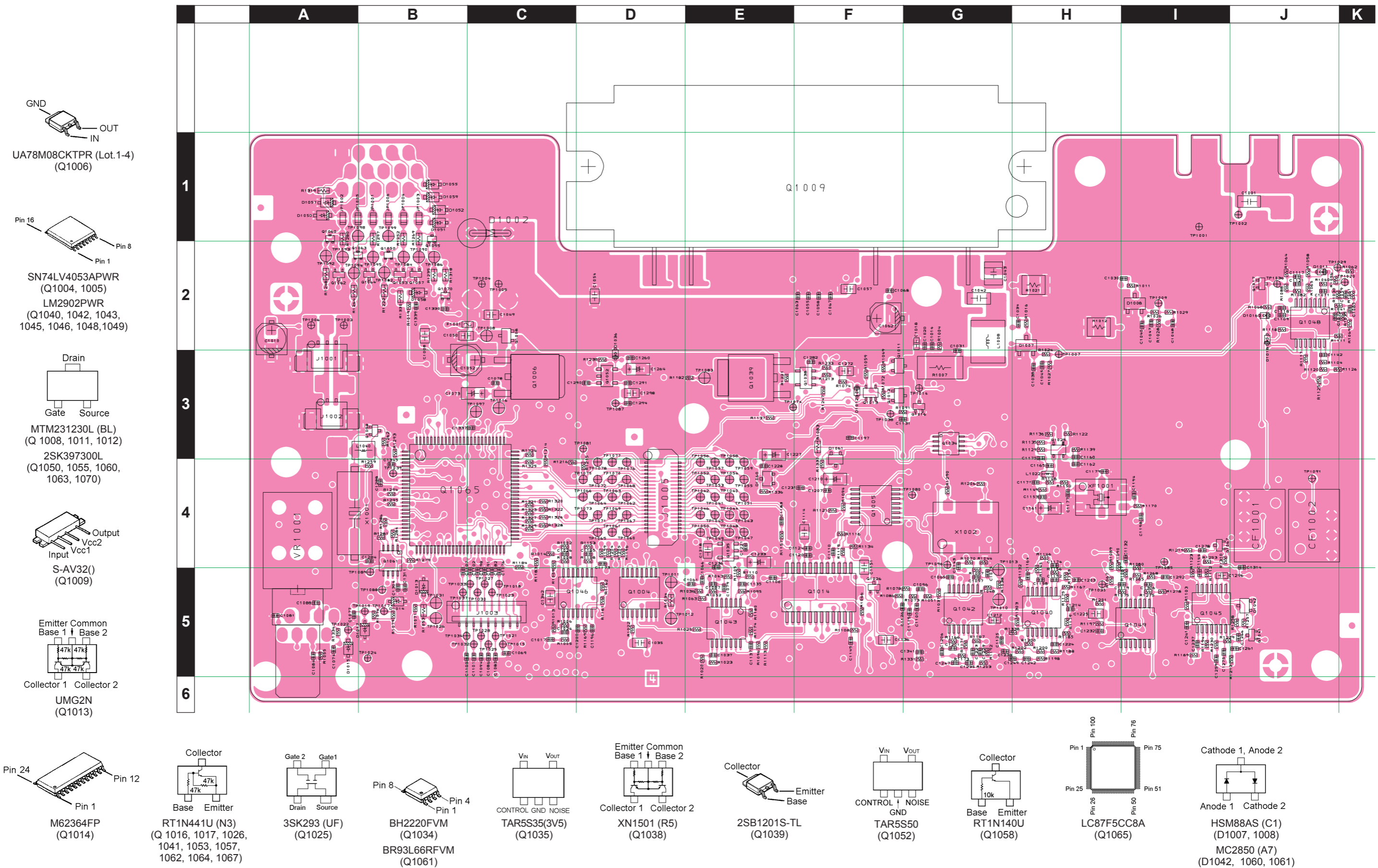

Figure 3

MAIN Unit (Lot. 1~4)

Note



MAIN Unit (Lot. 1~4)

Parts Layout (Side B)

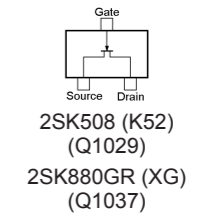
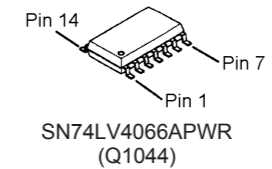
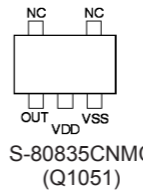
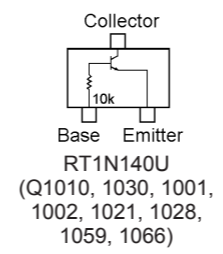
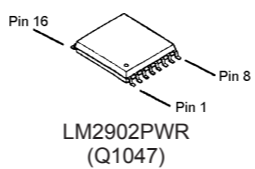
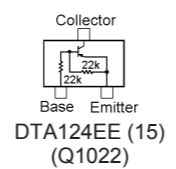
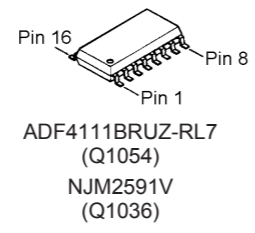
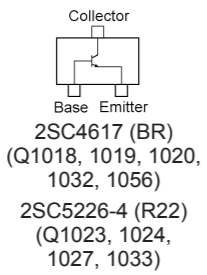
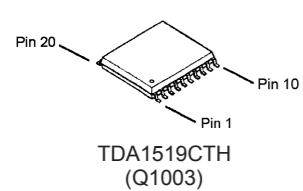
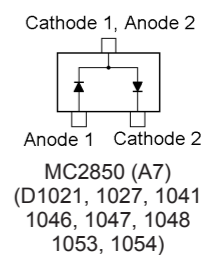
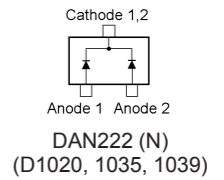
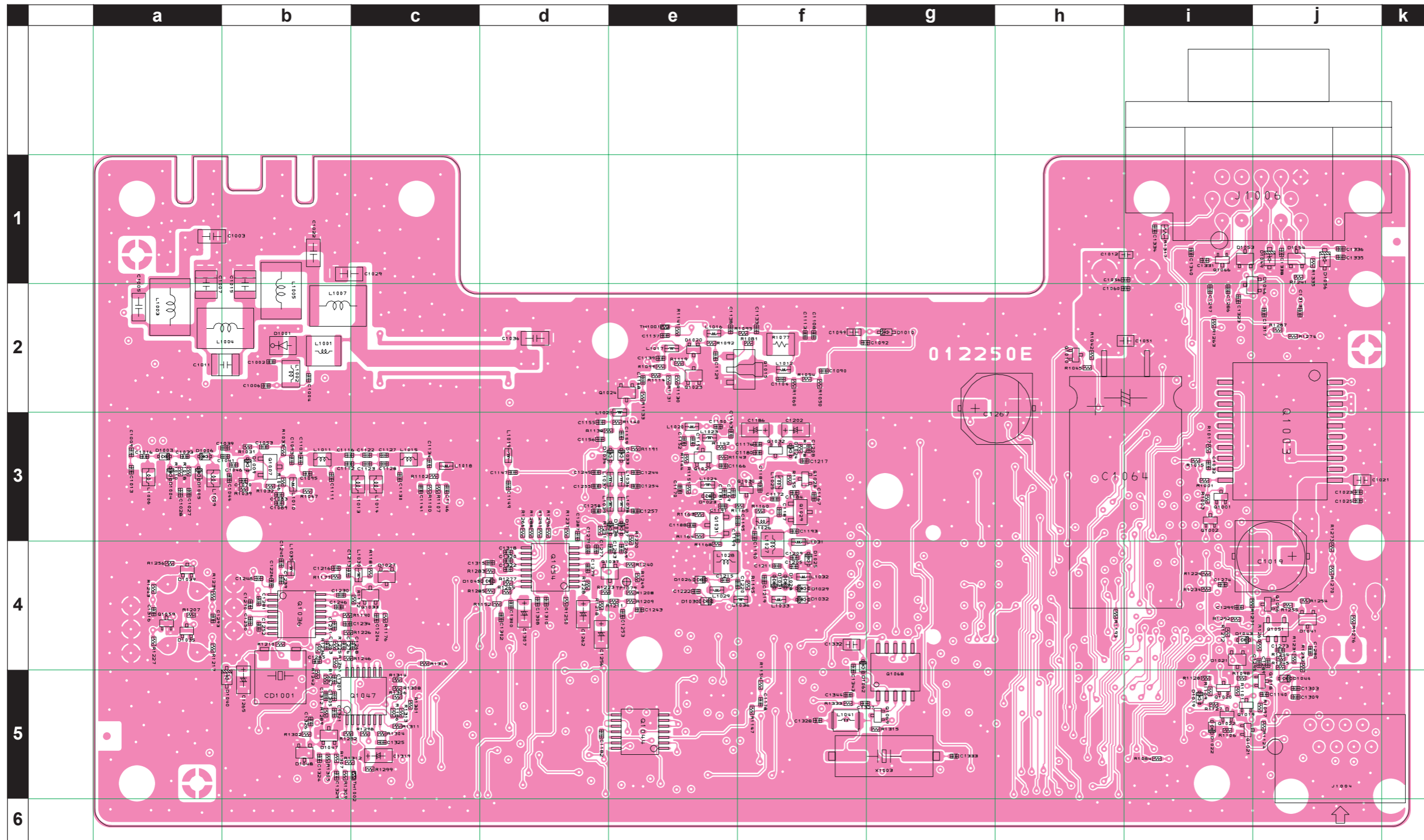

MAIN Unit (Lot. 5~8)

Note

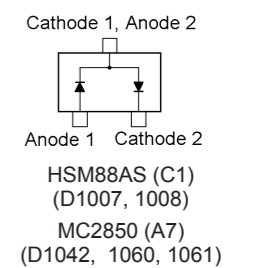
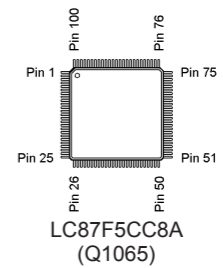
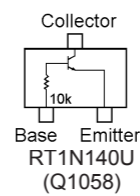
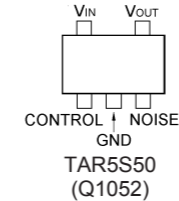
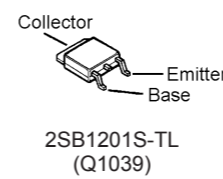
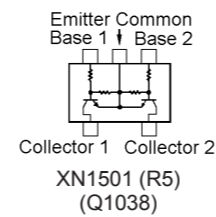
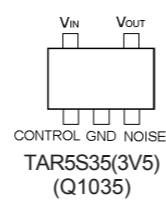
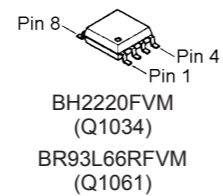
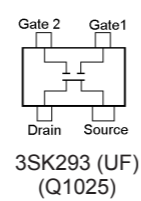
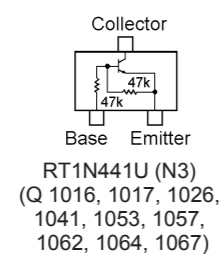
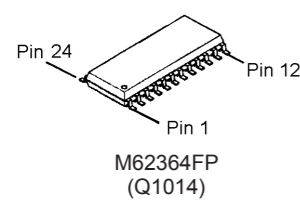
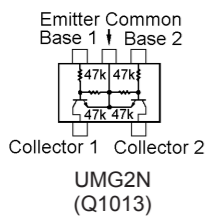
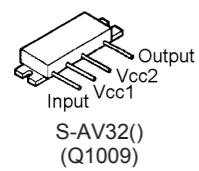
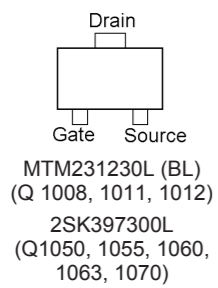
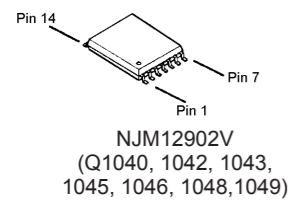
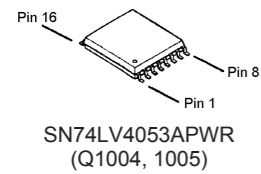
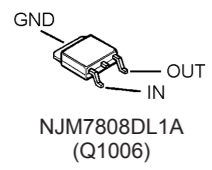
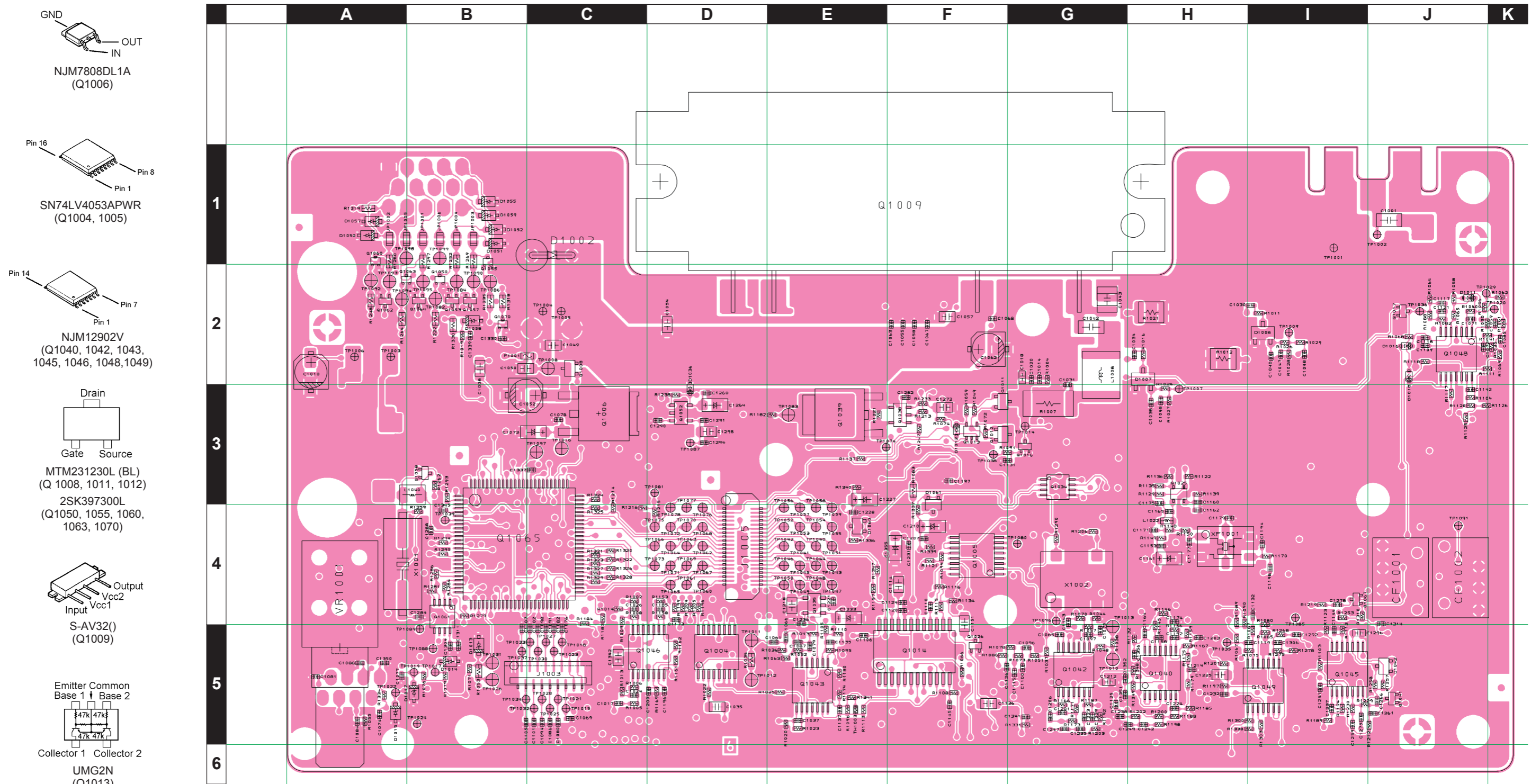

MAIN Unit (Lot. 5~8)

Parts Layout (Side B)

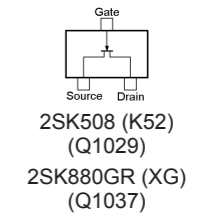
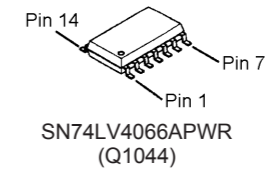
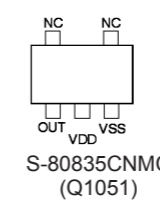
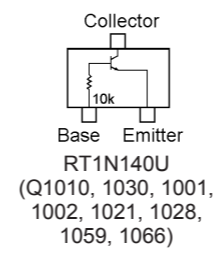
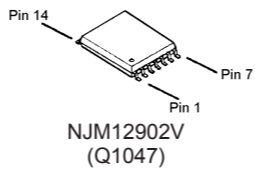
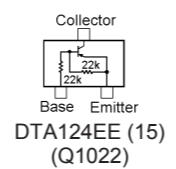
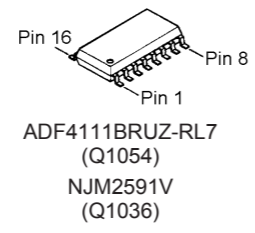
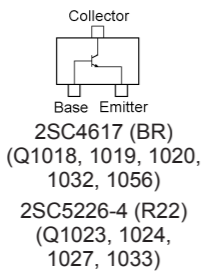
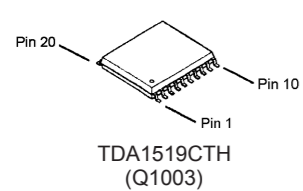
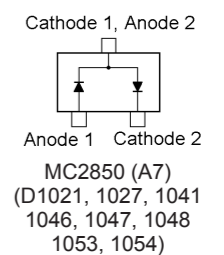
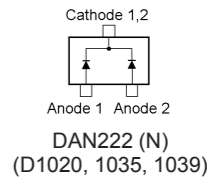
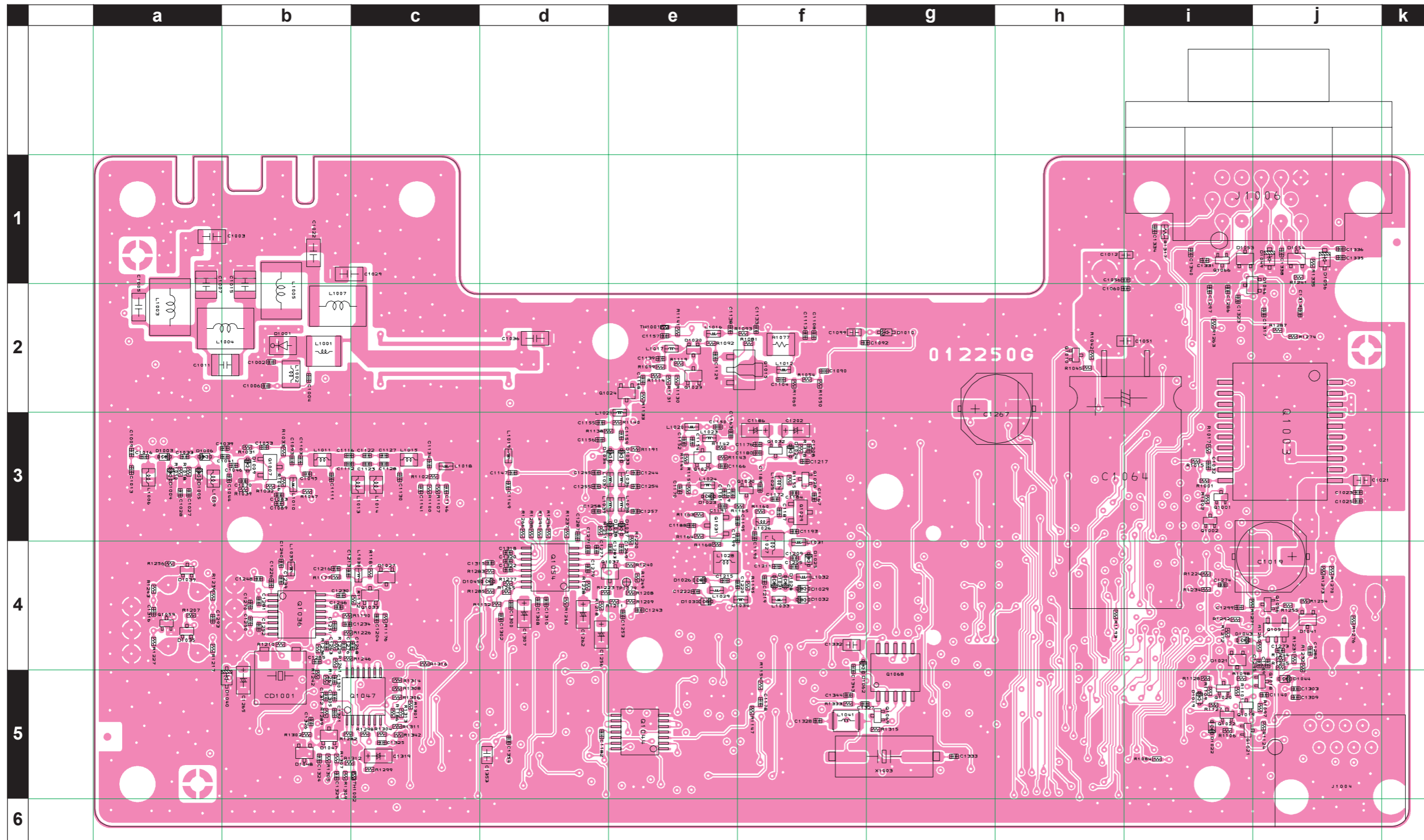

MAIN Unit (Lot. 9~)

Note

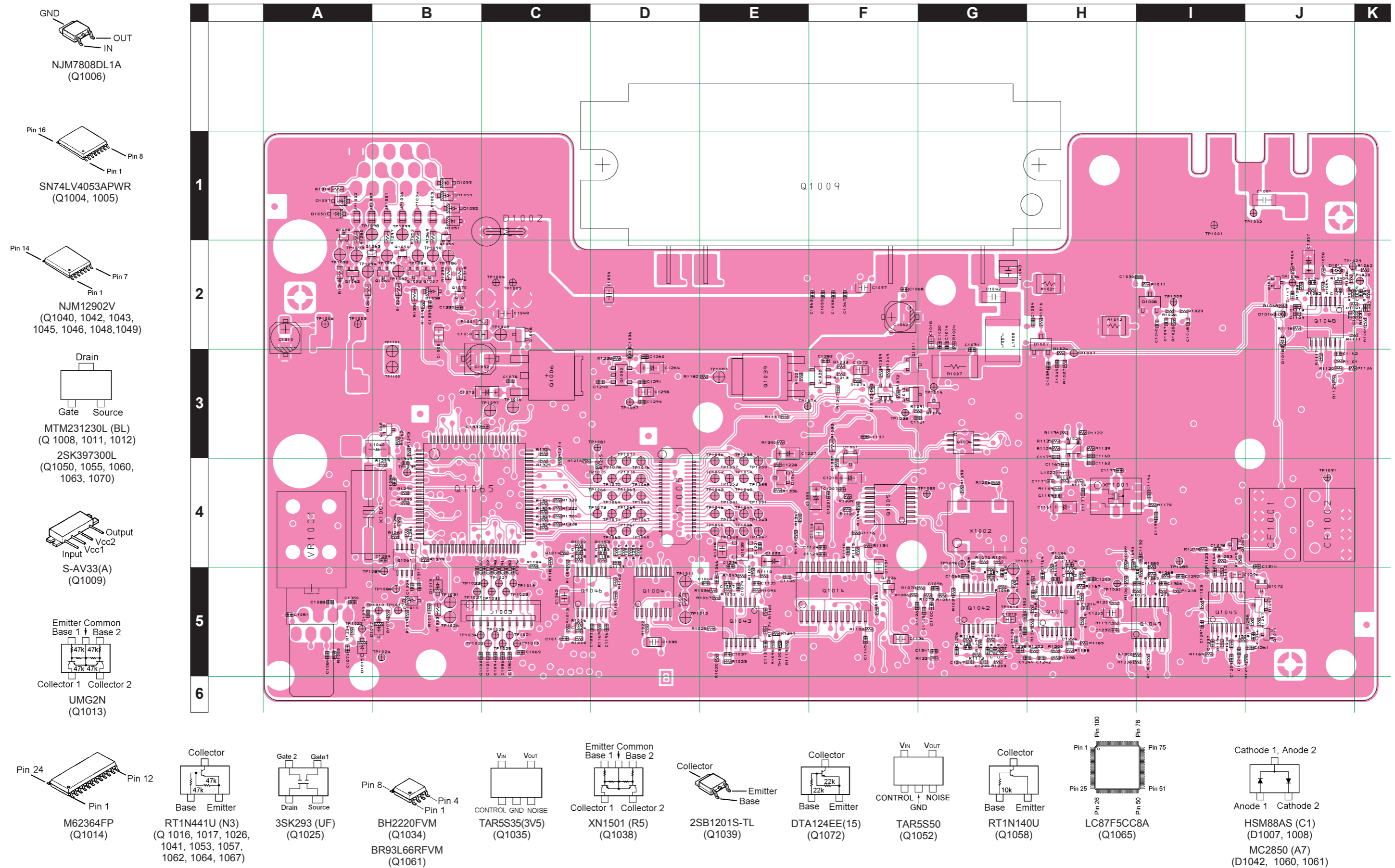

MAIN Unit (Lot. 9~)

Parts Layout (Side B)

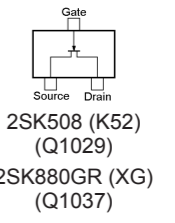
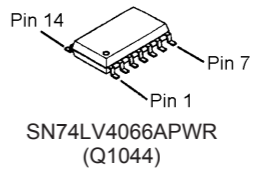
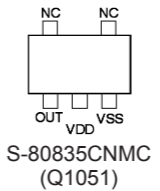
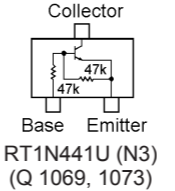
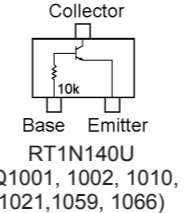
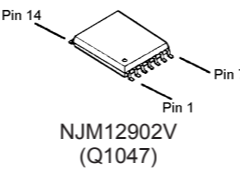
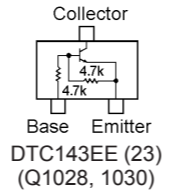
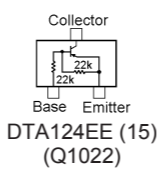
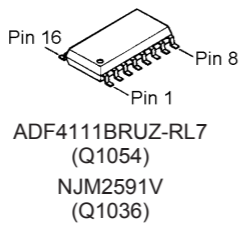
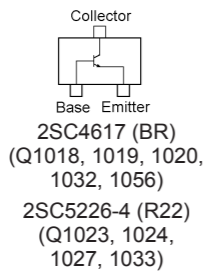
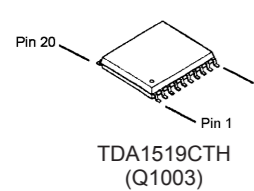
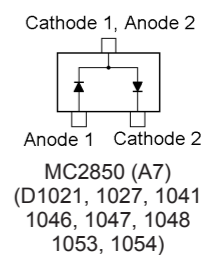
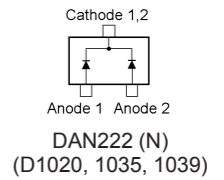
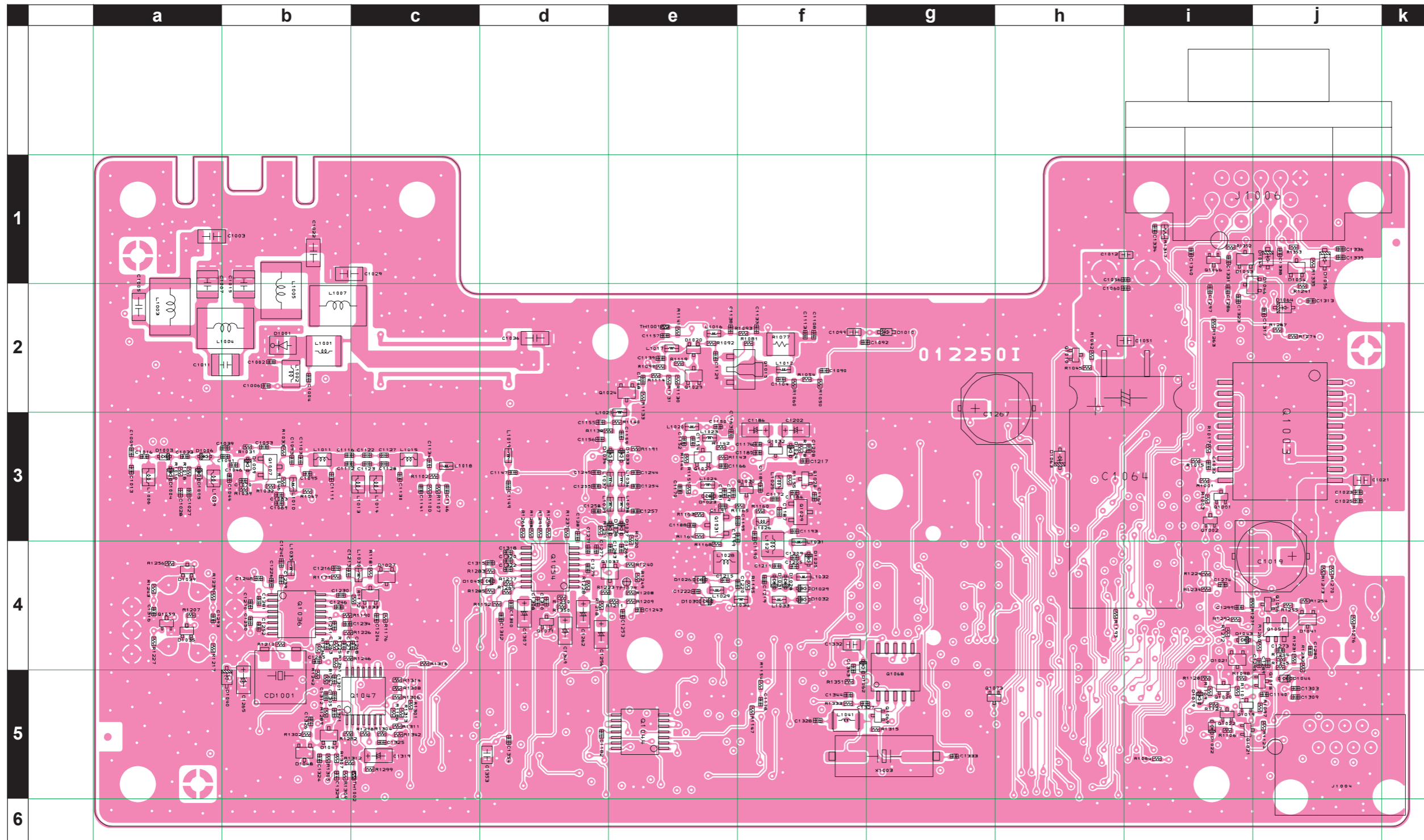

MAIN Unit

Parts List

REF	DESCRIPTION	VALUE	V/W	TOL.	MFR'S DESIG	VXSTD P/N	VERS.	LOT	SIDE	LAY	ADR
PCB with Components						CS1873001	VTX 50 W				
						CS1873002	VTX 25 W				
						CS1873003	EU 25 W				
						CS1873004	EXP 50 W				
						CS1873005	EXP 25 W				
						CS1873007	CHN 50 W				
						CS1873008	CHN 25 W				
Printed Circuit Board						FR012250E		1-			
						FR012250G		5-			
						FR012250I		9-			
C 1001	CERAMIC CAP.	0.001uF	100V	CH	GRM42-6CH102J100PT	K22201202		1-	A		J1
C 1002	CHIP CAP.	18pF	50V	CH	GRM1552C1H180JZ01D	K22178218		1-	B		b2
C 1003	CHIP CAP.	5.6pF	500V	CH	1206N5R6C501LT	K22278206		1-8	B		a1
C 1003	CHIP CAP.	6.8pF	500V	CH	1206N6R8D501LT	K22278207	25W	9-	B		a1
C 1003	CHIP CAP.	5.6pF	500V	CH	1206N5R6C501LT	K22278206	50W	9-	B		a1
C 1005	CHIP CAP.	10pF	500V	CH	CF316CH100D500AT	K22271255		1-	B		a2
C 1006	CHIP CAP.	3pF	50V	CJ	GRM1553C1H3R0BZ01D	K22178290		1-	B		b2
C 1007	FILM CAP.	33pF	500V		UC232H0330G-T	K33279053		1-8	B		a1
C 1007	CHIP CAP.	33pF	500V	CH	GRM42-6CH330J500PT	K22271225	25W	9-	B		a1
C 1007	FILM CAP.	33pF	500V		UC232H0330G-T	K33279053	50W	9-	B		a1
C 1008	CHIP CAP.	10uF	6.3V	B	JMK212BJ106KG-T	K22080802		1-	A		B2
C 1009	CHIP CAP.	0.001uF	50V	B	GRM155B11H102KA01D	K22178809		1-	B		a3
C 1010	AL.ELECTRO.CAP.	10uF	25V		EMVA250ADA100MD55G	K48140014		1-	A		A2
C 1011	FILM CAP.	12pF	500V		UC232H0120J-T	K33279020		1-8	B		b2
C 1011	CHIP CAP.	12pF	500V	CH	1206N120J501LT	K22278210	25W	9-	B		b2
C 1011	FILM CAP.	12pF	500V		UC232H0120J-T	K33279020	50W	9-	B		b2
C 1012	CHIP CAP.	0.01uF	50V	B	GRM188B11H103KA01D	K22174823		1-	B		i1
C 1014	CHIP CAP.	0.001uF	50V	B	GRM155B11H102KA01D	K22178809		1-	A		G2
C 1015	FILM CAP.	33pF	500V		UC232H0330G-T	K33279053		1-8	B		b1
C 1015	CHIP CAP.	27pF	500V	CH	GRM42-6CH270J500PT	K22271223	25W/CE:OFF	9-	B		b1
C 1015	CHIP CAP.	22pF	500V	CH	CF316CH220J500AT	K22271259	25W/CE:ON	9-	B		b1
C 1015	FILM CAP.	33pF	500V		UC232H0330G-T	K33279053	50W	9-	B		b1
C 1016	CHIP CAP.	10pF	50V	CH	GRM1552C1H100JZ01D	K22178212		1-	B		a3
C 1017	CHIP CAP.	0.1uF	10V	B	GRM36B104K10PT	K22108802		1-	A		C5
C 1018	CHIP CAP.	1uF	10V	B	ECJ1VB1A105K	K22104806		1-	A		G2
C 1019	AL.ELECTRO.CAP.	100uF	25V		EEE1EA101UP	K48140018		1-	B		j4
C 1020	CHIP CAP.	0.01uF	16V	B	GRM36B103K16PT	K22128804		1-	A		G2
C 1021	CHIP CAP.	0.1uF	25V	B	GRM40B104M25PT	K22140811		1-	B		j3
C 1022	CHIP CAP.	22pF	500V	CH	1206N220J501LT	K22278213		1-8	B		b1
C 1022	CHIP CAP.	18pF	500V	CH	1206N180J501LT	K22278212	25W	9-	B		b1
C 1022	CHIP CAP.	22pF	500V	CH	1206N220J501LT	K22278213	50W	9-	B		b1
C 1023	CHIP CAP.	0.001uF	50V	B	GRM155B11H102KA01D	K22178809		1-	B		j3
C 1024	CHIP CAP.	22pF	50V	CH	GRM1552C1H220JZ01D	K22178220		1-	A		C5
C 1026	CHIP CAP.	22pF	50V	CH	GRM1552C1H220JZ01D	K22178220		1-	A		C4
C 1028	CHIP CAP.	0.01uF	16V	B	GRM36B103K16PT	K22128804		1-	B		a3
C 1029	CHIP CAP.	18pF	500V	CH	1206N180J501LT	K22278212		1-	B		b1
C 1030	CHIP CAP.	0.001uF	50V	B	GRM155B11H102KA01D	K22178809		1-	A		I2
C 1031	CHIP CAP.	0.001uF	50V	B	GRM155B11H102KA01D	K22178809		1-	A		G2
C 1032	CHIP CAP.	0.1uF	10V	B	GRM36B104K10PT	K22108802		1-	B		i3
C 1033	CHIP CAP.	12pF	50V	CH	GRM1552C1H120JZ01D	K22178214		1-	B		a3
C 1034	CHIP CAP.	0.001uF	50V	B	GRM155B11H102KA01D	K22178809		1-	A		H2
C 1035	CHIP CAP.	10uF	6.3V	B	JMK212BJ106KG-T	K22080802		1-	A		D5
C 1036	CHIP CAP.	2.2pF	500V	CH	1206N2R2C501LT	K22278201		1-8	B		d2
C 1036	CHIP CAP.	22pF	500V	CH	1206N220J501LT	K22278213	25W	9-	B		d2
C 1036	CHIP CAP.	2.2pF	500V	CH	1206N2R2C501LT	K22278201	50W	9-	B		d2
C 1037	CHIP CAP.	22pF	50V	CH	GRM1552C1H220JZ01D	K22178220		1-	A		E5
C 1038	CHIP CAP.	0.001uF	50V	B	GRM155B11H102KA01D	K22178809		1-	A		H3
C 1040	CHIP CAP.	0.001uF	50V	B	GRM155B11H102KA01D	K22178809		1-	A		I2
C 1041	CHIP CAP.	7pF	50V	CH	GRM1552C1H7R0BZ01D	K22178294		1-	B		b3
C 1042	CERAMIC CAP.	0.001uF	100V	CH	GRM42-6CH102J100PT	K22201202		1-	A		G2
C 1043	FILM CAP.	22pF	500V		UC232H0220J-T	K33279021		1-8	A		G2
C 1043	FILM CAP.	22pF	500V		UC232H0220J-T	K33279021	50W	9-	A		G2
C 1044	CHIP CAP.	5pF	50V	CH	GRM1552C1H5R0CZ01D	K22178207		1-	B		b3
C 1045	CHIP CAP.	0.001uF	50V	B	GRM155B11H102KA01D	K22178809		1-	A		H3
C 1046	CHIP CAP.	0.001uF	50V	B	GRM155B11H102KA01D	K22178809		1-	B		b3
C 1047	CHIP CAP.	0.001uF	50V	B	GRM155B11H102KA01D	K22178809		1-	A		I2
C 1048	CHIP CAP.	0.001uF	50V	B	GRM155B11H102KA01D	K22178809		1-	A		I2
C 1049	CHIP CAP.	0.1uF	25V	B	GRM40B104M25PT	K22140811		1-	A		C2
C 1050	CHIP CAP.	0.1uF	25V	B	GRM40B104M25PT	K22140811		1-	A		B2
C 1051	CHIP CAP.	0.1uF	25V	B	GRM40B104M25PT	K22140811		1-	B		i2
C 1052	AL.ELECTRO.CAP.	10uF	25V		EMVA250ADA100MD55G	K48140014		1-	A		B3
C 1053	CHIP CAP.	0.001uF	50V	B	GRM155B11H102KA01D	K22178809		1-	B		b3
C 1054	CHIP CAP.	0.1uF	25V	B	GRM40B104M25PT	K22140811		1-	A		D2

MAIN Unit

Parts List

REF	DESCRIPTION	VALUE	V/W	TOL.	MFR'S DESIG	VXSTD P/N	VERS.	LOT	SIDE	LAY ADR
C 1055	CHIP CAP.	0.001uF	50V	B	GRM155B11H102KA01D	K22178809		1-	A	F2
C 1056	CHIP CAP.	0.001uF	50V	B	GRM155B11H102KA01D	K22178809		1-	B	i1
C 1057	CHIP CAP.	0.1uF	25V	B	GRM40B104M25PT	K22140811		1-	A	F2
C 1060	CHIP CAP.	0.001uF	50V	B	GRM155B11H102KA01D	K22178809		1-	B	i2
C 1061	CHIP CAP.	0.01uF	16V	B	GRM36B103K16PT	K22128804		1-	A	E5
C 1062	AL.ELECTRO.CAP.	10uF	25V		EMVA250ADA100MD55G	K48140014		1-	A	F2
C 1063	CHIP CAP.	0.001uF	50V	B	GRM155B11H102KA01D	K22178809		1-	A	F2
C 1064	AL.ELECTRO.CAP.	2200uF	25V		RE3-25V222MI6#	K40149055		1-	B	i2
C 1065	CHIP CAP.	150pF	50V	CH	GRM1552C1H151JA01D	K22178240		1-	A	G5
C 1066	CHIP CAP.	0.015uF	16V	B	GRM36B153K16PT	K22128807		1-	A	E5
C 1066	CHIP CAP.	0.022uF	16V	B	GRM36B223K16PT	K22128806		5-10	A	E5
C 1066	CHIP CAP.	0.033uF	10V	B	GRM36B333K10PT	K22108803	CHINA	11-	A	E5
C 1066	CHIP CAP.	0.022uF	16V	B	GRM36B223K16PT	K22128806	EUROPE	11-	A	E5
C 1066	CHIP CAP.	0.022uF	16V	B	GRM36B223K16PT	K22128806	EXPORT	11-	A	E5
C 1066	CHIP CAP.	0.022uF	16V	B	GRM36B223K16PT	K22128806	VTX(USA)	11-	A	E5
C 1067	CHIP CAP.	0.001uF	50V	B	GRM155B11H102KA01D	K22178809		1-	A	F2
C 1069	CHIP CAP.	100pF	50V	CH	GRM1552C1H101JD01D	K22178236		1-	A	C5
C 1070	CHIP CAP.	0.001uF	50V	B	GRM155B11H102KA01D	K22178809		1-	B	b3
C 1071	CHIP CAP.	0.1uF	10V	B	GRM36B104K10PT	K22108802		1-	A	J2
C 1072	CHIP CAP.	0.001uF	50V	B	GRM155B11H102KA01D	K22178809		1-	A	J2
C 1073	CHIP TA.CAP.	10uF	10V		TEMSVA1A106M-8R	K78100028		1-	A	C3
C 1074	CHIP CAP.	0.01uF	16V	B	GRM36B103K16PT	K22128804		1-	A	A5
C 1075	CHIP CAP.	0.1uF	10V	B	GRM36B104K10PT	K22108802		1-	A	G5
C 1076	CHIP CAP.	100pF	50V	CH	GRM1552C1H101JD01D	K22178236		1-	A	C5
C 1077	CHIP CAP.	100pF	50V	CH	GRM1552C1H101JD01D	K22178236		1-	A	A5
C 1078	CHIP CAP.	0.1uF	10V	B	GRM36B104K10PT	K22108802		1-	A	C3
C 1079	CHIP CAP.	0.033uF	10V	B	GRM36B333K10PT	K22108803		1-	A	E5
C 1080	CHIP CAP.	100pF	50V	CH	GRM1552C1H101JD01D	K22178236		1-	A	C5
C 1081	CHIP CAP.	100pF	50V	CH	GRM1552C1H101JD01D	K22178236		1-	A	A5
C 1083	CHIP CAP.	220pF	25V	CH	GRM36CH221J25PT	K22148203		1-	B	b3
C 1084	CHIP CAP.	100pF	50V	CH	GRM1552C1H101JD01D	K22178236		1-	A	A5
C 1086	CHIP CAP.	100pF	50V	CH	GRM1552C1H101JD01D	K22178236		1-	A	C5
C 1087	CHIP CAP.	0.0015uF	50V	B	GRM155B11H152KA01D	K22178811		1-	A	E5
C 1087	CHIP CAP.	0.0056uF	25V	B	GRM36B562K25PT	K22148802		3-	A	E5
C 1087	CHIP CAP.	0.0068uF	25V	B	GRM36B682K25PT	K22148803		5-10	A	E5
C 1087	CHIP CAP.	0.0082uF	16V	B	GRM36B822K16PT	K22128801	CHINA	11-	A	E5
C 1087	CHIP CAP.	0.0068uF	25V	B	GRM36B682K25PT	K22148803	EUROPE	11-	A	E5
C 1087	CHIP CAP.	0.0068uF	25V	B	GRM36B682K25PT	K22148803	EXPORT	11-	A	E5
C 1087	CHIP CAP.	0.0068uF	25V	B	GRM36B682K25PT	K22148803	VTX(USA)	11-	A	E5
C 1088	CHIP CAP.	100pF	50V	CH	GRM1552C1H101JD01D	K22178236		1-	A	A5
C 1089	CHIP CAP.	0.001uF	50V	B	GRM155B11H102KA01D	K22178809		1-	B	b3
C 1090	CHIP CAP.	0.001uF	50V	B	GRM155B11H102KA01D	K22178809		1-	B	f2
C 1091	CHIP CAP.	100pF	50V	CH	GRM1552C1H101JD01D	K22178236		1-	A	C5
C 1092	CHIP CAP.	0.001uF	50V	B	GRM155B11H102KA01D	K22178809		1-	B	f2
C 1093	CHIP CAP.	0.001uF	50V	B	GRM155B11H102KA01D	K22178809		1-	B	b3
C 1095	CHIP CAP.	22pF	50V	CH	GRM1552C1H220JZ01D	K22178220		1-	B	b3
C 1096	CHIP CAP.	0.1uF	10V	B	GRM36B104K10PT	K22108802		1-	A	G5
C 1097	CHIP CAP.	0.0047uF	25V	B	GRM36B472K25PT	K22148830		1-	A	G5
C 1098	CHIP CAP.	100pF	50V	CH	GRM1552C1H101JD01D	K22178236		1-	A	C5
C 1099	CHIP CAP.	1uF	10V	B	ECJ1VB1A105K	K22104806		1-	B	f2
C 1100	CHIP CAP.	0.022uF	16V	B	GRM36B223K16PT	K22128806		1-	A	G5
C 1102	CHIP CAP.	100pF	50V	CH	GRM1552C1H101JD01D	K22178236		1-	A	C5
C 1103	CHIP CAP.	33pF	50V	CH	GRM1552C1H330JZ01D	K22178224		1-	B	b3
C 1104	CHIP CAP.	47pF	50V	CH	GRM1552C1H470JZ01D	K22178228		1-	B	f2
C 1105	CHIP CAP.	100pF	50V	CH	GRM1552C1H101JD01D	K22178236		1-	A	B5
C 1106	CHIP CAP.	0.1uF	10V	B	GRM36B104K10PT	K22108802		1-	A	E5
C 1107	CHIP CAP.	100pF	50V	CH	GRM1552C1H101JD01D	K22178236		1-	A	B5
C 1108	CHIP CAP.	0.001uF	50V	B	GRM155B11H102KA01D	K22178809		1-	B	f2
C 1109	CHIP CAP.	0.0022uF	50V	B	GRM155B11H222KA01D	K22178813		1-	A	J2
C 1110	CHIP CAP.	0.1uF	10V	B	GRM36B104K10PT	K22108802		1-	A	F4
C 1111	CHIP CAP.	33pF	50V	CH	GRM1552C1H330JZ01D	K22178224		1-	B	b3
C 1112	CHIP CAP.	8pF	50V	CH	GRM1552C1H8R0BZ01D	K22178295		1-	B	b3
C 1113	CHIP CAP.	0.01uF	16V	B	GRM36B103K16PT	K22128804		1-	B	f2
C 1114	CHIP CAP.	10uF	6.3V	B	JMK212BJ106KG-T	K22080802		1-	A	F4
C 1116	CHIP CAP.	7pF	50V	CH	GRM1552C1H7R0BZ01D	K22178294		1-	B	b3
C 1117	CHIP CAP.	0.0022uF	50V	B	GRM155B11H222KA01D	K22178813		1-	A	J2
C 1118	CHIP CAP.	0.01uF	16V	B	GRM36B103K16PT	K22128804		1-	A	J2
C 1120	CHIP CAP.	0.01uF	16V	B	GRM36B103K16PT	K22128804		1-	A	F4
C 1121	CHIP CAP.	0.047uF	10V	B	GRM36B473K10PT	K22108801		1-	A	J2
C 1122	CHIP CAP.	1pF	50V	CK	GRM1554C1H1R0CZ01D	K22178202		1-	B	c3
C 1123	CHIP CAP.	1.5pF	50V	CK	GRM1554C1H1R5CZ01D	K22178203		1-	B	c3
C 1124	CHIP CAP.	0.001uF	50V	B	GRM155B11H102KA01D	K22178809		1-	A	F4
C 1125	CHIP CAP.	0.01uF	16V	B	GRM36B103K16PT	K22128804		1-	A	G5

MAIN Unit

Parts List

REF	DESCRIPTION	VALUE	V/W	TOL.	MFR'S DESIG	VXSTD P/N	VERS.	LOT	SIDE	LAY ADR
C 1127	CHIP CAP.	8pF	50V	CH	GRM1552C1H8R0BZ01D	K22178295		1-	B	c3
C 1128	CHIP CAP.	7pF	50V	CH	GRM1552C1H7R0BZ01D	K22178294		1-	B	c3
C 1129	CHIP CAP.	33pF	50V	CH	GRM1552C1H330JZ01D	K22178224		1-	B	e2
C 1130	CHIP CAP.	33pF	50V	CH	GRM1552C1H330JZ01D	K22178224		1-	B	c3
C 1131	CHIP CAP.	0.1uF	10V	B	GRM36B104K10PT	K22108802		1-	A	F3
C 1132	CHIP CAP.	0.01uF	16V	B	GRM36B103K16PT	K22128804		1-	A	I4
C 1133	CHIP CAP.	0.001uF	50V	B	GRM155B11H102KA01D	K22178809		1-	B	f2
C 1134	CHIP CAP.	33pF	50V	CH	GRM1552C1H330JZ01D	K22178224		1-	B	c3
C 1136	CHIP CAP.	2.2uF	10V	B	GRM21BB11A225KA01L	K22100804		1-	A	F5
C 1138	CHIP CAP.	0.01uF	16V	B	GRM36B103K16PT	K22128804		1-	B	e2
C 1139	CHIP CAP.	0.001uF	50V	B	GRM155B11H102KA01D	K22178809		1-	B	e2
C 1140	CHIP CAP.	0.1uF	10V	B	GRM36B104K10PT	K22108802		1-	B	j5
C 1141	CHIP CAP.	22pF	50V	CH	GRM1552C1H220JZ01D	K22178220		1-	B	c3
C 1143	CHIP CAP.	0.1uF	10V	B	GRM36B104K10PT	K22108802		1-	A	G4
C 1144	CHIP CAP.	0.01uF	16V	B	GRM36B103K16PT	K22128804		1-	A	I5
C 1145	CHIP CAP.	0.022uF	16V	B	GRM36B223K16PT	K22128806		1-	A	F5
C 1146	CHIP CAP.	0.001uF	50V	B	GRM155B11H102KA01D	K22178809		1-	B	c3
C 1147	CHIP CAP.	7pF	50V	CH	GRM1552C1H7R0DZ01D	K22178209		1-	B	d3
C 1147	CHIP CAP.	4pF	50V	CH	GRM1552C1H4R0CZ01D	K22178206		11-	B	d3
C 1148	CHIP CAP.	3pF	50V	CJ	GRP1553C1H3R0CZ01E	K22178205		1-	B	e2
C 1149	CHIP CAP.	470pF	50V	B	GRM155B11H471KA01D	K22178805		1-	B	d3
C 1150	CHIP CAP.	10pF	50V	CH	GRM1552C1H100JZ01D	K22178212		1-	B	e3
C 1151	CHIP CAP.	0.022uF	50V	B	GRM40B223M50PT	K22170821		1-	A	F4
C 1152	CHIP CAP.	10pF	50V	CH	GRM1552C1H100JZ01D	K22178212		1-	B	e3
C 1153	CHIP CAP.	0.001uF	50V	B	GRM155B11H102KA01D	K22178809		1-	A	H4
C 1154	CHIP CAP.	0.001uF	50V	B	GRM155B11H102KA01D	K22178809		1-	B	e3
C 1155	CHIP CAP.	0.001uF	50V	B	GRM155B11H102KA01D	K22178809		1-	B	d3
C 1156	CHIP CAP.	0.001uF	50V	B	GRM155B11H102KA01D	K22178809		1-	B	d3
C 1157	CHIP CAP.	0.01uF	16V	B	GRM36B103K16PT	K22128804		1-	B	e2
C 1158	CHIP CAP.	100pF	50V	CH	GRM1552C1H101JD01D	K22178236		1-	A	H5
C 1159	CHIP CAP.	0.001uF	50V	B	GRM155B11H102KA01D	K22178809		1-	B	e3
C 1160	CHIP CAP.	0.001uF	50V	B	GRM155B11H102KA01D	K22178809		1-	A	H3
C 1163	CHIP CAP.	0.001uF	50V	B	GRM155B11H102KA01D	K22178809		1-	B	e3
C 1164	CHIP CAP.	0.001uF	50V	B	GRM155B11H102KA01D	K22178809		1-	A	H5
C 1165	CHIP CAP.	7pF	50V	CH	GRM1552C1H7R0DZ01D	K22178209		1-	A	H4
C 1166	CHIP CAP.	0.01uF	16V	B	GRM36B103K16PT	K22128804		1-	B	e3
C 1167	CHIP CAP.	0.001uF	50V	B	GRM155B11H102KA01D	K22178809		1-	B	f3
C 1169	CHIP CAP.	1pF	50V	CK	GRM1554C1H1R0BZ01D	K22178287		1-	B	e3
C 1171	CHIP CAP.	0.001uF	50V	B	GRM155B11H102KA01D	K22178809		1-	A	H4
C 1172	CHIP CAP.	1pF	50V	CK	GRM1554C1H1R0BZ01D	K22178287		1-	B	f3
C 1173	CHIP CAP.	0.1uF	10V	B	GRM36B104K10PT	K22108802		1-	A	D4
C 1174	CHIP CAP.	0.001uF	50V	B	GRM155B11H102KA01D	K22178809		1-	A	H4
C 1176	CHIP CAP.	0.01uF	16V	B	GRM36B103K16PT	K22128804		1-	B	f3
C 1177	CHIP CAP.	1pF	50V	CK	GRM1554C1H1R0CZ01D	K22178202		1-	A	H4
C 1178	CHIP CAP.	0.001uF	50V	B	GRM155B11H102KA01D	K22178809		1-	B	f5
C 1179	CHIP CAP.	8pF	50V	CH	GRM1552C1H8R0DZ01D	K22178210		1-	A	H4
C 1180	CHIP CAP.	0.001uF	50V	B	GRM155B11H102KA01D	K22178809		1-	B	f3
C 1181	CHIP CAP.	1.5pF	50V	CK	GRM1554C1H1R5BZ01D	K22178288		1-	B	e3
C 1182	CHIP CAP.	0.1uF	10V	B	GRM36B104K10PT	K22108802		1-	B	d5
C 1184	CHIP CAP.	15pF	50V	CH	GRM1552C1H150JZ01D	K22178216		1-	B	f3
C 1186	CHIP TA.CAP.	10uF	10V		TEMSVA1A106M-8R	K78100028		1-	B	f3
C 1187	CHIP CAP.	15pF	50V	CH	GRM1552C1H150JZ01D	K22178216		1-	B	f3
C 1189	CHIP CAP.	0.001uF	50V	B	GRM155B11H102KA01D	K22178809		1-	B	f3
C 1190	CHIP CAP.	0.001uF	50V	B	GRM155B11H102KA01D	K22178809		1-	B	f3
C 1191	CHIP CAP.	27pF	50V	CH	GRM1552C1H270JZ01D	K22178222		1-	B	e3
C 1192	CHIP CAP.	39pF	50V	CH	GRM1552C1H390JZ01D	K22178226		1-10	A	H5
C 1192	CHIP CAP.	27pF	50V	CH	GRM1552C1H270JZ01D	K22178222	CHINA	11-	A	H5
C 1192	CHIP CAP.	39pF	50V	CH	GRM1552C1H390JZ01D	K22178226	EUROPE	11-	A	H5
C 1192	CHIP CAP.	39pF	50V	CH	GRM1552C1H390JZ01D	K22178226	EXPORT	11-	A	H5
C 1192	CHIP CAP.	39pF	50V	CH	GRM1552C1H390JZ01D	K22178226	VTX(USA)	11-	A	H5
C 1193	CHIP CAP.	10pF	50V	CH	GRM1552C1H100JZ01D	K22178212		1-	B	f3
C 1195	CHIP CAP.	18pF	50V	CH	GRM1552C1H180JZ01D	K22178218		1-	B	e3
C 1196	CHIP CAP.	0.0047uF	25V	B	GRM36B472K25PT	K22148830		1-	A	D5
C 1197	CHIP CAP.	0.1uF	10V	B	GRM36B104K10PT	K22108802		1-	A	F3
C 1198	CHIP CAP.	39pF	50V	CH	GRM1552C1H390JZ01D	K22178226		1-	A	I4
C 1199	CHIP CAP.	47pF	50V	CH	GRM1552C1H470JZ01D	K22178228		1-	B	e3
C 1200	CHIP CAP.	0.1uF	10V	B	GRM36B104K10PT	K22108802		1-	A	D5
C 1201	CHIP CAP.	0.1uF	10V	B	GRM36B104K10PT	K22108802		1-	A	G5
C 1202	CHIP TA.CAP.	10uF	10V		TEMSVA1A106M-8R	K78100028		1-	B	f3
C 1203	CHIP CAP.	0.001uF	50V	B	GRM155B11H102KA01D	K22178809		1-	A	H5
C 1204	CHIP CAP.	0.1uF	10V	B	GRM36B104K10PT	K22108802		1-	B	c4
C 1206	CHIP CAP.	0.1uF	10V	B	GRM36B104K10PT	K22108802		1-	A	G5
C 1208	CHIP CAP.	0.001uF	50V	B	GRM155B11H102KA01D	K22178809		1-	B	f3

MAIN Unit

Parts List

REF	DESCRIPTION	VALUE	V/W	TOL.	MFR'S DESIG	VXSTD P/N	VERS.	LOT	SIDE	LAY ADR
C 1209	CHIP CAP.	15pF	50V	CH	GRM1552C1H150JZ01D	K22178216		1-	B	f4
C 1209	CHIP CAP.	12pF	50V	CH	GRM1552C1H120JZ01D	K22178214		3-	B	f4
C 1210	CHIP TA.CAP.	2.2uF	6.3V		TESVA0J225M1-8R	K78080009		1-	A	F4
C 1211	CHIP CAP.	82pF	50V	CH	GRM1552C1H820JD01D	K22178234		1-	B	f4
C 1212	CHIP CAP.	1uF	10V	B	ECJ1VB1A105K	K22104806		1-	A	G5
C 1214	CHIP CAP.	0.001uF	50V	B	GRM155B11H102KA01D	K22178809		1-	A	H5
C 1215	CHIP CAP.	10pF	50V	CH	GRM1552C1H100JZ01D	K22178212		1-	B	e4
C 1216	CHIP CAP.	0.01uF	16V	B	GRM36B103K16PT	K22128804		1-	B	b4
C 1217	CHIP CAP.	0.001uF	50V	B	GRM155B11H102KA01D	K22178809		1-	B	f3
C 1218	CHIP CAP.	4.7uF	6.3V	B	JMK212BJ475KG-T	K22080804		1-	A	E4
C 1220	CHIP CAP.	47pF	50V	CH	GRM1552C1H470JZ01D	K22178228		1-	B	e4
C 1221	CHIP CAP.	0.01uF	16V	B	GRM36B103K16PT	K22128804		1-	A	E4
C 1223	CHIP CAP.	0.01uF	16V	B	GRM36B103K16PT	K22128804		1-	A	G5
C 1224	CHIP CAP.	5pF	50V	CH	GRM1552C1H5R0CZ01D	K22178207		1-	A	H5
C 1225	CHIP CAP.	1uF	10V	B	GRM40B105K10PT(0.85)	K22100803		1-	A	H5
C 1226	CHIP CAP.	33pF	50V	CH	GRM1552C1H330JZ01D	K22178224		1-	B	b4
C 1227	CHIP TA.CAP.	4.7uF	6.3V		TEMSVA0J475M-8R	K78080017		1-	A	E3
C 1227	CHIP TA.CAP.	10uF	10V		TEMSVA1A106M-8R	K78100028		7-	A	E3
C 1229	CHIP CAP.	0.0022uF	50V	B	GRM155B11H222KA01D	K22178813		1-	A	G5
C 1230	CHIP CAP.	0.01uF	16V	B	GRM36B103K16PT	K22128804		1-	B	b4
C 1231	CHIP CAP.	0.047uF	10V	B	GRM36B473K10PT	K22108801		1-4	A	F4
C 1232	CHIP CAP.	0.001uF	50V	B	GRM155B11H102KA01D	K22178809		1-	A	H5
C 1233	CHIP TA.CAP.	4.7uF	16V		TEMSVA1C475M-8R	K78120031		1-	A	E4
C 1234	CHIP CAP.	0.047uF	10V	B	GRM36B473K10PT	K22108801		1-	B	b4
C 1235	CHIP CAP.	0.01uF	16V	B	GRM36B103K16PT	K22128804		1-	A	G5
C 1236	CHIP CAP.	0.001uF	50V	B	GRM155B11H102KA01D	K22178809		1-	A	E4
C 1237	CHIP CAP.	0.022uF	16V	B	GRM36B223K16PT	K22128806		1-	A	I5
C 1239	CHIP CAP.	0.01uF	16V	B	GRM36B103K16PT	K22128804		1-	B	b4
C 1240	CHIP CAP.	39pF	50V	CH	GRM1552C1H390JZ01D	K22178226		1-	B	b4
C 1241	CHIP CAP.	0.0047uF	25V	B	GRM36B472K25PT	K22148830		1-	A	I5
C 1242	CHIP CAP.	0.0047uF	25V	B	GRM36B472K25PT	K22148830		1-	A	H5
C 1242	CHIP CAP.	0.0022uF	50V	B	GRM155B11H222KA01D	K22178813		5-	A	H5
C 1243	CHIP CAP.	0.047uF	10V	B	GRM36B473K10PT	K22108801		1-4	B	e4
C 1244	CHIP CAP.	12pF	50V	CH	GRM1552C1H120JZ01D	K22178214		1-	B	e3
C 1245	CHIP CAP.	12pF	50V	CH	GRM1552C1H120JZ01D	K22178214		1-	B	d3
C 1246	CHIP CAP.	0.01uF	16V	B	GRM36B103K16PT	K22128804		1-	B	b4
C 1247	CHIP CAP.	0.01uF	16V	B	GRM36B103K16PT	K22128804		1-	A	G5
C 1248	CHIP CAP.	22pF	50V	CH	GRM1552C1H220JZ01D	K22178220		1-	B	b4
C 1249	CHIP CAP.	0.0047uF	25V	B	GRM36B472K25PT	K22148830		1-	A	G5
C 1250	CHIP CAP.	0.1uF	10V	B	GRM36B104K10PT	K22108802		1-	B	b4
C 1251	CHIP CAP.	82pF	50V	CH	GRM1552C1H820JD01D	K22178234		1-	B	b4
C 1252	CHIP CAP.	0.1uF	10V	B	GRM36B104K10PT	K22108802		1-	B	b4
C 1253	CHIP CAP.	0.01uF	16V	B	GRM36B103K16PT	K22128804		1-	B	e4
C 1254	CHIP CAP.	27pF	50V	CH	GRM1552C1H270JZ01D	K22178222		1-	B	e3
C 1255	CHIP CAP.	22pF	50V	CH	GRM1552C1H220JZ01D	K22178220		1-	B	d3
C 1256	CHIP TA.CAP.	0.68uF	20V		TESVA1D684M1-8R	K78130009		1-	B	d4
C 1257	CHIP CAP.	22pF	50V	CH	GRM1552C1H220JZ01D	K22178220		1-	B	e3
C 1258	CHIP CAP.	12pF	50V	CH	GRM1552C1H120JZ01D	K22178214		1-	B	d3
C 1259	CHIP CAP.	180pF	25V	CH	GRM36CH181J25PT	K22148201		1-	A	I5
C 1260	CHIP CAP.	0.001uF	50V	B	GRM155B11H102KA01D	K22178809		1-	A	D3
C 1261	CHIP CAP.	0.0033uF	50V	B	GRM155B11H332KA01D	K22178815		1-	A	J5
C 1262	CHIP TA.CAP.	0.15uF	35V		TESVA1V154M1-8R	K78160026		1-	B	d4
C 1263	CHIP CAP.	0.0047uF	25V	B	GRM36B472K25PT	K22148830		1-	B	b4
C 1264	CHIP TA.CAP.	4.7uF	16V		TEMSVA1C475M-8R	K78120031		1-	A	D3
C 1264	CHIP TA.CAP.	4.7uF	20V		TEMSVA1D475M-8R	K78130048		7-	A	D3
C 1265	CHIP TA.CAP.	10uF	10V		TEMSVA1A106M-8R	K78100028		1-	B	b5
C 1266	CHIP CAP.	0.1uF	10V	B	GRM36B104K10PT	K22108802		1-	A	J5
C 1267	AL.ELECTRO.CAP.	100uF	25V		EEE1EA101UP	K48140018		1-	B	h2
C 1268	CHIP CAP.	470pF	50V	B	GRM155B11H471KA01D	K22178805		1-	B	c4
C 1268	CHIP CAP.	0.001uF	50V	B	GRM155B11H102KA01D	K22178809		5-	B	c4
C 1269	CHIP CAP.	0.001uF	50V	B	GRM155B11H102KA01D	K22178809		1-	B	e4
C 1270	CHIP CAP.	0.01uF	16V	B	GRM36B103K16PT	K22128804		1-	B	b4
C 1271	CHIP CAP.	0.001uF	50V	B	GRM155B11H102KA01D	K22178809		1-	B	d4
C 1272	CHIP CAP.	4.7uF	6.3V	B	JMK212BJ475KG-T	K22080804		1-	A	F3
C 1273	CHIP CAP.	0.01uF	16V	B	GRM36B103K16PT	K22128804		1-	B	j4
C 1274	CHIP CAP.	0.001uF	50V	B	GRM155B11H102KA01D	K22178809		1-	B	i4
C 1275	CHIP CAP.	100pF	50V	CH	GRM1552C1H101JD01D	K22178236		1-	A	I5
C 1276	CHIP CAP.	470pF	50V	B	GRM155B11H471KA01D	K22178805		1-	B	b4
C 1276	CHIP CAP.	0.001uF	50V	B	GRM155B11H102KA01D	K22178809		5-	B	b4
C 1277	CHIP CAP.	0.1uF	10V	B	GRM36B104K10PT	K22108802		1-	B	d4
C 1278	CHIP CAP.	0.1uF	10V	B	GRM36B104K10PT	K22108802		1-	A	I4
C 1279	CHIP CAP.	0.001uF	50V	B	GRM155B11H102KA01D	K22178809		1-	B	d4
C 1280	CHIP CAP.	0.1uF	10V	B	GRM36B104K10PT	K22108802		1-	B	j4

MAIN Unit

Parts List

REF	DESCRIPTION	VALUE	V/W	TOL.	MFR'S DESIG	VXSTD P/N	VERS.	LOT	SIDE	LAY ADR
C 1281	CHIP CAP.	0.01uF	16V	B	GRM36B103K16PT	K22128804		1-	B	b4
C 1282	CHIP CAP.	0.1uF	10V	B	GRM36B104K10PT	K22108802		1-	A	F3
C 1283	CHIP CAP.	0.001uF	50V	B	GRM155B11H102KA01D	K22178809		1-	B	e4
C 1284	CHIP CAP.	8pF	50V	CH	GRM1552C1H8R0DZ01D	K22178210		1-	A	B4
C 1286	CHIP CAP.	0.01uF	16V	B	GRM36B103K16PT	K22128804		1-	B	i2
C 1287	CHIP CAP.	0.1uF	10V	B	GRM36B104K10PT	K22108802		1-	B	d3
C 1288	CHIP CAP.	8pF	50V	CH	GRM1552C1H8R0DZ01D	K22178210		1-	A	B4
C 1289	CHIP CAP.	0.01uF	16V	B	GRM36B103K16PT	K22128804		1-	B	j4
C 1290	CHIP CAP.	0.01uF	16V	B	GRM36B103K16PT	K22128804		1-	A	D3
C 1291	CHIP CAP.	0.01uF	16V	B	GRM36B103K16PT	K22128804		1-	A	D3
C 1292	CHIP CAP.	0.1uF	10V	B	GRM36B104K10PT	K22108802		1-	A	I5
C 1293	CHIP CAP.	0.1uF	10V	B	GRM36B104K10PT	K22108802		1-	B	a4
C 1294	CHIP CAP.	0.001uF	50V	B	GRM155B11H102KA01D	K22178809		1-	A	D3
C 1295	CHIP CAP.	0.001uF	50V	B	GRM155B11H102KA01D	K22178809		1-	B	j4
C 1296	CHIP CAP.	1uF	10V	B	ECJ1VB1A105K	K22104806		1-	A	I5
C 1297	CHIP CAP.	0.01uF	16V	B	GRM36B103K16PT	K22128804		1-	B	i2
C 1298	CHIP CAP.	4.7uF	6.3V	B	JMK212BJ475KG-T	K22080804		1-	A	D3
C 1299	CHIP CAP.	0.001uF	50V	B	GRM155B11H102KA01D	K22178809		1-	B	i4
C 1300	CHIP CAP.	0.001uF	50V	B	GRM155B11H102KA01D	K22178809		1-	B	d4
C 1301	CHIP CAP.	0.1uF	10V	B	GRM36B104K10PT	K22108802		1-	B	b5
C 1302	CHIP CAP.	0.1uF	10V	B	GRM36B104K10PT	K22108802		1-	B	d4
C 1303	CHIP CAP.	0.01uF	16V	B	GRM36B103K16PT	K22128804		1-	B	j5
C 1304	CHIP CAP.	0.001uF	50V	B	GRM155B11H102KA01D	K22178809		1-	A	B5
C 1305	CHIP CAP.	470pF	50V	B	GRM155B11H471KA01D	K22178805		1-	B	b5
C 1305	CHIP CAP.	820pF	50V	B	GRM36B821K50PT	K22178808		5-	B	b5
C 1306	CHIP CAP.	0.0047uF	25V	B	GRM36B472K25PT	K22148830		1-	A	I5
C 1307	CHIP TA.CAP.	10uF	10V		TEMSVA1A106M-8R	K78100028		1-	B	d4
C 1308	CHIP CAP.	0.001uF	50V	B	GRM155B11H102KA01D	K22178809		1-	B	d4
C 1309	CHIP CAP.	0.01uF	16V	B	GRM36B103K16PT	K22128804		1-	B	j5
C 1310	CHIP CAP.	0.1uF	10V	B	GRM36B104K10PT	K22108802		1-	B	d4
C 1311	CHIP CAP.	0.1uF	10V	B	GRM36B104K10PT	K22108802		1-	A	B5
C 1312	CHIP CAP.	470pF	50V	B	GRM155B11H471KA01D	K22178805		1-	B	b5
C 1312	CHIP CAP.	820pF	50V	B	GRM36B821K50PT	K22178808		5-	B	b5
C 1313	CHIP CAP.	0.01uF	16V	B	GRM36B103K16PT	K22128804		1-	B	j2
C 1314	CHIP CAP.	0.01uF	16V	B	GRM36B103K16PT	K22128804		1-	A	J4
C 1315	CHIP CAP.	0.047uF	10V	B	GRM36B473K10PT	K22108801		1-	B	d4
C 1316	CHIP CAP.	0.1uF	10V	B	GRM36B104K10PT	K22108802		1-	B	a4
C 1317	CHIP CAP.	0.01uF	16V	B	GRM36B103K16PT	K22128804		1-	B	j2
C 1319	CHIP TA.CAP.	4.7uF	16V		TEMSVA1C475M-8R	K78120031		1-	B	c5
C 1321	CHIP CAP.	0.001uF	50V	B	GRM155B11H102KA01D	K22178809		1-	B	b5
C 1323	CHIP CAP.	100pF	50V	CH	GRM1552C1H101JD01D	K22178236		1-	B	i2
C 1324	CHIP CAP.	0.0015uF	50V	B	GRM155B11H152KA01D	K22178811		1-	B	b5
C 1326	CHIP CAP.	0.01uF	16V	B	GRM36B103K16PT	K22128804		1-	B	b5
C 1327	CHIP CAP.	0.1uF	10V	B	GRM36B104K10PT	K22108802	CHINA	9-	B	f5
C 1327	CHIP CAP.	0.1uF	10V	B	GRM36B104K10PT	K22108802	VTX(USA)	9-	B	f5
C 1328	CHIP CAP.	22pF	50V	CH	GRM1552C1H220JZ01D	K22178220	CHINA	9-	B	f5
C 1328	CHIP CAP.	22pF	50V	CH	GRM1552C1H220JZ01D	K22178220	VTX(USA)	9-	B	f5
C 1329	CHIP CAP.	0.01uF	16V	B	GRM36B103K16PT	K22128804		1-	B	b5
C 1330	CHIP CAP.	100pF	50V	CH	GRM1552C1H101JD01D	K22178236		1-	A	B2
C 1331	CHIP CAP.	100pF	50V	CH	GRM1552C1H101JD01D	K22178236		1-	B	i1
C 1333	CHIP CAP.	22pF	50V	CH	GRM1552C1H220JZ01D	K22178220	CHINA	9-	B	g5
C 1333	CHIP CAP.	22pF	50V	CH	GRM1552C1H220JZ01D	K22178220	VTX(USA)	9-	B	g5
C 1335	CHIP CAP.	100pF	50V	CH	GRM1552C1H101JD01D	K22178236		1-	B	j1
C 1337	CHIP CAP.	0.1uF	10V	B	GRM36B104K10PT	K22108802		1-	A	C3
C 1341	CHIP CAP.	0.022uF	16V	B	GRM36B223K16PT	K22128806		1-	A	G5
C 1342	CHIP CAP.	4.7uF	6.3V	B	JMK212BJ475KG-T	K22080804		1-	A	C5
C 1343	CHIP CAP.	0.01uF	16V	B	GRM36B103K16PT	K22128804	CHINA	9-	B	f4
C 1343	CHIP CAP.	0.01uF	16V	B	GRM36B103K16PT	K22128804	VTX(USA)	9-	B	f4
C 1344	CHIP CAP.	0.022uF	16V	B	GRM36B223K16PT	K22128806	CHINA	9-	B	f5
C 1344	CHIP CAP.	0.022uF	16V	B	GRM36B223K16PT	K22128806	VTX(USA)	9-	B	f5
C 1345	CHIP CAP.	0.01uF	16V	B	GRM36B103K16PT	K22128804		1-	A	B4
C 1350	CHIP CAP.	100pF	50V	CH	GRM1882C1H101JA01D	K22174235		1-	A	A5
C 1350	CHIP CAP.	100pF	50V	CH	GRM1552C1H101JD01D	K22178236		5-	A	A5
C 1351	CHIP CAP.	0.001uF	50V	B	GRM155B11H102KA01D	K22178809		5-	A	G5
C 1352	CHIP CAP.	0.1uF	10V	B	GRM36B104K10PT	K22108802		5-	A	G5
C 1353	CHIP CAP.	4.7uF	6.3V	B	JMK212BJ475KG-T	K22080804		5-	B	d5
C 1354	CHIP CAP.	0.01uF	16V	B	GRM36B103K16PT	K22128804		5-	B	d5
C 1355	CHIP TA.CAP.	0.1uF	35V		TESVA1V104M1-8R	K78160025		5-	A	F4
C 1356	CHIP CAP.	0.1uF	10V	B	GRM36B104K10PT	K22108802		5-	A	H5
C 1357	CHIP TA.CAP.	3.3uF	6.3V		TESVA0J335M1-8R	K78080021	W/ CE	9-	A	J2
C 1358	CHIP CAP.	3.3pF	500V		1206N3R3C501LT	K22278203	W/ CE	9-		
C 1359	CHIP CAP.	47pF	50V	CH	GRM1882C1H470JA01D	K22174227	W/ CE	9-		
CD1001	CERAMIC DISC				JTBC450C7	H7901500		1-	B	b5

MAIN Unit

Parts List

REF	DESCRIPTION	VALUE	V/W	TOL.	MFR'S DESIG	VXSTD P/N	VERS.	LOT	SIDE	LAY ADR
CF1001	CERAMIC FILTER				LTM450EW	H3900574		1-	A	J4
CF1002	CERAMIC FILTER				LTM450GW	H3900573		1-	A	J4
D 1001	DIODE				RLS135 TE-11	G2070128		1-	B	b2
D 1002	SURGE ABSORBER				P6KE27-MT25	Q9000854		1-	A	C1
D 1003	DIODE				1SV323(TPH3.F)	G2071006		1-	B	a3
D 1004	DIODE				1SV323(TPH3.F)	G2071006		1-	B	a3
D 1005	DIODE				1SV323(TPH3.F)	G2071006		1-	B	a3
D 1006	DIODE				1SV323(TPH3.F)	G2071006		1-	B	a3
D 1007	DIODE				HSM88AS TR	G2070170		1-	A	H2
D 1008	DIODE				HSM88AS TR	G2070170		1-	A	I2
D 1009	DIODE				MA2S111-(TX)	G2070614		1-	B	b3
D 1011	DIODE				MA2S111-(TX)	G2070614		1-	A	J2
D 1012	DIODE				MA2S111-(TX)	G2070614		1-	A	F3
D 1013	DIODE				MAZ816000L	G2071120		1-	A	B5
D 1014	DIODE				UDZS TE-17 6.8B	G2070888		1-	A	B5
D 1015	DIODE				MAZ816000L	G2071120		1-	A	A5
D 1016	DIODE				MA2S111-(TX)	G2070614		1-	A	J2
D 1017	DIODE				UDZS TE-17 6.8B	G2070888		1-	A	B5
D 1018	DIODE				MA2S111-(TX)	G2070614		1-	A	J2
D 1019	DIODE				MA2S111-(TX)	G2070614		1-	B	i5
D 1020	DIODE				DAN222 TL	G2070174		1-	B	e2
D 1021	DIODE				MC2850-T11-1	G2070704		1-	B	i4
D 1022	DIODE				MA2S111-(TX)	G2070614		1-	B	i5
D 1023	DIODE				HVC383B TRF-E	G2070922		1-	B	e3
D 1024	DIODE				MA2S111-(TX)	G2070614		1-	B	f3
D 1025	DIODE				1SV325(TPH3.F)	G2070848		1-	B	f4
D 1026	DIODE				HVC376B TRF-E	G2071122		1-	B	e4
D 1027	DIODE				MC2850-T11-1	G2070704		1-	B	c4
D 1028	DIODE				1SV325(TPH3.F)	G2070848		1-	B	f4
D 1029	DIODE				1SV325(TPH3.F)	G2070848		1-	B	f4
D 1030	DIODE				1SV325(TPH3.F)	G2070848		1-	B	e4
D 1031	DIODE				1SV325(TPH3.F)	G2070848		1-	B	f4
D 1032	DIODE				1SV325(TPH3.F)	G2070848		1-	B	f4
D 1033	DIODE				HSC277TRF-E	G2070584		1-	B	e3
D 1034	DIODE				HSC277TRF-E	G2070584		1-	B	e3
D 1035	DIODE				DAN222 TL	G2070174		1-	B	a4
D 1036	DIODE				MA2S111-(TX)	G2070614		1-	A	D3
D 1037	DIODE				HSC277TRF-E	G2070584		1-	B	e3
D 1038	DIODE				HSC277TRF-E	G2070584		1-	B	e3
D 1039	DIODE				DAN222 TL	G2070174		1-	B	a4
D 1041	DIODE				MC2850-T11-1	G2070704		1-	B	j4
D 1042	DIODE				MC2850-T11-1	G2070704		1-	A	J5
D 1043	DIODE				MA2S111-(TX)	G2070614		1-	B	i4
D 1044	DIODE				MA2S111-(TX)	G2070614		1-	B	j5
D 1045	DIODE				MA2S111-(TX)	G2070614		1-	B	d4
D 1046	DIODE				MC2850-T11-1	G2070704		1-	B	i1
D 1047	DIODE				MC2850-T11-1	G2070704		1-	B	b5
D 1048	DIODE				MC2850-T11-1	G2070704		1-	B	b5
D 1049	DIODE				MAZ816000L	G2071120		1-	B	j1
D 1050	DIODE				MAZ816000L	G2071120		1-	A	A1
D 1051	DIODE				MAZ816000L	G2071120		1-	A	B1
D 1052	DIODE				MAZ816000L	G2071120		1-	A	B1
D 1053	DIODE				MC2850-T11-1	G2070704		1-	B	i1
D 1054	DIODE				MC2850-T11-1	G2070704		1-	B	j1
D 1055	DIODE				MAZ816000L	G2071120		1-	A	B1
D 1056	DIODE				MAZ816000L	G2071120		1-	B	j1
D 1057	DIODE				MAZ816000L	G2071120		1-	A	A1
D 1058	DIODE				MAZ816000L	G2071120		1-	A	B2
D 1059	DIODE				MAZ816000L	G2071120		1-	A	B1
D 1060	DIODE				MC2850-T11-1	G2070704		1-	A	E4
D 1061	DIODE				MC2850-T11-1	G2070704		1-	A	F3
D 1062	DIODE				MA2S111-(TX)	G2070614	CHINA	9-	B	f4
D 1062	DIODE				MA2S111-(TX)	G2070614	VTX(USA)	9-	B	f4
D 1063	DIODE				UDZS TE-17 6.8B	G2070888		9-	B	h3
D 1064	DIODE				UDZS TE-17 6.8B	G2070888		9-	B	j2
F 1001	CHIP FUSE	0.25A			0434.250 0.25A	Q0000106		1-	A	B2
J 1003	CONNECTOR				18FLT-SM1-TB	P1091176		1-	A	C5
J 1004	CONNECTOR				657PCB-HIL	P1091290		1-	B	j6
J 1005	CONNECTOR				AXK6S40535P	P0091209		1-	A	D4
J 1006	CONNECTOR				AE0195-00	P1091177		1-	B	j1
JP1001	CHIP RES.	0	1/16W	5%	RMC1/16 000JATP	J24185000		1-	A	B1
JP1002	CHIP RES.	0	1/16W	5%	RMC1/16 000JATP	J24185000		1-	A	A1
JP1003	CHIP RES.	0	1/16W	5%	RMC1/16 000JATP	J24185000		1-	A	B1

MAIN Unit

Parts List

REF	DESCRIPTION	VALUE	V/W	TOL.	MFR'S DESIG	VXSTD P/N	VERS.	LOT	SIDE	LAY ADR
JP1004	CHIP RES.	0	1/16W	5%	RMC1/16 000JATP	J24185000		1-	A	B1
JP1005	CHIP RES.	0	1/16W	5%	RMC1/16 000JATP	J24185000		1-	A	A1
JP1006	CHIP RES.	0	1/16W	5%	RMC1/16 000JATP	J24185000		1-	A	B1
L 1001	COIL	0.056uH			AS050635-56N	L0022813		1-	B	b2
L 1002	COIL	0.047uH			AS030821-47NJ	L0022824		1-	B	b2
L 1003	COIL	0.033uH			AS1005-33NK	L0022546		1-	B	a2
L 1004	COIL	0.033uH			AS1005-33NK	L0022546		1-	B	b2
L 1005	COIL	0.033uH			AS1005-33NK	L0022546		1-	B	b2
L 1006	CHIP COIL	0.068uH			LQW2BHN68NJ03L	L1690605		1-	B	a3
L 1007	COIL	0.033uH			AS1005-33NK	L0022546		1-	B	b2
L 1008	COIL	0.212uH			AS051047-212N	L0022834		1-	A	G2
L 1009	CHIP COIL	0.068uH			LQW2BHN68NJ03L	L1690605		1-	B	a3
L 1010	M.RFC	0.22uH			HK1608 R22J-T	L1690940		1-	B	b3
L 1011	CHIP COIL	0.082uH			LQW2BHN82NJ03L	L1690619		1-	B	b3
L 1012	M.RFC	0.22uH			HK1608 R22J-T	L1690940		1-	B	f2
L 1013	CHIP COIL	0.082uH			LQW2BHN82NJ03L	L1690619		1-	B	c3
L 1014	CHIP COIL	0.082uH			LQW2BHN82NJ03L	L1690619		1-	B	c3
L 1015	CHIP COIL	0.082uH			LQW2BHN82NJ03L	L1690619		1-	B	c3
L 1016	M.RFC	0.22uH			HK1608 R22J-T	L1690940		1-	B	e2
L 1017	M.RFC	0.082uH			HK1608 82NJ-T	L1690527		1-	B	e2
L 1018	M.RFC	0.082uH			HK1608 82NJ-T	L1690527		1-	B	c3
L 1019	M.RFC	0.082uH			HK1608 82NJ-T	L1690527		1-	B	d3
L 1020	M.RFC	0.047uH			HK1608 47NJ-T	L1690524		1-	B	e3
L 1021	M.RFC	1uH			LK1608 1R0K-T	L1690687		1-	B	e2
L 1022	M.RFC	0.82uH			LK1608 R82K-T	L1690417		1-	A	H4
L 1023	M.RFC	0.22uH			HK1608 R22J-T	L1690940		1-	B	e3
L 1024	M.RFC	1uH			LK1608 1R0K-T	L1690687		1-	B	e3
L 1025	M.RFC	0.39uH		2%	C1608CB-R39G	L1691107		1-	B	f3
L 1026	M.RFC	0.39uH		2%	C1608CB-R39G	L1691107		1-	B	f3
L 1027	CHIP COIL	0.047uH		2%	C2520C-47NG	L1691290		1-	B	f4
L 1028	CHIP COIL	0.033uH		2%	C2520C-33NG	L1691288		1-	B	e4
L 1029	M.RFC	0.39uH			LK1608 R39K-T	L1690413		1-	B	e4
L 1030	M.RFC	1uH			LK1608 1R0K-T	L1690687		1-	B	c4
L 1031	M.RFC	0.22uH			HK1608 R22J-T	L1690940		1-	B	f3
L 1032	M.RFC	0.22uH			HK1608 R22J-T	L1690940		1-	B	f4
L 1033	M.RFC	0.22uH			HK1608 R22J-T	L1690940		1-	B	f4
L 1034	M.RFC	0.22uH			HK1608 R22J-T	L1690940		1-	B	f4
L 1035	M.RFC	0.15uH			HK1608 R15J-T	L1690938		1-	B	b4
L 1036	M.RFC	0.056uH			HK1608 56NJ-T	L1690525		1-	B	e3
L 1037	M.RFC	0.047uH			HK1608 47NJ-T	L1690524		1-	B	e3
L 1038	M.RFC	0.056uH			HK1608 56NJ-T	L1690525		1-	B	e3
L 1039	M.RFC	0.047uH			HK1608 47NJ-T	L1690524		1-	B	e3
L 1040	CHIP COIL	10uH			LQH32MN100K23L	L1690087		1-	A	B3
L 1041	CHIP COIL	100uH			LQH32MN101K23L	L1690099	CHINA	9-	B	f5
L 1041	CHIP COIL	100uH			LQH32MN101K23L	L1690099	VTX(USA)	9-	B	f5
Q 1001	TRANSISTOR				RT1N441U-T11-1	G3070247		1-	B	i3
Q 1002	TRANSISTOR				RT1N441U-T11-1	G3070247		1-	B	i3
Q 1003	IC				TDA1519CTH	G1093778		1-	B	j3
Q 1004	IC				SN74LV4053APWR	G1093870		1-	A	D5
Q 1005	IC				SN74LV4053APWR	G1093870		1-	A	F4
Q 1006	IC				UA78M08CKTPR	G1094157		1-	A	C3
Q 1006	IC				NJM7808DL1A-TE1	G1093802		5-	A	C3
Q 1007	TRANSISTOR				2SC3356-T2B R24	G3333567D		1-	B	b3
Q 1008	FET				MTM231230L	G3070357		1-	A	C2
Q 1009	IC				S-AV32(VX)	G1093916		1-8	A	D1
Q 1009	IC				S-AV33A(VX.Q)	G1094415	25W	9-	A	D1
Q 1009	IC				S-AV32(VX)	G1093916	50W	9-	A	D1
Q 1010	TRANSISTOR				RT1N140U(TAPE)	G3070359		1-	B	h2
Q 1011	FET				MTM231230L	G3070357		1-	A	F3
Q 1012	FET				MTM231230L	G3070357		1-	A	F3
Q 1013	TRANSISTOR				UMG2N TR	G3070088		1-	A	F3
Q 1014	IC				M62364FP 600D	G1093033		1-	A	F5
Q 1015	TRANSISTOR				2SC3357-T2 RF	G3333577F		1-	B	f2
Q 1016	TRANSISTOR				RT1N441U-T11-1	G3070247		1-	A	G3
Q 1017	TRANSISTOR				RT1N441U-T11-1	G3070247		1-	A	J2
Q 1018	TRANSISTOR				2SC4617 TL R	G3346178R		1-	B	j5
Q 1019	TRANSISTOR				2SC4617 TL R	G3346178R		1-	B	i5
Q 1020	TRANSISTOR				2SC4617 TL R	G3346178R		1-	B	i5
Q 1021	TRANSISTOR				RT1N441U-T11-1	G3070247		1-	B	i5
Q 1022	TRANSISTOR				DTA124EE TL	G3070116		1-	B	i5
Q 1023	TRANSISTOR				2SC5226-4-TL	G3352268D		1-	B	e2
Q 1024	TRANSISTOR				2SC5226-4-TL	G3352268D		1-	B	e2
Q 1025	FET				3SK293(TE85L,F)	G4802938		1-	A	H3

MAIN Unit

Parts List

REF	DESCRIPTION	VALUE	V/W	TOL.	MFR'S DESIG	VXSTD P/N	VERS.	LOT	SIDE	LAY ADR
Q 1026	TRANSISTOR				RT1N441U-T11-1	G3070247		1-	A	F5
Q 1027	TRANSISTOR				2SC5226-4-TL	G3352268D		1-	B	e3
Q 1028	TRANSISTOR				RT1N441U-T11-1	G3070247		1-	B	f3
Q 1028	TRANSISTOR				DTC143EE TL	G3070114		7-	B	f3
Q 1029	FET				2SK508-T2B K52 A	G3805087B		1-	B	f3
Q 1030	TRANSISTOR				RT1N140U(TAPE)	G3070359		1-	B	f3
Q 1030	TRANSISTOR				DTC143EE TL	G3070114		7-	B	f3
Q 1031	TRANSISTOR				2SC3356-T2B R24	G3333567D		1-	B	e3
Q 1032	TRANSISTOR				2SC4617 TL R	G3346178R		1-	B	f3
Q 1033	TRANSISTOR				2SC5226-4-TL	G3352268D		1-	B	c4
Q 1034	IC				BH2220FVM-TR	G1094269		1-	A	G3
Q 1035	IC				TAR5S35(TE85L.F)	G1093939		1-	A	E4
Q 1036	IC				NJM2591V-TE1	G1094024		1-	B	b4
Q 1037	FET				2SK880GR(TE85R_F)	G3808807G		1-	B	d4
Q 1038	TRANSISTOR				XN1501-(TX)	G3070149		1-	A	F3
Q 1039	TRANSISTOR				2SB1201S-TL	G3070195		1-	A	E3
Q 1040	IC				LM2902PWR	G1094009		1-	A	H5
Q 1040	IC				NJM12902V-TE1	G1093592		5-	A	H5
Q 1041	TRANSISTOR				RT1N441U-T11-1	G3070247		1-	A	J5
Q 1042	IC				LM2902PWR	G1094009		1-	A	G5
Q 1042	IC				NJM12902V-TE1	G1093592		5-	A	G5
Q 1043	IC				LM2902PWR	G1094009		1-	A	E5
Q 1043	IC				NJM12902V-TE1	G1093592		5-	A	E5
Q 1044	IC				SN74LV4066APWR	G1093871		1-	B	e5
Q 1045	IC				LM2902PWR	G1094009		1-	A	I5
Q 1045	IC				NJM12902V-TE1	G1093592		5-	A	I5
Q 1045	IC				LM2902PWR	G1094009		7-	A	I5
Q 1045	IC				NJM12902V-TE1	G1093592		9-	A	I5
Q 1046	IC				LM2902PWR	G1094009		1-	A	D5
Q 1046	IC				NJM12902V-TE1	G1093592		5-	A	D5
Q 1047	IC				LM2902PWR	G1094009		1-	B	c5
Q 1047	IC				NJM12902V-TE1	G1093592		5-	B	c5
Q 1048	IC				LM2902PWR	G1094009		1-	A	J2
Q 1048	IC				NJM12902V-TE1	G1093592		5-	A	J2
Q 1049	IC				LM2902PWR	G1094009		1-	A	I5
Q 1049	IC				NJM12902V-TE1	G1093592		5-	A	I5
Q 1050	FET				2SK397300L	G3839738		1-	A	B2
Q 1051	IC				S-80835CNMC-B8U-T2-G	G1093606		1-	B	j4
Q 1052	IC				TAR5S50(TE85L.F)	G1093914		1-	A	D3
Q 1053	TRANSISTOR				RT1N441U-T11-1	G3070247		1-	A	B2
Q 1054	IC				ADF4111BRUZ-RL7	G1094342		1-	B	d4
Q 1055	FET				2SK397300L	G3839738		1-	A	B1
Q 1056	TRANSISTOR				2SC4617 TL R	G3346178R		1-	B	j4
Q 1057	TRANSISTOR				RT1N441U-T11-1	G3070247		1-	A	B2
Q 1058	TRANSISTOR				RT1N140U(TAPE)	G3070359		1-	A	B3
Q 1059	TRANSISTOR				RT1N441U-T11-1	G3070247		1-	B	a4
Q 1060	FET				2SK397300L	G3839738		1-	A	A1
Q 1061	IC				BR93L66RFVM-WTR	G1093874		1-	A	B4
Q 1062	TRANSISTOR				RT1N441U-T11-1	G3070247		1-	A	A2
Q 1063	FET				2SK397300L	G3839738		1-	A	A2
Q 1064	TRANSISTOR				RT1N441U-T11-1	G3070247		1-	A	B2
Q 1065	IC				LC87F5CC8A-F57T0-E	✖		1-	A	B4
Q 1066	TRANSISTOR				RT1N441U-T11-1	G3070247		1-	B	i1
Q 1067	TRANSISTOR				RT1N441U-T11-1	G3070247		1-	A	I4
Q 1068	IC				LC73881M-TLM	G1092755	CHINA	9-	B	g5
Q 1068	IC				LC73881M-TLM	G1092755	VTX(USA)	9-	B	g5
Q 1069	TRANSISTOR				RT1N441U-T11-1	G3070247	CHINA	9-	B	g5
Q 1069	TRANSISTOR				RT1N441U-T11-1	G3070247	VTX(USA)	9-	B	g5
Q 1070	FET				2SK397300L	G3839738		1-	A	B2
Q 1072	TRANSISTOR				DTA124EE TL	G3070116		9-	A	J5
Q 1073	TRANSISTOR				RT1N441U-T11-1	G3070247		9-	B	g5
R 1001	CHIP RES.	12k	1/16W	5%	RMC1/16S 123JTH	J24189038		1-	B	i3
R 1002	CHIP RES.	47k	1/16W	5%	RMC1/16S 473JTH	J24189045		1-	A	C4
R 1002	CHIP RES.	22k	1/16W	5%	RMC1/16S 223JTH	J24189041		3-	A	C4
R 1003	CHIP RES.	10k	1/16W	5%	RMC1/16S 103JTH	J24189037		1-	B	i3
R 1004	CHIP RES.	4.7k	1/16W	5%	RMC1/16S 472JTH	J24189033		1-	A	G2
R 1005	CHIP RES.	47k	1/16W	5%	RMC1/16S 473JTH	J24189045		1-	A	C5
R 1005	CHIP RES.	22k	1/16W	5%	RMC1/16S 223JTH	J24189041		3-	A	C5
R 1006	CHIP RES.	470k	1/16W	5%	RMC1/16S 474JTH	J24189057		1-	A	C5
R 1007	CHIP RES.	100	1W	5%	RMC1 101JTE	J24305101		1-	A	G3
R 1008	CHIP RES.	470k	1/16W	5%	RMC1/16S 474JTH	J24189057		1-	A	C4
R 1009	CHIP RES.	470k	1/16W	5%	RMC1/16S 474JTH	J24189057		1-	A	C4
R 1009	CHIP RES.	270k	1/16W	5%	RMC1/16S 274JTH	J24189054		3-	A	C4

✖: Please contact Vertex Standard

MAIN Unit

Parts List

REF	DESCRIPTION	VALUE	V/W	TOL.	MFR'S DESIG	VXSTD P/N	VERS.	LOT	SIDE	LAY ADR
R 1010	CHIP RES.	100k	1/16W	5%	RMC1/16S 104JTH	J24189049		1-	B	a3
R 1011	CHIP RES.	0	1/16W	5%	RMC1/16S JPTH	J24189070		1-	A	I2
R 1012	CHIP RES.	100	1/4W	5%	RMC1/4 101JATP	J24245101		1-	A	H2
R 1013	CHIP RES.	10k	1/16W	5%	RMC1/16S 103JTH	J24189037		1-	A	C5
R 1014	CHIP RES.	4.7k	1/16W	5%	RMC1/16S 472JTH	J24189033		1-	A	C4
R 1015	CHIP RES.	10k	1/16W	5%	RMC1/16S 103JTH	J24189037		1-	B	i3
R 1016	CHIP RES.	0	1/16W	5%	RMC1/16S JPTH	J24189070		1-	A	H2
R 1017	CHIP RES.	27k	1/16W	5%	RMC1/16S 273JTH	J24189042		1-	B	i3
R 1018	CHIP RES.	100k	1/16W	5%	RMC1/16S 104JTH	J24189049		1-	B	a3
R 1019	CHIP RES.	560	1/16W	5%	RMC1/16S 561JTH	J24189022		1-	A	B2
R 1021	CHIP RES.	100	1/4W	5%	RMC1/4 101JATP	J24245101		1-	A	H2
R 1022	CHIP RES.	270k	1/16W	5%	RMC1/16S 274JTH	J24189054		1-	A	D5
R 1023	CHIP RES.	120k	1/16W	5%	RMC1/16S 124JTH	J24189050		1-	A	E5
R 1024	CHIP RES.	3.3k	1/16W	5%	RMC1/16S 332JTH	J24189031		1-	A	H3
R 1025	CHIP RES.	100k	1/16W	5%	RMC1/16S 104JTH	J24189049		1-	A	E5
R 1026	CHIP RES.	3.3k	1/16W	5%	RMC1/16S 332JTH	J24189031		1-8	A	I2
R 1026	CHIP RES.	1k	1/16W	5%	RMC1/16S 102JTH	J24189025	25W	9-	A	I2
R 1026	CHIP RES.	3.3k	1/16W	5%	RMC1/16S 332JTH	J24189031	50W	9-	A	I2
R 1027	CHIP RES.	3.3k	1/16W	5%	RMC1/16S 332JTH	J24189031		1-	A	H3
R 1027	CHIP RES.	2.7k	1/16W	5%	RMC1/16S 272JTH	J24189030		3-8	A	H3
R 1027	CHIP RES.	10k	1/16W	5%	RMC1/16S 103JTH	J24189037	25W	9-	A	H3
R 1027	CHIP RES.	2.7k	1/16W	5%	RMC1/16S 272JTH	J24189030	50W	9-	A	H3
R 1028	CHIP RES.	3.3k	1/16W	5%	RMC1/16S 332JTH	J24189031		1-	A	I2
R 1028	CHIP RES.	2.7k	1/16W	5%	RMC1/16S 272JTH	J24189030		5-8	A	I2
R 1028	CHIP RES.	10k	1/16W	5%	RMC1/16S 103JTH	J24189037	25W	9-	A	I2
R 1028	CHIP RES.	2.7k	1/16W	5%	RMC1/16S 272JTH	J24189030	50W	9-	A	I2
R 1029	CHIP RES.	220k	1/16W	5%	RMC1/16S 224JTH	J24189053		1-8	A	I2
R 1029	CHIP RES.	100k	1/16W	5%	RMC1/16S 104JTH	J24189049	25W	9-	A	I2
R 1029	CHIP RES.	220k	1/16W	5%	RMC1/16S 224JTH	J24189053	50W	9-	A	I2
R 1030	CHIP RES.	0	1/16W	5%	RMC1/16S JPTH	J24189070		1-	A	J2
R 1031	CHIP RES.	4.7k	1/16W	5%	RMC1/16S 472JTH	J24189033		1-	B	b3
R 1032	CHIP RES.	10k	1/16W	5%	RMC1/16S 103JTH	J24189037		1-	B	b3
R 1033	CHIP RES.	4.7k	1/16W	5%	RMC1/16S 472JTH	J24189033		1-8	B	b3
R 1033	CHIP RES.	3.3k	1/16W	5%	RMC1/16S 332JTH	J24189031	W/ CE	9-	B	b3
R 1033	CHIP RES.	4.7k	1/16W	5%	RMC1/16S 472JTH	J24189033	W/O CE	9-	B	b3
R 1034	CHIP RES.	0	1/16W	5%	RMC1/16 000JATP	J24185000		1-	A	D5
R 1035	CHIP RES.	100k	1/16W	5%	RMC1/16S 104JTH	J24189049		1-	A	K2
R 1036	CHIP RES.	15k	1/16W	5%	RMC1/16S 153JTH	J24189039		1-	A	E5
R 1036	CHIP RES.	8.2k	1/16W	5%	RMC1/16S 822JTH	J24189036		3-10	A	E5
R 1036	CHIP RES.	10k	1/16W	5%	RMC1/16S 103JTH	J24189037	CHINA	11-	A	E5
R 1036	CHIP RES.	8.2k	1/16W	5%	RMC1/16S 822JTH	J24189036	EUROPE	11-	A	E5
R 1036	CHIP RES.	8.2k	1/16W	5%	RMC1/16S 822JTH	J24189036	EXPORT	11-	A	E5
R 1036	CHIP RES.	8.2k	1/16W	5%	RMC1/16S 822JTH	J24189036	VTX(USA)	11-	A	E5
R 1037	CHIP RES.	220k	1/16W	5%	RMC1/16S 224JTH	J24189053		1-	A	G5
R 1038	CHIP RES.	0	1/16W	5%	RMC1/16S JPTH	J24189070		1-	A	G5
R 1039	CHIP RES.	100	1/16W	5%	RMC1/16S 101JTH	J24189013		1-8	B	b3
R 1039	CHIP RES.	47	1/16W	5%	RMC1/16S 470JTH	J24189009	W/ CE	9-	B	b3
R 1039	CHIP RES.	100	1/16W	5%	RMC1/16S 101JTH	J24189013	W/O CE	9-	B	b3
R 1041	CHIP RES.	150k	1/16W	5%	RMC1/16S 154JTH	J24189051		1-	A	J2
R 1041	CHIP RES.	100k	1/16W	5%	RMC1/16S 104JTH	J24189049		7-	A	J2
R 1042	CHIP RES.	22k	1/16W	5%	RMC1/16S 223JTH	J24189041		1-	B	h2
R 1043	CHIP RES.	5.6k	1/16W	5%	RMC1/16S 562JTH	J24189034		1-	A	E5
R 1044	CHIP RES.	10k	1/16W	5%	RMC1/16S 103JTH	J24189037		1-	A	G4
R 1045	CHIP RES.	10k	1/16W	5%	RMC1/16S 103JTH	J24189037		1-	B	h2
R 1047	CHIP RES.	47	1/16W	5%	RMC1/16S 470JTH	J24189009		1-	B	b3
R 1048	CHIP RES.	100k	1/16W	5%	RMC1/16S 104JTH	J24189049		1-	A	G5
R 1049	CHIP RES.	22k	1/16W	5%	RMC1/16S 223JTH	J24189041		1-	A	F3
R 1050	CHIP RES.	330	1/16W	5%	RMC1/16S 331JTH	J24189019		1-	B	f2
R 1051	CHIP RES.	39k	1/16W	5%	RMC1/16S 393JTH	J24189044		1-	A	G5
R 1052	CHIP RES.	560k	1/16W	5%	RMC1/16S 564JTH	J24189058		1-	A	E5
R 1052	CHIP RES.	180k	1/16W	5%	RMC1/16S 184JTH	J24189052		3-	A	E5
R 1052	CHIP RES.	220k	1/16W	5%	RMC1/16S 224JTH	J24189053		5-10	A	E5
R 1052	CHIP RES.	330k	1/16W	5%	RMC1/16S 334JTH	J24189055	CHINA	11-	A	E5
R 1052	CHIP RES.	220k	1/16W	5%	RMC1/16S 224JTH	J24189053	EUROPE	11-	A	E5
R 1052	CHIP RES.	220k	1/16W	5%	RMC1/16S 224JTH	J24189053	EXPORT	11-	A	E5
R 1052	CHIP RES.	220k	1/16W	5%	RMC1/16S 224JTH	J24189053	VTX(USA)	11-	A	E5
R 1053	CHIP RES.	0	1/16W	5%	RMC1/16 000JATP	J24185000		1-	A	B5
R 1054	CHIP RES.	18	1/16W	5%	RMC1/16S 180JTH	J24189004		1-	B	f2
R 1054	CHIP RES.	100	1/16W	5%	RMC1/16S 101JTH	J24189013		5-	B	f2
R 1054	CHIP RES.	33	1/16W	5%	RMC1/16S 330JTH	J24189007		7-8	B	f2
R 1054	CHIP RES.	56	1/16W	5%	RMC1/16S 560JTH	J24189010	W/ CE	9-	B	f2
R 1054	CHIP RES.	33	1/16W	5%	RMC1/16S 330JTH	J24189007	W/O CE	9-	B	f2
R 1057	CHIP RES.	1M	1/16W	5%	RMC1/16S 105JTH	J24189061		1-	A	G4

MAIN Unit

Parts List

REF	DESCRIPTION	VALUE	V/W	TOL.	MFR'S DESIG	VXSTD P/N	VERS.	LOT	SIDE	LAY ADR
R 1058	CHIP RES.	100k	1/16W	5%	RMC1/16S 104JTH	J24189049		1-8	A	J2
R 1058	CHIP RES.	47k	1/16W	5%	RMC1/16S 473JTH	J24189045	25W	9-	A	J2
R 1058	CHIP RES.	100k	1/16W	5%	RMC1/16S 104JTH	J24189049	50W	9-	A	J2
R 1059	CHIP RES.	1k	1/16W	5%	RMC1/16S 102JTH	J24189025		1-	A	F3
R 1060	CHIP RES.	330	1/16W	5%	RMC1/16S 331JTH	J24189019		1-	B	f2
R 1061	CHIP RES.	2.2k	1/16W	5%	RMC1/16S 222JTH	J24189029		1-	A	K2
R 1063	CHIP RES.	10k	1/16W	5%	RMC1/16S 103JTH	J24189037		1-	A	E5
R 1065	CHIP RES.	100k	1/16W	5%	RMC1/16S 104JTH	J24189049		1-	A	J2
R 1066	CHIP RES.	0	1/16W	5%	RMC1/16S JPTH	J24189070		1-	A	F5
R 1067	CHIP RES.	10k	1/16W	5%	RMC1/16S 103JTH	J24189037		1-	A	H5
R 1068	CHIP RES.	100k	1/16W	5%	RMC1/16S 104JTH	J24189049		1-	A	J2
R 1069	CHIP RES.	56k	1/16W	5%	RMC1/16S 563JTH	J24189046		1-	A	K2
R 1070	CHIP RES.	39k	1/16W	5%	RMC1/16S 393JTH	J24189044		1-	A	G4
R 1071	CHIP RES.	47k	1/16W	5%	RMC1/16S 473JTH	J24189045		1-	A	B5
R 1072	CHIP RES.	47k	1/16W	5%	RMC1/16S 473JTH	J24189045		1-	A	F3
R 1073	CHIP RES.	10k	1/16W	5%	RMC1/16S 103JTH	J24189037		1-	A	G5
R 1074	CHIP RES.	100k	1/16W	5%	RMC1/16S 104JTH	J24189049		1-	A	F3
R 1075	CHIP RES.	27k	1/16W	5%	RMC1/16S 273JTH	J24189042		1-	A	I5
R 1076	CHIP RES.	47k	1/16W	5%	RMC1/16S 473JTH	J24189045		1-	A	B5
R 1077	CHIP RES.	68	1/4W	5%	RMC1/4 680JATP	J24245680		1-	B	f2
R 1078	CHIP RES.	0	1/16W	5%	RMC1/16S JPTH	J24189070		1-	A	G5
R 1079	CHIP RES.	47k	1/16W	5%	RMC1/16S 473JTH	J24189045		1-	A	B5
R 1080	CHIP RES.	5.6k	1/16W	5%	RMC1/16S 562JTH	J24189034		1-	A	I4
R 1081	CHIP RES.	10k	1/16W	5%	RMC1/16S 103JTH	J24189037		1-	B	f2
R 1082	CHIP RES.	2.2M	1/16W	5%	RMC1/16S 225JTH	J24189065	25W	9-	A	J2
R 1083	CHIP RES.	0	1/16W	5%	RMC1/16 000JATP	J24185000		1-	A	F3
R 1084	CHIP RES.	47k	1/16W	5%	RMC1/16S 473JTH	J24189045		1-	B	i5
R 1085	CHIP RES.	2.2k	1/16W	5%	RMC1/16S 222JTH	J24189029		1-	A	I5
R 1086	CHIP RES.	0	1/16W	5%	RMC1/16S JPTH	J24189070		1-	A	F5
R 1087	CHIP RES.	8.2k	1/16W	5%	RMC1/16S 822JTH	J24189036		1-	A	I5
R 1088	CHIP RES.	1k	1/16W	5%	RMC1/16S 102JTH	J24189025		1-	A	J2
R 1089	CHIP RES.	10k	1/16W	5%	RMC1/16S 103JTH	J24189037		1-	A	H4
R 1090	CHIP RES.	10k	1/16W	5%	RMC1/16S 103JTH	J24189037		1-	A	H4
R 1091	CHIP RES.	10k	1/16W	5%	RMC1/16S 103JTH	J24189037		1-	A	F3
R 1092	CHIP RES.	150	1/16W	5%	RMC1/16S 151JTH	J24189015		1-	B	e2
R 1093	CHIP RES.	470	1/16W	5%	RMC1/16S 471JTH	J24189021		1-	B	f2
R 1094	CHIP RES.	10k	1/16W	5%	RMC1/16S 103JTH	J24189037		1-	A	F4
R 1094	CHIP RES.	22k	1/16W	5%	RMC1/16S 223JTH	J24189041		3-	A	F4
R 1095	CHIP RES.	33k	1/16W	5%	RMC1/16S 333JTH	J24189043		1-	A	E5
R 1096	CHIP RES.	100k	1/16W	5%	RMC1/16S 104JTH	J24189049		1-	A	E5
R 1097	CHIP RES.	18k	1/16W	5%	RMC1/16S 183JTH	J24189040		1-	B	j5
R 1098	CHIP RES.	10k	1/16W	5%	RMC1/16S 103JTH	J24189037		1-	B	i5
R 1099	CHIP RES.	470	1/16W	5%	RMC1/16S 471JTH	J24189021		1-	B	e2
R 1101	CHIP RES.	10k	1/16W	5%	RMC1/16S 103JTH	J24189037		1-	B	i5
R 1102	CHIP RES.	0	1/16W	5%	RMC1/16S JPTH	J24189070		1-	B	c3
R 1103	CHIP RES.	22k	1/16W	5%	RMC1/16S 223JTH	J24189041		1-	A	I5
R 1104	CHIP RES.	10k	1/16W	5%	RMC1/16S 103JTH	J24189037		1-	A	J3
R 1106	CHIP RES.	47k	1/16W	5%	RMC1/16S 473JTH	J24189045		1-	B	i5
R 1108	CHIP RES.	0	1/16W	5%	RMC1/16S JPTH	J24189070		1-	A	F5
R 1109	CHIP RES.	10k	1/16W	5%	RMC1/16S 103JTH	J24189037		1-	B	i5
R 1110	CHIP RES.	39k	1/16W	5%	RMC1/16S 393JTH	J24189044		1-	A	E5
R 1110	CHIP RES.	27k	1/16W	5%	RMC1/16S 273JTH	J24189042		5-	A	E5
R 1112	CHIP RES.	15k	1/16W	5%	RMC1/16S 153JTH	J24189039		1-	A	I5
R 1113	CHIP RES.	39k	1/16W	5%	RMC1/16S 393JTH	J24189044		1-	A	E5
R 1114	CHIP RES.	100	1/16W	5%	RMC1/16S 101JTH	J24189013		1-	B	e2
R 1115	CHIP RES.	100k	1/16W	5%	RMC1/16S 104JTH	J24189049		1-	A	F4
R 1116	CHIP RES.	150k	1/16W	5%	RMC1/16S 154JTH	J24189051		1-	A	F4
R 1117	CHIP RES.	4.7k	1/16W	5%	RMC1/16S 472JTH	J24189033		1-	A	J3
R 1118	CHIP RES.	6.8k	1/16W	5%	RMC1/16S 682JTH	J24189035		1-	A	J2
R 1119	CHIP RES.	47k	1/16W	5%	RMC1/16S 473JTH	J24189045		1-	B	e2
R 1120	CHIP RES.	4.7k	1/16W	5%	RMC1/16S 472JTH	J24189033		1-	A	J3
R 1122	CHIP RES.	82k	1/16W	5%	RMC1/16S 823JTH	J24189048		1-	A	H3
R 1123	CHIP RES.	10k	1/16W	5%	RMC1/16S 103JTH	J24189037		1-	A	I5
R 1125	CHIP RES.	10k	1/16W	5%	RMC1/16S 103JTH	J24189037		1-	A	J3
R 1126	CHIP RES.	10k	1/16W	5%	RMC1/16S 103JTH	J24189037		1-8	A	J3
R 1126	CHIP RES.	8.2k	1/16W	5%	RMC1/16S 822JTH	J24189036	25W	9-	A	J3
R 1126	CHIP RES.	10k	1/16W	5%	RMC1/16S 103JTH	J24189037	50W	9-	A	J3
R 1127	CHIP RES.	2.2k	1/16W	5%	RMC1/16S 222JTH	J24189029		1-	B	i5
R 1129	CHIP RES.	100k	1/16W	5%	RMC1/16S 104JTH	J24189049		1-	A	H3
R 1130	CHIP RES.	100	1/16W	5%	RMC1/16S 101JTH	J24189013		1-	B	e2
R 1131	CHIP RES.	18	1/16W	5%	RMC1/16S 180JTH	J24189004		1-	B	e2
R 1132	CHIP RES.	22k	1/16W	5%	RMC1/16S 223JTH	J24189041		1-	A	H5
R 1133	CHIP RES.	82k	1/16W	5%	RMC1/16S 823JTH	J24189048		1-	B	e2

MAIN Unit

Parts List

REF	DESCRIPTION	VALUE	V/W	TOL.	MFR'S DESIG	VXSTD P/N	VERS.	LOT	SIDE	LAY ADR
R 1135	CHIP RES.	100k	1/16W	5%	RMC1/16S 104JTH	J24189049		1-	A	H3
R 1136	CHIP RES.	100k	1/16W	5%	RMC1/16S 104JTH	J24189049		1-	A	H3
R 1137	CHIP RES.	100	1/16W	5%	RMC1/16S 101JTH	J24189013		1-	A	E3
R 1138	CHIP RES.	1k	1/16W	5%	RMC1/16S 102JTH	J24189025		1-	B	d3
R 1139	CHIP RES.	100	1/16W	5%	RMC1/16S 101JTH	J24189013		1-	A	H3
R 1140	CHIP RES.	1k	1/16W	5%	RMC1/16S 102JTH	J24189025		1-	B	e3
R 1141	CHIP RES.	3.9k	1/16W	5%	RMC1/16S 392JTH	J24189032		1-	B	e2
R 1142	CHIP RES.	560	1/16W	5%	RMC1/16S 561JTH	J24189022		1-	B	e3
R 1143	CHIP RES.	0	1/16W	5%	RMC1/16S JPTH	J24189070		1-	B	e3
R 1144	CHIP RES.	33k	1/16W	5%	RMC1/16S 333JTH	J24189043		1-	B	e3
R 1145	CHIP RES.	150k	1/16W	5%	RMC1/16S 154JTH	J24189051		1-	A	H4
R 1146	CHIP RES.	150k	1/16W	5%	RMC1/16S 154JTH	J24189051		1-	A	H4
R 1149	CHIP RES.	47	1/16W	5%	RMC1/16S 470JTH	J24189009		1-	A	H4
R 1150	CHIP RES.	47	1/16W	5%	RMC1/16S 470JTH	J24189009		1-	A	H4
R 1151	CHIP RES.	15k	1/16W	5%	RMC1/16S 153JTH	J24189039		1-	B	e3
R 1152	CHIP RES.	22	1/16W	5%	RMC1/16S 220JTH	J24189005		1-	B	d4
R 1153	CHIP RES.	220k	1/16W	5%	RMC1/16S 224JTH	J24189053		1-	A	D4
R 1154	CHIP RES.	18k	1/16W	5%	RMC1/16S 183JTH	J24189040		1-	B	f5
R 1155	CHIP RES.	270	1/16W	5%	RMC1/16S 271JTH	J24189018		1-	B	f3
R 1155	CHIP RES.	270	1/16W	0.5%	MHR01MZPD2700	J24189427		7-	B	f3
R 1156	CHIP RES.	68k	1/16W	5%	RMC1/16S 683JTH	J24189047		1-	A	H5
R 1156	CHIP RES.	82k	1/16W	5%	RMC1/16S 823JTH	J24189048		5-10	A	H5
R 1156	CHIP RES.	68k	1/16W	5%	RMC1/16S 683JTH	J24189047		11-	A	H5
R 1156	CHIP RES.	82k	1/16W	5%	RMC1/16S 823JTH	J24189048		11-	A	H5
R 1156	CHIP RES.	82k	1/16W	5%	RMC1/16S 823JTH	J24189048		11-	A	H5
R 1156	CHIP RES.	82k	1/16W	5%	RMC1/16S 823JTH	J24189048		11-	A	H5
R 1157	CHIP RES.	0	1/16W	5%	RMC1/16S JPTH	J24189070		1-	A	E4
R 1158	CHIP RES.	1M	1/16W	5%	RMC1/16S 105JTH	J24189061		1-	A	D4
R 1159	CHIP RES.	180k	1/16W	5%	RMC1/16S 184JTH	J24189052		1-	A	H5
R 1160	CHIP RES.	100	1/16W	5%	RMC1/16S 101JTH	J24189013		1-	B	f3
R 1160	CHIP RES.	100	1/16W	0.5%	MHR01MZPD1000	J24189422		8-	B	f3
R 1161	CHIP RES.	33k	1/16W	5%	RMC1/16S 333JTH	J24189043		1-	A	D5
R 1162	CHIP RES.	220k	1/16W	5%	RMC1/16S 224JTH	J24189053		1-	A	D5
R 1163	CHIP RES.	47	1/16W	5%	RMC1/16S 470JTH	J24189009		1-	B	e3
R 1164	CHIP RES.	3.3k	1/16W	5%	RMC1/16S 332JTH	J24189031		1-	B	e3
R 1164	CHIP RES.	3.3k	1/16W	0.5%	MHR01MZPD3301	J24189440		7-	B	e3
R 1165	CHIP RES.	1k	1/16W	5%	RMC1/16S 102JTH	J24189025		1-	B	f3
R 1165	CHIP RES.	1k	1/16W	0.5%	MHR01MZPD1001	J24189434		8-	B	f3
R 1166	CHIP RES.	560	1/16W	5%	RMC1/16S 561JTH	J24189022		1-	A	G5
R 1167	CHIP RES.	330k	1/16W	5%	RMC1/16S 334JTH	J24189055		1-	A	H5
R 1168	CHIP RES.	5.6k	1/16W	5%	RMC1/16S 562JTH	J24189034		1-	B	e4
R 1168	CHIP RES.	5.6k	1/16W	0.5%	MHR01MZPD5601	J24189443		7-	B	e4
R 1170	CHIP RES.	390	1/16W	5%	RMC1/16S 391JTH	J24189020		1-	A	I4
R 1171	CHIP RES.	100k	1/16W	5%	RMC1/16S 104JTH	J24189049		1-	A	G5
R 1172	CHIP RES.	47k	1/16W	5%	RMC1/16S 473JTH	J24189045		1-	B	c4
R 1173	CHIP RES.	100k	1/16W	5%	RMC1/16S 104JTH	J24189049		1-	A	G5
R 1174	CHIP RES.	10k	1/16W	5%	RMC1/16S 103JTH	J24189037		1-	A	E5
R 1175	CHIP RES.	220k	1/16W	5%	RMC1/16S 224JTH	J24189053		1-	A	H5
R 1176	CHIP RES.	150	1/16W	5%	RMC1/16S 151JTH	J24189015		1-	B	c4
R 1177	CHIP RES.	470	1/16W	5%	RMC1/16S 471JTH	J24189021		1-	B	b4
R 1178	CHIP RES.	2.2k	1/16W	5%	RMC1/16S 222JTH	J24189029		1-	B	f3
R 1179	CHIP RES.	100k	1/16W	5%	RMC1/16S 104JTH	J24189049		1-10	A	H5
R 1179	CHIP RES.	56k	1/16W	5%	RMC1/16S 563JTH	J24189046		11-	A	H5
R 1179	CHIP RES.	100k	1/16W	5%	RMC1/16S 104JTH	J24189049		11-	A	H5
R 1179	CHIP RES.	100k	1/16W	5%	RMC1/16S 104JTH	J24189049		11-	A	H5
R 1179	CHIP RES.	100k	1/16W	5%	RMC1/16S 104JTH	J24189049		11-	A	H5
R 1180	CHIP RES.	10k	1/16W	5%	RMC1/16S 103JTH	J24189037		1-	A	E5
R 1181	CHIP RES.	270	1/16W	5%	RMC1/16S 271JTH	J24189018		1-	B	c4
R 1182	CHIP RES.	4.7k	1/16W	5%	RMC1/16S 472JTH	J24189033		1-	A	E3
R 1183	CHIP RES.	10k	1/16W	5%	RMC1/16S 103JTH	J24189037		1-	A	C4
R 1184	CHIP RES.	10k	1/16W	5%	RMC1/16S 103JTH	J24189037		1-	A	C4
R 1185	CHIP RES.	10k	1/16W	5%	RMC1/16S 103JTH	J24189037		1-	A	H5
R 1186	CHIP RES.	680k	1/16W	5%	RMC1/16S 684JTH	J24189059		1-	B	c5
R 1187	CHIP RES.	470k	1/16W	5%	RMC1/16S 474JTH	J24189057		1-	A	G5
R 1188	CHIP RES.	4.7M	1/16W	5%	RMC1/16S 475JTH	J24189337		1-	A	H5
R 1188	CHIP RES.	3.3M	1/16W	5%	RMC1/16S 335JTH	J24189324		5-	A	H5
R 1189	CHIP RES.	100k	1/16W	5%	RMC1/16S 104JTH	J24189049		1-	A	I5
R 1191	CHIP RES.	1.2k	1/16W	5%	RMC1/16S 122JTH	J24189026		1-	B	e3
R 1192	CHIP RES.	22k	1/16W	5%	RMC1/16S 223JTH	J24189041		1-	A	G5
R 1193	CHIP RES.	10k	1/16W	5%	RMC1/16S 103JTH	J24189037		1-	B	h4
R 1194	CHIP RES.	82k	1/16W	5%	RMC1/16S 823JTH	J24189048		1-	A	I5
R 1195	CHIP RES.	22	1/16W	5%	RMC1/16S 220JTH	J24189005		1-	B	f4
R 1196	CHIP RES.	47k	1/16W	5%	RMC1/16S 473JTH	J24189045		1-	A	D4

CHINA
EUROPE
EXPORT
VTX(USA)

MAIN Unit

Parts List

REF	DESCRIPTION	VALUE	V/W	TOL.	MFR'S DESIG	VXSTD P/N	VERS.	LOT	SIDE	LAY ADR
R 1198	CHIP RES.	68k	1/16W	5%	RMC1/16S 683JTH	J24189047		1-	A	H5
R 1198	CHIP RES.	82k	1/16W	5%	RMC1/16S 823JTH	J24189048		5-	A	H5
R 1199	CHIP RES.	47k	1/16W	5%	RMC1/16S 473JTH	J24189045		1-	A	D4
R 1200	CHIP RES.	0	1/16W	5%	RMC1/16S JPTH	J24189070		1-	A	H5
R 1201	CHIP RES.	10k	1/16W	5%	RMC1/16S 103JTH	J24189037		1-	A	H5
R 1202	CHIP RES.	15k	1/16W	5%	RMC1/16S 153JTH	J24189039		1-	A	H5
R 1203	CHIP RES.	10k	1/16W	5%	RMC1/16S 103JTH	J24189037		1-	A	G5
R 1204	CHIP RES.	47k	1/16W	5%	RMC1/16S 473JTH	J24189045		1-	A	D4
R 1205	CHIP RES.	47k	1/16W	5%	RMC1/16S 473JTH	J24189045		1-	A	D4
R 1206	CHIP RES.	470	1/16W	5%	RMC1/16S 471JTH	J24189021		1-	A	G4
R 1207	CHIP RES.	12k	1/16W	5%	RMC1/16S 123JTH	J24189038		1-	B	a4
R 1208	CHIP RES.	10k	1/16W	5%	RMC1/16S 103JTH	J24189037		1-	B	e4
R 1209	CHIP RES.	1.5k	1/16W	5%	RMC1/16S 152JTH	J24189027		1-	B	e4
R 1210	CHIP RES.	3.3k	1/16W	5%	RMC1/16S 332JTH	J24189031		1-	B	b4
R 1211	CHIP RES.	0	1/16W	5%	RMC1/16S JPTH	J24189070		1-	B	e4
R 1212	CHIP RES.	150k	1/16W	5%	RMC1/16S 154JTH	J24189051		1-	A	J5
R 1213	CHIP RES.	1k	1/16W	5%	RMC1/16S 102JTH	J24189025		1-	A	F3
R 1215	CHIP RES.	2.2k	1/16W	5%	RMC1/16S 222JTH	J24189029		1-	A	D4
R 1216	CHIP RES.	1.8k	1/16W	5%	RMC1/16S 182JTH	J24189028		1-	A	C4
R 1217	CHIP RES.	12k	1/16W	5%	RMC1/16S 123JTH	J24189038		1-	B	a4
R 1218	CHIP RES.	1.5k	1/16W	5%	RMC1/16S 152JTH	J24189027		1-	B	d4
R 1219	CHIP RES.	2.2k	1/16W	5%	RMC1/16S 222JTH	J24189029		1-	A	l4
R 1220	CHIP RES.	1k	1/16W	5%	RMC1/16S 102JTH	J24189025		1-	B	e3
R 1221	CHIP RES.	10k	1/16W	5%	RMC1/16S 103JTH	J24189037		1-	A	E3
R 1222	CHIP RES.	0	1/16W	5%	RMC1/16 000JATP	J24185000		1-	A	B2
R 1223	CHIP RES.	1M	1/16W	5%	RMC1/16S 105JTH	J24189061		1-	B	d4
R 1224	CHIP RES.	330k	1/16W	5%	RMC1/16S 334JTH	J24189055		1-	B	i4
R 1225	CHIP RES.	1k	1/16W	5%	RMC1/16S 102JTH	J24189025		1-	B	b4
R 1226	CHIP RES.	220	1/16W	5%	RMC1/16S 221JTH	J24189017		5-	B	b4
R 1227	CHIP RES.	12k	1/16W	5%	RMC1/16S 123JTH	J24189038		1-	B	a4
R 1228	CHIP RES.	0	1/16W	5%	RMC1/16S JPTH	J24189070		1-	B	d4
R 1229	CHIP RES.	100k	1/16W	5%	RMC1/16S 104JTH	J24189049		1-	A	l5
R 1230	CHIP RES.	100k	1/16W	5%	RMC1/16S 104JTH	J24189049		1-	A	l5
R 1231	CHIP RES.	15k	1/16W	5%	RMC1/16S 153JTH	J24189039		1-	B	j4
R 1232	CHIP RES.	22k	1/16W	5%	RMC1/16S 223JTH	J24189041		1-	B	j4
R 1233	CHIP RES.	4.7k	1/16W	5%	RMC1/16S 472JTH	J24189033		1-	A	F3
R 1234	CHIP RES.	82k	1/16W	5%	RMC1/16S 823JTH	J24189048		1-	B	i4
R 1235	CHIP RES.	0	1/16W	5%	RMC1/16 000JATP	J24185000		1-	A	B2
R 1236	CHIP RES.	6.8k	1/16W	5%	RMC1/16S 682JTH	J24189035		1-	B	b4
R 1237	CHIP RES.	22	1/16W	5%	RMC1/16S 220JTH	J24189005		1-	B	d3
R 1238	CHIP RES.	47k	1/16W	5%	RMC1/16S 473JTH	J24189045		1-	A	D3
R 1239	CHIP RES.	12k	1/16W	5%	RMC1/16S 123JTH	J24189038		1-	B	a4
R 1240	CHIP RES.	47k	1/16W	5%	RMC1/16S 473JTH	J24189045		1-	B	e4
R 1243	CHIP RES.	12k	1/16W	5%	RMC1/16S 123JTH	J24189038		1-	B	a4
R 1244	CHIP RES.	22k	1/16W	5%	RMC1/16S 223JTH	J24189041		1-	B	j4
R 1245	CHIP RES.	100k	1/16W	5%	RMC1/16S 104JTH	J24189049		1-	B	j4
R 1246	CHIP RES.	150k	1/16W	5%	RMC1/16S 154JTH	J24189051		1-	B	b4
R 1247	CHIP RES.	3.3k	1/16W	5%	RMC1/16S 332JTH	J24189031		1-	A	F3
R 1248	CHIP RES.	0	1/16W	5%	RMC1/16 000JATP	J24185000		1-	A	A2
R 1249	CHIP RES.	180k	1/16W	5%	RMC1/16S 184JTH	J24189052		1-	B	e4
R 1250	CHIP RES.	10k	1/16W	5%	RMC1/16S 103JTH	J24189037		1-	B	d4
R 1251	CHIP RES.	1k	1/16W	5%	RMC1/16S 102JTH	J24189025		1-	B	d3
R 1252	CHIP RES.	0	1/16W	5%	RMC1/16 000JATP	J24185000		1-	A	B1
R 1253	CHIP RES.	22	1/16W	5%	RMC1/16S 220JTH	J24189005		1-	A	l4
R 1254	CHIP RES.	470k	1/16W	5%	RMC1/16S 474JTH	J24189057		1-	B	j4
R 1255	CHIP RES.	470k	1/16W	5%	RMC1/16S 474JTH	J24189057		1-	B	j4
R 1256	CHIP RES.	12k	1/16W	5%	RMC1/16S 123JTH	J24189038		1-	B	a4
R 1257	CHIP RES.	0	1/16W	5%	RMC1/16S JPTH	J24189070		1-	A	J5
R 1257	CHIP RES.	10k	1/16W	5%	RMC1/16S 103JTH	J24189037		5-	A	J5
R 1258	CHIP RES.	33k	1/16W	5%	RMC1/16S 333JTH	J24189043		1-	A	J5
R 1259	CHIP RES.	1M	1/16W	5%	RMC1/16S 105JTH	J24189061		1-	A	B4
R 1260	CHIP RES.	47k	1/16W	5%	RMC1/16S 473JTH	J24189045		1-	B	j4
R 1261	CHIP RES.	2.2k	1/16W	5%	RMC1/16S 222JTH	J24189029		1-	B	b4
R 1261	CHIP RES.	330	1/16W	5%	RMC1/16S 331JTH	J24189019		5-	B	b4
R 1262	CHIP RES.	47k	1/16W	5%	RMC1/16S 473JTH	J24189045		1-	A	B3
R 1264	CHIP RES.	0	1/16W	5%	RMC1/16 000JATP	J24185000		1-	A	A2
R 1266	CHIP RES.	47k	1/16W	5%	RMC1/16S 473JTH	J24189045		1-	B	d3
R 1267	CHIP RES.	180	1/16W	5%	RMC1/16S 181JTH	J24189016		1-	B	b5
R 1267	CHIP RES.	150	1/16W	5%	RMC1/16S 151JTH	J24189015		5-	B	b5
R 1268	CHIP RES.	22k	1/16W	5%	RMC1/16S 223JTH	J24189041		1-	A	l5
R 1269	CHIP RES.	0	1/16W	5%	RMC1/16 000JATP	J24185000		1-	A	B1
R 1270	CHIP RES.	22k	1/16W	5%	RMC1/16S 223JTH	J24189041		1-	B	j4
R 1271	CHIP RES.	47k	1/16W	5%	RMC1/16S 473JTH	J24189045		1-	B	i4

MAIN Unit

Parts List

REF	DESCRIPTION	VALUE	V/W	TOL.	MFR'S DESIG	VXSTD P/N	VERS.	LOT	SIDE	LAY ADR
R 1272	CHIP RES.	47k	1/16W	5%	RMC1/16S 473JTH	J24189045		1-	B	i4
R 1273	CHIP RES.	15k	1/16W	5%	RMC1/16S 153JTH	J24189039		1-	B	j4
R 1275	CHIP RES.	390k	1/16W	5%	RMC1/16S 394JTH	J24189056		1-	A	l5
R 1276	CHIP RES.	1k	1/16W	5%	RMC1/16S 102JTH	J24189025		1-	B	j4
R 1277	CHIP RES.	22	1/16W	5%	RMC1/16S 220JTH	J24189005		1-	B	d4
R 1279	CHIP RES.	1k	1/16W	5%	RMC1/16S 102JTH	J24189025		1-	A	B4
R 1280	CHIP RES.	0	1/16W	5%	RMC1/16 000JATP	J24185000		1-	A	A1
R 1281	CHIP RES.	47k	1/16W	5%	RMC1/16S 473JTH	J24189045		1-	A	B4
R 1282	CHIP RES.	150k	1/16W	5%	RMC1/16S 154JTH	J24189051		1-	B	b5
R 1282	CHIP RES.	180k	1/16W	5%	RMC1/16S 184JTH	J24189052		5-	B	b5
R 1283	CHIP RES.	12k	1/16W	5%	RMC1/16S 123JTH	J24189038		1-	B	d4
R 1284	CHIP RES.	470	1/16W	5%	RMC1/16S 471JTH	J24189021		1-	A	B4
R 1285	CHIP RES.	10k	1/16W	5%	RMC1/16S 103JTH	J24189037		1-	B	d4
R 1286	CHIP RES.	470	1/16W	5%	RMC1/16S 471JTH	J24189021		1-	A	B4
R 1288	CHIP RES.	1k	1/16W	5%	RMC1/16S 102JTH	J24189025		1-	B	d3
R 1289	CHIP RES.	2.2k	1/16W	5%	RMC1/16S 222JTH	J24189029		1-	B	b5
R 1290	CHIP RES.	22	1/16W	5%	RMC1/16S 220JTH	J24189005		1-	A	G4
R 1291	CHIP RES.	1k	1/16W	5%	RMC1/16S 102JTH	J24189025		1-	B	d3
R 1292	CHIP RES.	1k	1/16W	5%	RMC1/16S 102JTH	J24189025		1-	B	i4
R 1293	CHIP RES.	1k	1/16W	5%	RMC1/16S 102JTH	J24189025		1-	A	B3
R 1294	CHIP RES.	1k	1/16W	5%	RMC1/16S 102JTH	J24189025		1-	A	B4
R 1296	CHIP RES.	4.7k	1/16W	5%	RMC1/16S 472JTH	J24189033		1-	B	d3
R 1297	CHIP RES.	0	1/16W	5%	RMC1/16 000JATP	J24185000		1-	A	B1
R 1298	CHIP RES.	15k	1/16W	5%	RMC1/16S 153JTH	J24189039		1-	B	c5
R 1299	CHIP RES.	5.6k	1/16W	5%	RMC1/16S 562JTH	J24189034		1-	B	c5
R 1300	CHIP RES.	33k	1/16W	5%	RMC1/16S 333JTH	J24189043		1-	A	l5
R 1301	CHIP RES.	6.8k	1/16W	5%	RMC1/16S 682JTH	J24189035		1-	B	c5
R 1302	CHIP RES.	10k	1/16W	5%	RMC1/16S 103JTH	J24189037		1-	B	b5
R 1303	CHIP RES.	47k	1/16W	5%	RMC1/16S 473JTH	J24189045		1-	A	l5
R 1304	CHIP RES.	680k	1/16W	5%	RMC1/16S 684JTH	J24189059		1-	B	c5
R 1306	CHIP RES.	220k	1/16W	5%	RMC1/16S 224JTH	J24189053		1-	B	c5
R 1306	CHIP RES.	82k	1/16W	5%	RMC1/16S 823JTH	J24189048		3-	B	c5
R 1307	CHIP RES.	100k	1/16W	5%	RMC1/16S 104JTH	J24189049		1-	B	b5
R 1308	CHIP RES.	100k	1/16W	5%	RMC1/16S 104JTH	J24189049		1-	B	c5
R 1309	CHIP RES.	1M	1/16W	5%	RMC1/16S 105JTH	J24189061		1-	B	b5
R 1310	CHIP RES.	5.6k	1/16W	5%	RMC1/16S 562JTH	J24189034		1-	A	l4
R 1311	CHIP RES.	680k	1/16W	5%	RMC1/16S 684JTH	J24189059		1-	B	c5
R 1312	CHIP RES.	680k	1/16W	5%	RMC1/16S 684JTH	J24189059		1-	B	b5
R 1313	CHIP RES.	100k	1/16W	5%	RMC1/16S 104JTH	J24189049		1-	B	c5
R 1313	CHIP RES.	470k	1/16W	5%	RMC1/16S 474JTH	J24189057		3-	B	c5
R 1314	CHIP RES.	27k	1/16W	5%	RMC1/16S 273JTH	J24189042		1-	B	c5
R 1314	CHIP RES.	68k	1/16W	5%	RMC1/16S 683JTH	J24189047		3-	B	c5
R 1315	CHIP RES.	1M	1/16W	5%	RMC1/16S 105JTH	J24189061	CHINA	9-	B	g5
R 1315	CHIP RES.	1M	1/16W	5%	RMC1/16S 105JTH	J24189061	VTX(USA)	9-	B	g5
R 1316	CHIP RES.	27k	1/16W	5%	RMC1/16S 273JTH	J24189042		1-	B	c4
R 1316	CHIP RES.	220k	1/16W	5%	RMC1/16S 224JTH	J24189053		3-	B	c4
R 1317	CHIP RES.	0	1/16W	5%	RMC1/16 000JATP	J24185000		1-	B	i1
R 1317	CHIP RES.	330	1/16W	5%	RMC1/16S 331JTH	J24189019		8	B	i1
R 1317	CHIP RES.	1k	1/16W	5%	RMC1/16 102JATP	J24185102		9-	B	i1
R 1318	CHIP RES.	0	1/16W	5%	RMC1/16 000JATP	J24185000		1-	A	B2
R 1319	CHIP RES.	0	1/16W	5%	RMC1/16 000JATP	J24185000		1-	A	A1
R 1320	CHIP RES.	10k	1/16W	5%	RMC1/16S 103JTH	J24189037		1-	A	C4
R 1321	CHIP RES.	20k	1/16W	0.5%	RR0510R-203-D	J24189150		1-	A	C4
R 1322	CHIP RES.	39k	1/16W	5%	RMC1/16S 393JTH	J24189044		1-	A	C4
R 1323	CHIP RES.	82k	1/16W	5%	RMC1/16S 823JTH	J24189048		1-	A	C4
R 1324	CHIP RES.	0	1/16W	5%	RMC1/16S JPTH	J24189070		1-	A	C3
R 1325	CHIP RES.	0	1/16W	5%	RMC1/16S JPTH	J24189070		1-	A	C4
R 1326	CHIP RES.	10k	1/16W	5%	RMC1/16S 103JTH	J24189037		1-	A	C4
R 1327	CHIP RES.	20k	1/16W	0.5%	RR0510R-203-D	J24189150		1-	A	C4
R 1328	CHIP RES.	39k	1/16W	5%	RMC1/16S 393JTH	J24189044		1-	A	C4
R 1329	CHIP RES.	82k	1/16W	5%	RMC1/16S 823JTH	J24189048		1-	A	C4
R 1330	CHIP RES.	0	1/16W	5%	RMC1/16 000JATP	J24185000		1-	A	B2
R 1331	CHIP RES.	47k	1/16W	5%	RMC1/16S 473JTH	J24189045		1-	A	G5
R 1333	CHIP RES.	47k	1/16W	5%	RMC1/16S 473JTH	J24189045	CHINA	9-	B	f5
R 1333	CHIP RES.	47k	1/16W	5%	RMC1/16S 473JTH	J24189045	VTX(USA)	9-	B	f5
R 1334	CHIP RES.	2.2k	1/16W	5%	RMC1/16S 222JTH	J24189029		1-	A	A5
R 1335	CHIP RES.	47k	1/16W	5%	RMC1/16S 473JTH	J24189045		1-	B	j1
R 1338	CHIP RES.	47k	1/16W	5%	RMC1/16S 473JTH	J24189045		1-	A	l5
R 1339	CHIP RES.	1M	1/16W	5%	RMC1/16S 105JTH	J24189061		1-	A	F4
R 1340	CHIP RES.	1M	1/16W	5%	RMC1/16S 105JTH	J24189061		1-	A	E3
R 1343	CHIP RES.	0	1/16W	5%	RMC1/16S JPTH	J24189070		1-4		
R 1347	CHIP RES.	100k	1/16W	5%	RMC1/16S 104JTH	J24189049		5-	A	E4
R 1348	CHIP RES.	33k	1/16W	5%	RMC1/16S 333JTH	J24189043		5-	A	H5

MAIN Unit

Parts List

REF	DESCRIPTION	VALUE	V/W	TOL.	MFR'S DESIG	VXSTD P/N	VERS.	LOT	SIDE	LAY ADR
R 1349	CHIP RES.	68k	1/16W	5%	RMC1/16S 683JTH	J24189047		5-	A	H5
R 1352	CHIP RES.	330	1/16W	5%	RMC1/16S 331JTH	J24189019		9-	B	i1
R 1353	CHIP RES.	330	1/16W	5%	RMC1/16S 331JTH	J24189019		9-	B	j1
SC1001	SHIELD CASE				(VCO)	RA0790400		1-		
TH1001	THERMISTOR				ERTJ0EV473J	G9090120		1-	B	e2
TH1002	THERMISTOR				ERTJ0EV473J	G9090120		1-	B	c5
VR1001	POT.				RK0971111 20KA/SW	J60800256		1-	A	A5
X 1001	XTAL HC-49SMD	11.0592MHz			FYSMD110592	H0103318		1-	A	A4
X 1002	XTAL OSC	16.8MHz			TTS05VS-P2 16.8MHZ	H9500760		1-	A	G4
X 1003	XTAL U3B	4.194304MHz			4.194304MHZ	H0103284	CHINA	9-	B	g5
X 1003	XTAL U3B	4.194304MHz			4.194304MHZ	H0103284	VTX(USA)	9-	B	g5
XF1001	XTAL FILTER				TF4-67EA1 67.65MHZ	H1102399		1-	A	H4
	LEAF SPRING					RA0824400		1-		
	GROUND PLATE				(L=10)	RA0337900	25W	9-		
	GASKET					RA0896300	25W	9-		

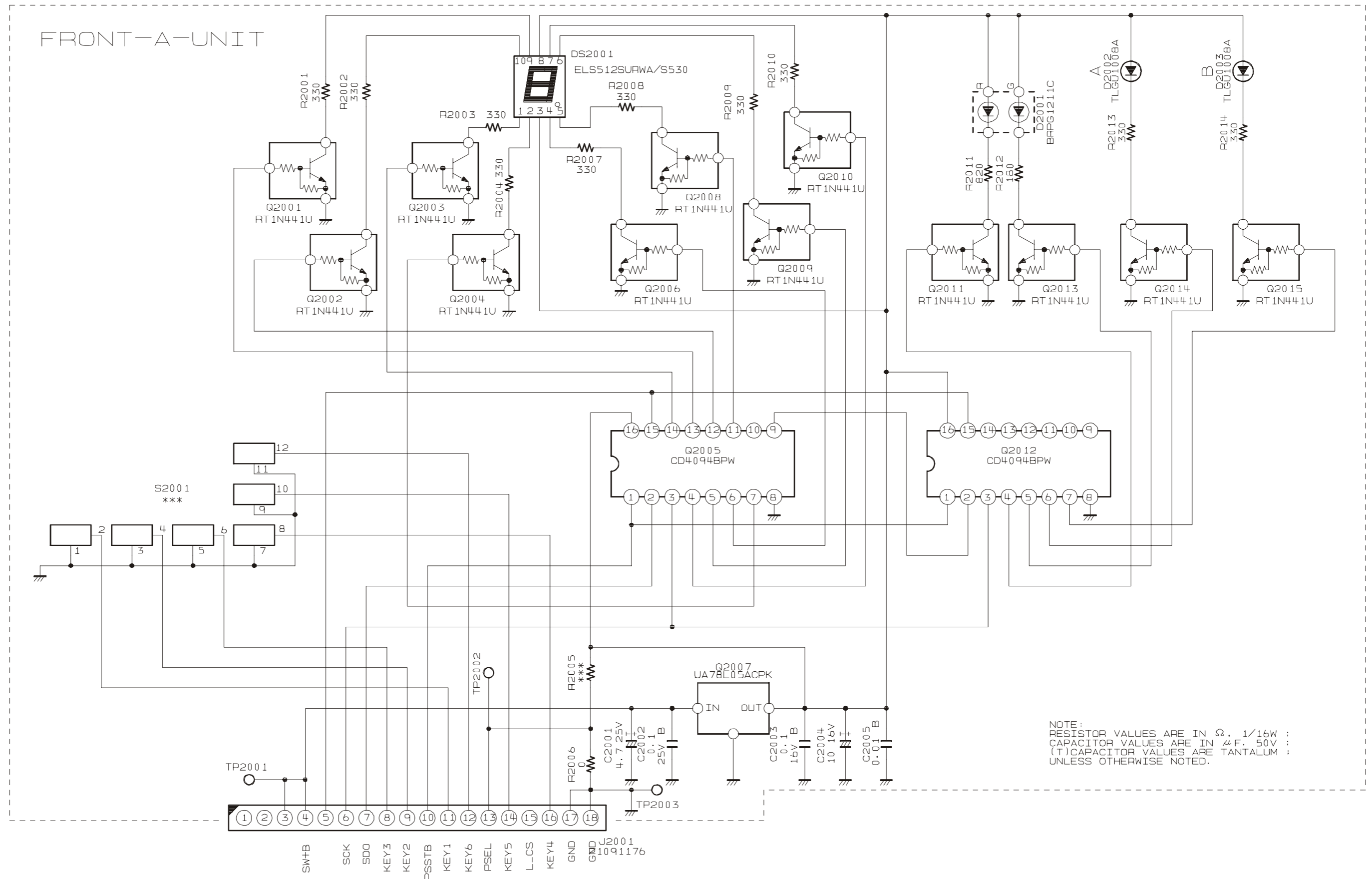

NOTE:
 RESISTOR VALUES ARE IN Ω. 1/16W ;
 CAPACITOR VALUES ARE IN μF. 50V ;
 (T)CAPACITOR VALUES ARE TANTALUM ;
 UNLESS OTHERWISE NOTED.

FRONT-A Unit (VX-2100)

Parts List

REF	DESCRIPTION	VALUE	V/W	TOL.	MFR'S DESIG	VXSTD P/N	VERS.	LOT	SIDE	LAY ADR
PCB with Components						CB3472001				
Printed Circuit Board						FR014510B		1-		
C 2001	CHIP TA.CAP.	4.7uF	25V		TEMSVB21E475M-8R	K78140019		1-	B	e2
C 2002	CHIP CAP.	0.1uF	25V	B	GRM40B104M25PT	K22140811		1-	B	e2
C 2003	CHIP CAP.	0.1uF	16V	B	GRM188B11C104KA01D	K22124805		1-	B	e2
C 2004	CHIP TA.CAP.	10uF	16V		TEMSVB21C106M-8R	K78120025		1-	B	e2
C 2005	CHIP CAP.	0.01uF	50V	B	GRM188B11H103KA01D	K22174823		1-	B	e2
D 2001	LED				BRPG1211C-TR	G2070654		1-	A	B1
D 2002	LED				TLGU1008A(TAPE)	G2070956		1-	A	B1
D 2003	LED				TLGU1008A(TAPE)	G2070956		1-	A	C1
DS2001	LED				ELS-512SURWA/S530-A3	G2090796		1-	A	D1
J 2001	CONNECTOR				18FLT-SM1-TB	P1091176		1-	B	e1
Q 2001	TRANSISTOR				RT1N441U-T11-1	G3070247		1-	B	b1
Q 2002	TRANSISTOR				RT1N441U-T11-1	G3070247		1-	B	c1
Q 2003	TRANSISTOR				RT1N441U-T11-1	G3070247		1-	B	c2
Q 2004	TRANSISTOR				RT1N441U-T11-1	G3070247		1-	B	b2
Q 2005	IC				CD4094BPWR	G1093866		1-	B	b1
Q 2006	TRANSISTOR				RT1N441U-T11-1	G3070247		1-	B	b2
Q 2007	IC				UA78L05ACPK	G1094156		1-	B	e2
Q 2008	TRANSISTOR				RT1N441U-T11-1	G3070247		1-	B	b2
Q 2009	TRANSISTOR				RT1N441U-T11-1	G3070247		1-	B	b1
Q 2010	TRANSISTOR				RT1N441U-T11-1	G3070247		1-	B	b1
Q 2011	TRANSISTOR				RT1N441U-T11-1	G3070247		1-	A	B2
Q 2012	IC				CD4094BPWR	G1093866		1-	B	d2
Q 2013	TRANSISTOR				RT1N441U-T11-1	G3070247		1-	A	B2
Q 2014	TRANSISTOR				RT1N441U-T11-1	G3070247		1-	A	C1
Q 2015	TRANSISTOR				RT1N441U-T11-1	G3070247		1-	A	C2
R 2001	CHIP RES.	330	1/16W	5%	RMC1/16S 331JTH	J24189019		1-	B	c1
R 2002	CHIP RES.	330	1/16W	5%	RMC1/16S 331JTH	J24189019		1-	B	c1
R 2003	CHIP RES.	330	1/16W	5%	RMC1/16S 331JTH	J24189019		1-	B	c2
R 2004	CHIP RES.	330	1/16W	5%	RMC1/16S 331JTH	J24189019		1-	B	c2
R 2006	CHIP RES.	0	1/16W	5%	RMC1/16S JPTH	J24189070		1-	B	f1
R 2007	CHIP RES.	330	1/16W	5%	RMC1/16S 331JTH	J24189019		1-	B	c2
R 2008	CHIP RES.	330	1/16W	5%	RMC1/16S 331JTH	J24189019		1-	B	b2
R 2009	CHIP RES.	330	1/16W	5%	RMC1/16S 331JTH	J24189019		1-	B	b1
R 2010	CHIP RES.	330	1/16W	5%	RMC1/16S 331JTH	J24189019		1-	B	c1
R 2011	CHIP RES.	820	1/16W	5%	RMC1/16S 821JTH	J24189024		1-	A	B2
R 2012	CHIP RES.	180	1/16W	5%	RMC1/16S 181JTH	J24189016		1-	A	B2
R 2013	CHIP RES.	330	1/16W	5%	RMC1/16S 331JTH	J24189019		1-	A	C1
R 2014	CHIP RES.	330	1/16W	5%	RMC1/16S 331JTH	J24189019		1-	A	C2
	HOLDER				(LG)	RA0787500		1-		
	HOLDER				(LG)	RA078750A		5-		
	LIGHT GUIDE				(8ch)	RA0787600		1-		

FRONT-A Unit (VX-2100)

Note

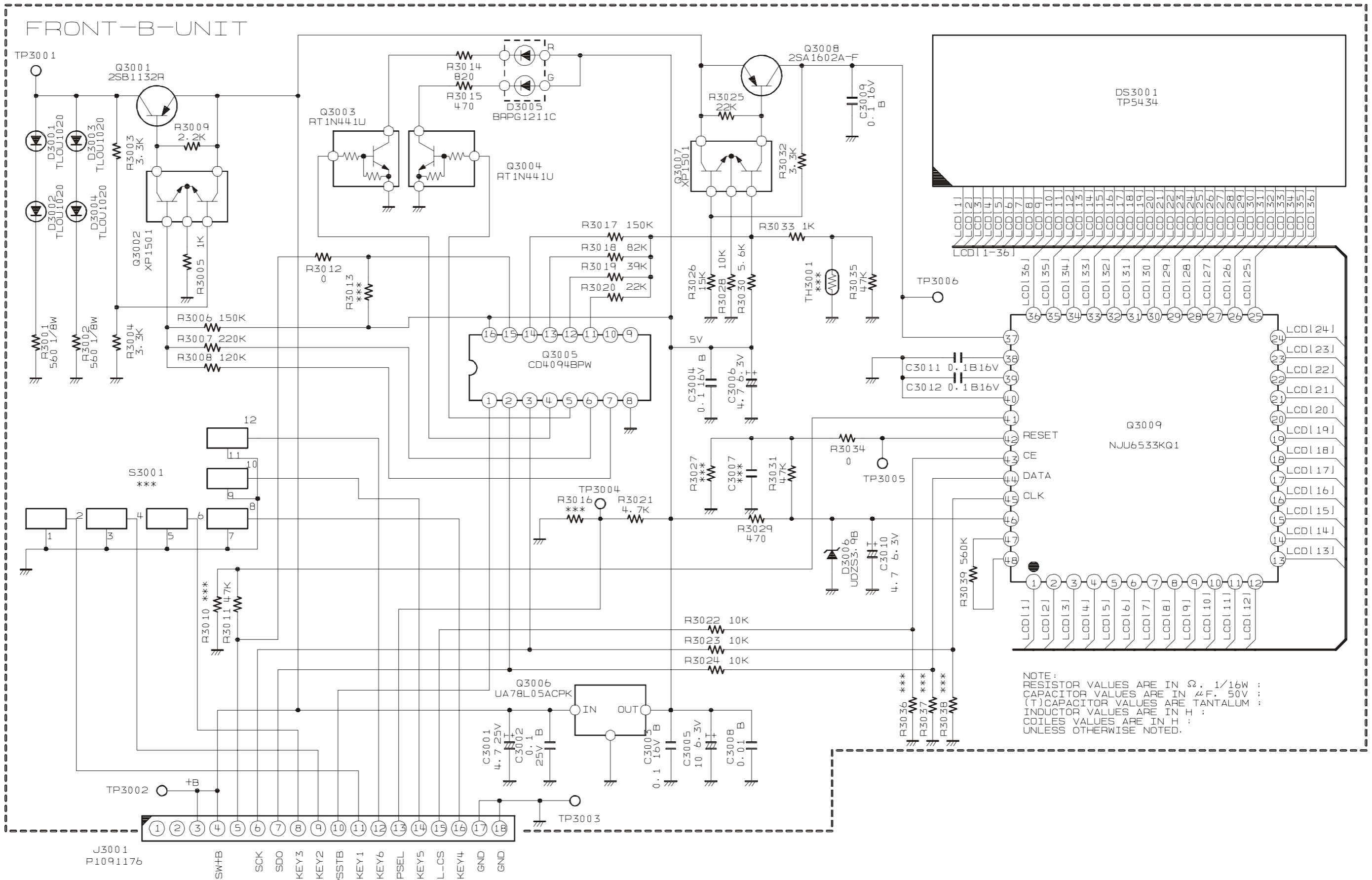

NOTE:
 RESISTOR VALUES ARE IN Ω. 1/16W ;
 CAPACITOR VALUES ARE IN μF. 50V ;
 (T)CAPACITOR VALUES ARE TANTALUM ;
 INDUCTOR VALUES ARE IN H ;
 COILES VALUES ARE IN H ;
 UNLESS OTHERWISE NOTED.

FRONT-B Unit (VX-2200)

Parts List

REF	DESCRIPTION	VALUE	V/W	TOL.	MFR'S DESIG	VXSTD P/N	VERS.	LOT	SIDE	LAY ADR
PCB with Components						CB3473001				
Printed Circuit Board						FR014520C		1-		
C 3001	CHIP TA.CAP.	4.7uF	25V		TEMSVB21E475M-8R	K78140019		1-	B	e1
C 3002	CHIP CAP.	0.1uF	25V	B	GRM40B104M25PT	K22140811		1-	B	d1
C 3003	CHIP CAP.	0.1uF	16V	B	GRM188B11C104KA01D	K22124805		1-	B	d1
C 3004	CHIP CAP.	0.1uF	16V	B	GRM188B11C104KA01D	K22124805		1-	B	c2
C 3005	CHIP TA.CAP.	10uF	6.3V		TEMSVA0J106M-8R	K78080027		1-	B	d1
C 3006	CHIP TA.CAP.	4.7uF	6.3V		TEMSVA0J475M-8R	K78080017		1-	B	c2
C 3008	CHIP CAP.	0.01uF	50V	B	GRM188B11H103KA01D	K22174823		1-	B	d1
C 3009	CHIP CAP.	0.1uF	16V	B	GRM188B11C104KA01D	K22124805		1-	B	b2
C 3010	CHIP TA.CAP.	4.7uF	6.3V		TEMSVA0J475M-8R	K78080017		1-	B	b2
C 3011	CHIP CAP.	0.1uF	16V	B	GRM188B11C104KA01D	K22124805		1-	B	b3
C 3012	CHIP CAP.	0.1uF	16V	B	GRM188B11C104KA01D	K22124805		1-	B	b3
D 3001	LED				TLOU1020(T14.F)	G2070990		1-	A	B1
D 3002	LED				TLOU1020(T14.F)	G2070990		1-	A	B1
D 3003	LED				TLOU1020(T14.F)	G2070990		1-	A	C1
D 3004	LED				TLOU1020(T14.F)	G2070990		1-	A	D1
D 3005	LED				BRPG1211C-TR	G2070654		1-	A	A1
D 3006	DIODE				UDZS TE-17 3.9B	G2070906		1-	B	e2
DS3001	LCD				TP5434 (AC061)	G6090173		1-	A	C2
J 3001	CONNECTOR				18FLT-SM1-TB	P1091176		1-	B	e1
Q 3001	TRANSISTOR				2SB1132 T100 R	G3211327R		1-	B	e2
Q 3002	TRANSISTOR				XP1501-(TX)	G3070143		1-	B	f1
Q 3003	TRANSISTOR				RT1N441U-T11-1	G3070247		1-	B	c1
Q 3004	TRANSISTOR				RT1N441U-T11-1	G3070247		1-	B	c1
Q 3005	IC				CD4094BPWR	G1093866		1-	B	c1
Q 3006	IC				UA78L05ACPK	G1094156		1-	B	d1
Q 3007	TRANSISTOR				XP1501-(TX)	G3070143		1-	B	c2
Q 3008	TRANSISTOR				2SA1602A-T11-1F	G3116028F		1-	B	c2
Q 3009	IC				NJU6533KQ1	G1094259		1-	B	d3
R 3001	CHIP RES.	560	1/8W	5%	RMC1/8T 561J	J24215561		1-	B	f1
R 3002	CHIP RES.	560	1/8W	5%	RMC1/8T 561J	J24215561		1-	B	c1
R 3003	CHIP RES.	3.3k	1/16W	5%	RMC1/16 332JATP	J24185332		1-	B	f1
R 3004	CHIP RES.	3.3k	1/16W	5%	RMC1/16 332JATP	J24185332		1-	B	f1
R 3005	CHIP RES.	1k	1/16W	5%	RMC1/16 102JATP	J24185102		1-	B	f1
R 3006	CHIP RES.	150k	1/16W	5%	RMC1/16 154JATP	J24185154		1-	B	d1
R 3007	CHIP RES.	220k	1/16W	5%	RMC1/16 224JATP	J24185224		1-	B	d1
R 3008	CHIP RES.	120k	1/16W	5%	RMC1/16 124JATP	J24185124		1-	B	d1
R 3009	CHIP RES.	2.2k	1/16W	5%	RMC1/16 222JATP	J24185222		1-	B	e2
R 3011	CHIP RES.	47k	1/16W	5%	RMC1/16 473JATP	J24185473		1-	B	e3
R 3012	CHIP RES.	0	1/16W	5%	RMC1/16 000JATP	J24185000		1-	B	f1
R 3014	CHIP RES.	820	1/16W	5%	RMC1/16 821JATP	J24185821		1-	B	c1
R 3015	CHIP RES.	470	1/16W	5%	RMC1/16 471JATP	J24185471		1-	B	c1
R 3017	CHIP RES.	150k	1/16W	5%	RMC1/16 154JATP	J24185154		1-	B	c2
R 3018	CHIP RES.	82k	1/16W	5%	RMC1/16 823JATP	J24185823		1-	B	c1
R 3019	CHIP RES.	39k	1/16W	5%	RMC1/16 393JATP	J24185393		1-	B	c1
R 3020	CHIP RES.	22k	1/16W	5%	RMC1/16 223JATP	J24185223		1-	B	c1
R 3021	CHIP RES.	4.7k	1/16W	5%	RMC1/16 472JATP	J24185472		1-	B	d2
R 3022	CHIP RES.	10k	1/16W	5%	RMC1/16 103JATP	J24185103		1-	B	f1
R 3023	CHIP RES.	10k	1/16W	5%	RMC1/16 103JATP	J24185103		1-	B	e2
R 3024	CHIP RES.	10k	1/16W	5%	RMC1/16 103JATP	J24185103		1-	B	e2
R 3025	CHIP RES.	22k	1/16W	5%	RMC1/16 223JATP	J24185223		1-	B	c2
R 3026	CHIP RES.	15k	1/16W	5%	RMC1/16 153JATP	J24185153		1-	B	b1
R 3028	CHIP RES.	10k	1/16W	5%	RMC1/16 103JATP	J24185103		1-	B	b1
R 3029	CHIP RES.	470	1/16W	5%	RMC1/16 471JATP	J24185471		1-	B	d2
R 3030	CHIP RES.	5.6k	1/16W	5%	RMC1/16 562JATP	J24185562		1-	B	c1
R 3031	CHIP RES.	47k	1/16W	5%	RMC1/16 473JATP	J24185473		1-	B	b2
R 3032	CHIP RES.	3.3k	1/16W	5%	RMC1/16 332JATP	J24185332		1-	B	b2
R 3033	CHIP RES.	1k	1/16W	5%	RMC1/16 102JATP	J24185102		1-	B	b1
R 3034	CHIP RES.	0	1/16W	5%	RMC1/16 000JATP	J24185000		1-	B	b3
R 3035	CHIP RES.	47k	1/16W	5%	RMC1/16 473JATP	J24185473		1-	B	b1
R 3039	CHIP RES.	560k	1/16W	5%	RMC1/16S 564JTH	J24189058		1-	B	d3
	LCD HOLDER				(LCD)	RA0786300		1-		
	SPONGE RUBBER				(LCD)	RA0786900		1-		
	LIGHT GUIDE					RA078640A		1-		
	REFLECTOR SHEET					RA0790900		1-		
	INTERCONNECTOR					RA0786200		1-		

FRONT-B Unit (VX-2200)

Note:

FVP-25 Encryption/DTMF Pager Unit (Option)

Circuit Diagram

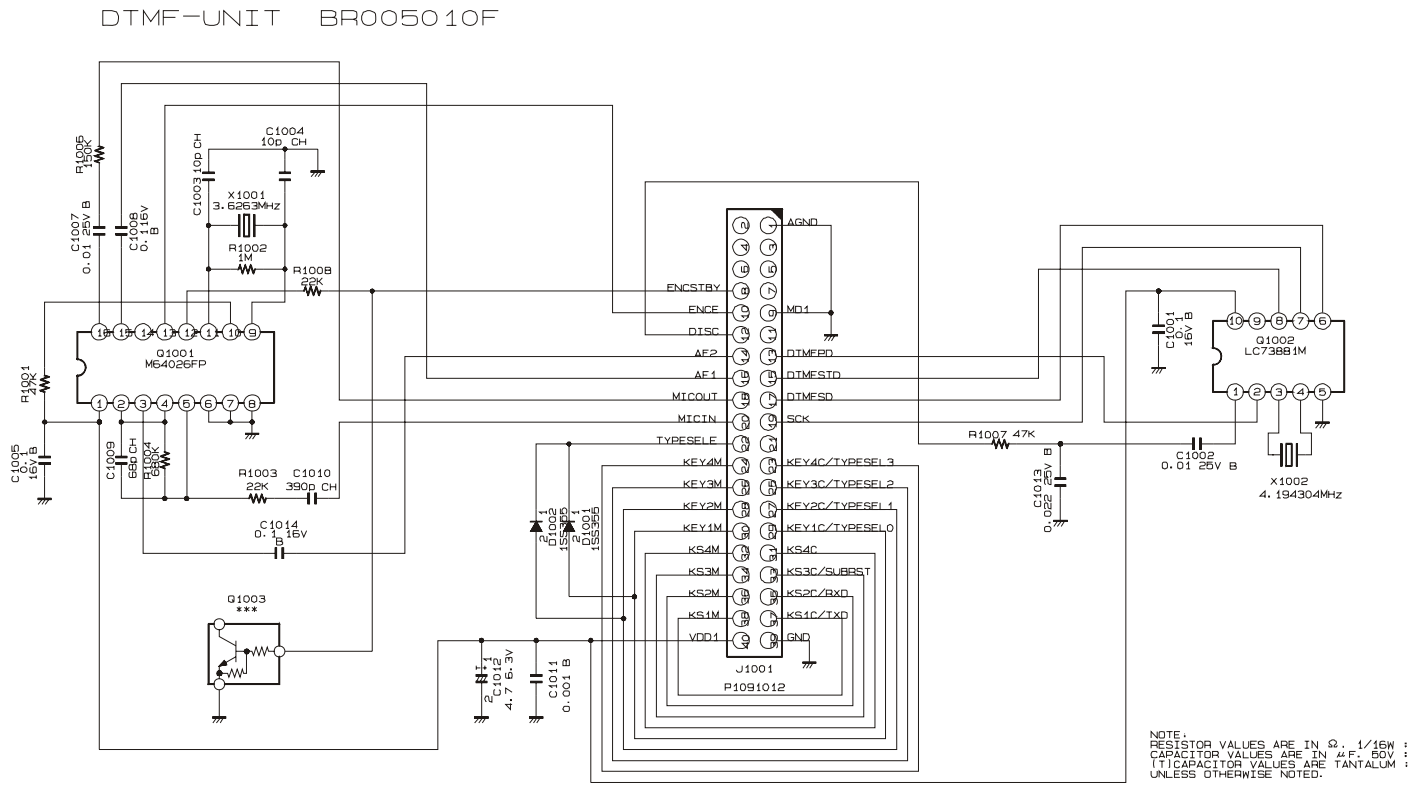

Parts Layout

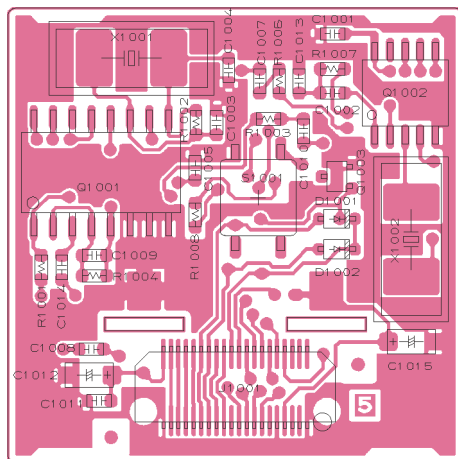

Side A

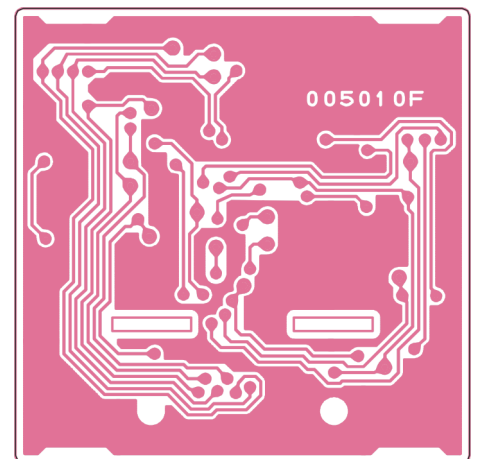

Side B

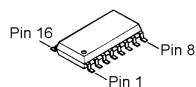

M64026FP
(Q1001)

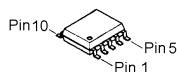

LC73881
(Q1002)

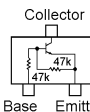

DTC144EU (26)
(Q1003)

FVP-25 Encryption/DTMF Pager Unit (Option)

Parts List

REF	DESCRIPTION	VALUE	V/W	TOL.	MFR'S DESIG	VXSTD P/N	VERS.	LOT	SIDE	LAY ADR
Printed Circuit Board						FR005010F				
C 1001	CHIP CAP.	0.1uF	16V	B	GRM188B11C104KA01D	K22124805		1-		
C 1002	CHIP CAP.	0.01uF	25V	B	GRM39B103M25PT	K22144802		1-		
C 1003	CHIP CAP.	10pF	50V	CH	GRM1882C1H100JA01D	K22174211		1-		
C 1004	CHIP CAP.	10pF	50V	CH	GRM1882C1H100JA01D	K22174211		1-		
C 1005	CHIP CAP.	0.1uF	16V	B	GRM188B11C104KA01D	K22124805		1-		
C 1007	CHIP CAP.	0.1uF	16V	B	GRM188B11C104KA01D	K22124805		1-		
C 1007	CHIP CAP.	0.01uF	25V	B	GRM39B103M25PT	K22144802		32-		
C 1008	CHIP CAP.	0.1uF	16V	B	GRM188B11C104KA01D	K22124805		1-		
C 1009	CHIP CAP.	68pF	50V	CH	GRM1882C1H680JA01D	K22174231		1-		
C 1010	CHIP CAP.	390pF	50V	CH	GRM1882C1H391JA01D	K22174255		1-		
C 1011	CHIP CAP.	0.001uF	50V	B	GRM188B11H102KA01D	K22174821		1-		
C 1012	CHIP TA.CAP.	4.7uF	6.3V		TEMSVA0J475M-8R	K78080017		1-		
C 1013	CHIP CAP.	0.022uF	25V	B	GRM39B223K25PT	K22144807		1-		
C 1014	CHIP CAP.	0.1uF	16V	B	GRM188B11C104KA01D	K22124805		1-		
D 1001	DIODE				1SS355 TE-17	G2070470		1-		
D 1002	DIODE				1SS355 TE-17	G2070470		1-		
J 1001	CONNECTOR				AXK5S40035P	P1091012		1-		
Q 1001	IC				M64026FP-650C	G1092754		1-		
Q 1002	IC				LC73881M-TLM	G1092755		1-		
Q 1003	TRANSISTOR				DTC144EUA T106	G3070041		1-13		
R 1001	CHIP RES.	47k	1/16W	5%	RMC1/16 473JATP	J24185473		1-		
R 1002	CHIP RES.	1M	1/16W	5%	RMC1/16 105JATP	J24185105		1-		
R 1003	CHIP RES.	22k	1/16W	5%	RMC1/16 223JATP	J24185223		1-		
R 1004	CHIP RES.	680k	1/16W	5%	RMC1/16 684JATP	J24185684		1-		
R 1006	CHIP RES.	150k	1/16W	5%	RMC1/16 154JATP	J24185154		1-		
R 1007	CHIP RES.	47k	1/16W	5%	RMC1/16 473JATP	J24185473		1-		
R 1008	CHIP RES.	10k	1/16W	5%	RMC1/16 103JATP	J24185103		1-		
R 1008	CARBON FILM RES.	22k	1/8W	5%	RD18TJ223 22K	J01215223		14-		
R 1008	CHIP RES.	22k	1/16W	5%	RMC1/16 223JATP	J24185223		17-		
R 1009	CHIP RES.	3.3M	1/16W	5%	RMC1/16 335JATP	J24185335		68-		
X 1001	XTAL SX-1315	3.6263MHz			3.6263MHZ	H0103183		1-		
X 1002	XTAL SX-1315	4.194304MHz			4.194304MHZ	H0103184		1-		

FVP-36 Voice Inversion Type Encryption Unit (Option)

Circuit Diagram

DTMF-UNIT BR005010F

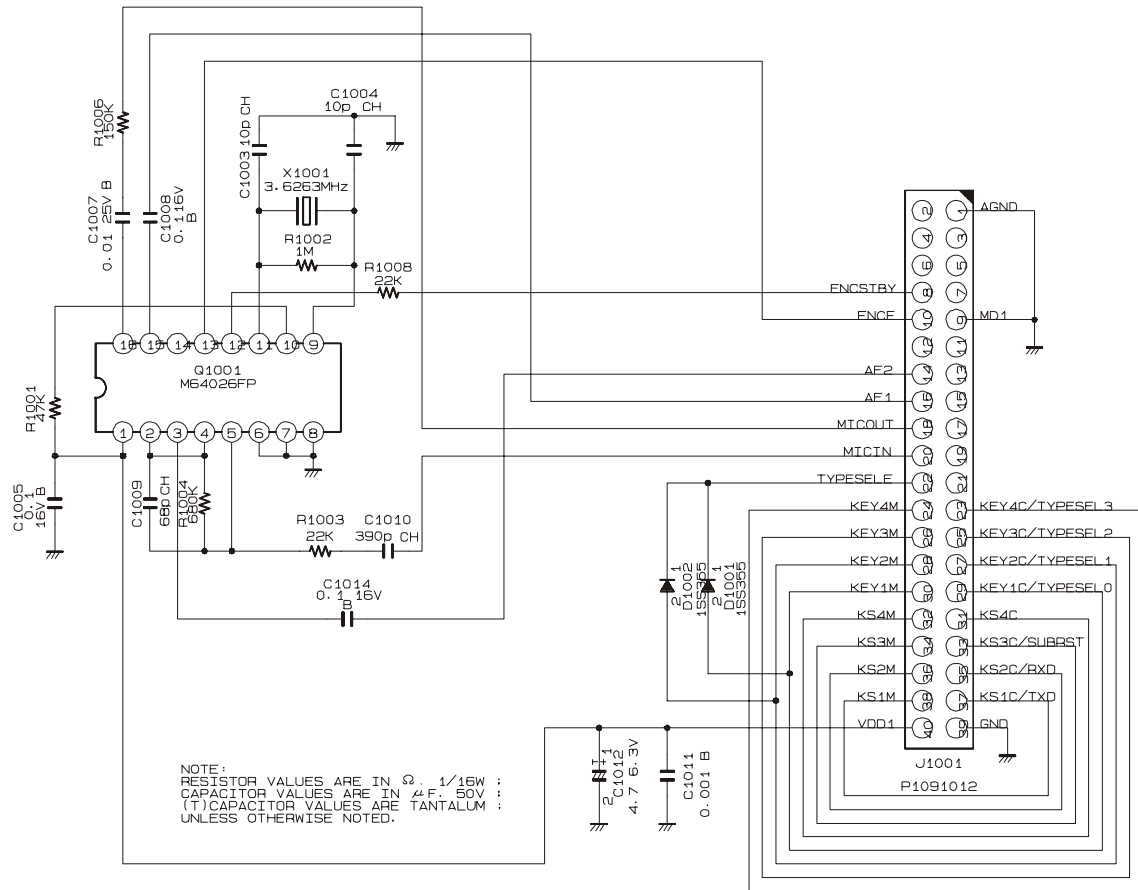

Parts Layout

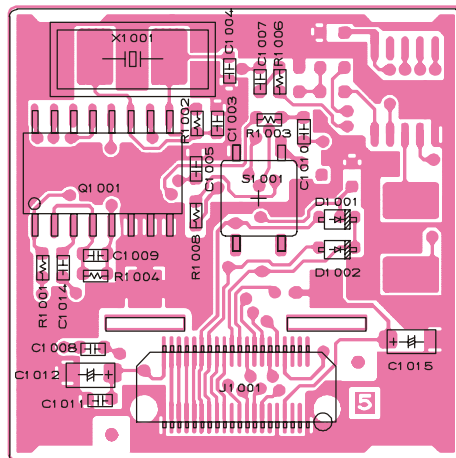
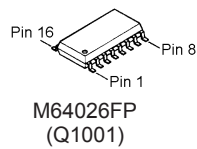

Side A

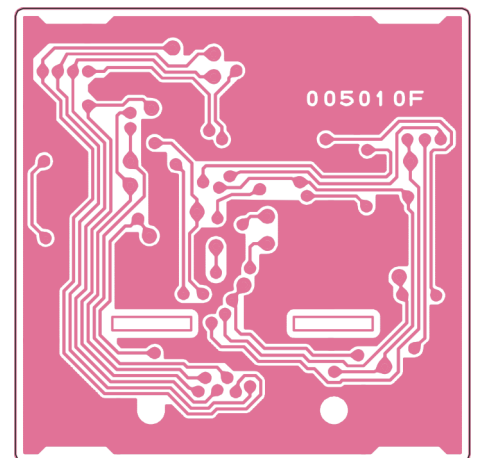

Side B

FVP-36 Voice Inversion Type Encryption Unit (Option)

Parts List

REF	DESCRIPTION	VALUE	V/W	TOL.	MFR'S DESIG	VXSTD P/N	VERS.	LOT	SIDE	LAY ADR
Printed Circuit Board						FR005010F				
C 1003	CHIP CAP.	10pF	50V	CH	GRM1882C1H100JA01D	K22174211		1-		
C 1004	CHIP CAP.	10pF	50V	CH	GRM1882C1H100JA01D	K22174211		1-		
C 1005	CHIP CAP.	0.1uF	16V	B	GRM188B11C104KA01D	K22124805		1-		
C 1007	CHIP CAP.	0.01uF	25V	B	GRM39B103M25PT	K22144802		1-		
C 1008	CHIP CAP.	0.1uF	16V	B	GRM188B11C104KA01D	K22124805		1-		
C 1009	CHIP CAP.	68pF	50V	CH	GRM1882C1H680JA01D	K22174231		1-		
C 1010	CHIP CAP.	390pF	50V	CH	GRM1882C1H391JA01D	K22174255		1-		
C 1011	CHIP CAP.	0.001uF	50V	B	GRM188B11H102KA01D	K22174821		1-		
C 1012	CHIP TA.CAP.	4.7uF	6.3V		TEMSVA0J475M-8R	K78080017		1-		
C 1014	CHIP CAP.	0.1uF	16V	B	GRM188B11C104KA01D	K22124805		1-		
D 1001	DIODE				1SS355 TE-17	G2070470		1-		
D 1002	DIODE				1SS355 TE-17	G2070470		1-		
J 1001	CONNECTOR				AXK5S40035P	P1091012		1-		
Q 1001	IC				M64026FP-650C	G1092754		1-		
R 1001	CHIP RES.	47k	1/16W	5%	RMC1/16 473JATP	J24185473		1-		
R 1002	CHIP RES.	1M	1/16W	5%	RMC1/16 105JATP	J24185105		1-		
R 1003	CHIP RES.	22k	1/16W	5%	RMC1/16 223JATP	J24185223		1-		
R 1004	CHIP RES.	680k	1/16W	5%	RMC1/16 684JATP	J24185684		1-		
R 1006	CHIP RES.	150k	1/16W	5%	RMC1/16 154JATP	J24185154		1-		
R 1008	CHIP RES.	10k	1/16W	5%	RMC1/16 103JATP	J24185103		1-		
R 1008	CARBON FILM RES.	22k	1/8W	5%	RD18TJ223 22K	J01215223		1-		
R 1008	CHIP RES.	22k	1/16W	5%	RMC1/16 223JATP	J24185223		1-		
R 1009	CHIP RES.	3.3M	1/16W	5%	RMC1/16 335JATP	J24185335		1-		
X 1001	XTAL SX-1315	3.6263MHz			3.6263MHZ	H0103183		1-		



Copyright 2006
VERTEX STANDARD CO., LTD.
All rights reserved

No portion of this manual
may be reproduced without
the permission of
VERTEX STANDARD CO., LTD.