

vertex®

VX-3000V

Service Manual

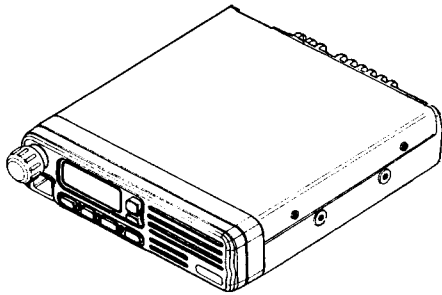

48 and 120 channel versions

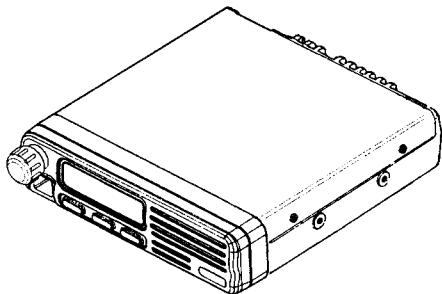

4 channel version

VERTEX STANDARD CO., LTD.

4-8-8 Nakameguro, Meguro-Ku, Tokyo 153-8644, Japan

VERTEX STANDARD

US Headquarters

10900 Walker Street, Cypress, CA 90630, U.S.A.

International Division

8350 N.W. 52nd Terrace, Suite 201, Miami, FL 33166, U.S.A.

YAESU EUROPE B.V.

P.O. Box 75525, 1118 ZN Schiphol, The Netherlands

YAESU UK LTD.

Unit 12, Sun Valley Business Park, Winnall Close
Winchester, Hampshire, SO23 0LB, U.K.

VERTEX STANDARD HK LTD.

Unit 5, 20/F., Seaview Centre, 139-141 Hoi Bun Road,
Kwun Tong, Kowloon, Hong Kong

Contents

Introduction	1-1
Specifications	1-2
Chip Component Information	1-3
Operation Manual Reprint	1-6
Exploded View & Miscellaneous Parts	2-1
Alignment	2-3
Component Application.....	2-7
Circuit Description	3-1
Block Diagram	3-5
Interconnection Diagram	3-8
RF Unit	4A-1
<i>Circuit Diagram</i>	<i>1</i>
<i>Parts Layout</i>	<i>3</i>
<i>Parts List</i>	<i>5</i>
DSUB Unit	4B-1
<i>Circuit Diagram</i>	<i>1</i>
<i>Parts Layout</i>	<i>1</i>
<i>Parts List</i>	<i>1</i>
FRONT-A Unit	4C-1
<i>Circuit Diagram</i>	<i>1</i>
<i>Parts Layout</i>	<i>3</i>
<i>Parts List</i>	<i>5</i>
FRONT-B Unit	4D-1
<i>Circuit Diagram</i>	<i>1</i>
<i>Parts Layout</i>	<i>3</i>
<i>Parts List</i>	<i>5</i>
VR Unit	4E-1
<i>Circuit Diagram</i>	<i>1</i>
<i>Parts Layout</i>	<i>1</i>
<i>Parts List</i>	<i>1</i>
MIC Unit	4F-1
<i>Circuit Diagram</i>	<i>1</i>
<i>Parts Layout</i>	<i>1</i>
<i>Parts List</i>	<i>1</i>

Cut out the label at the right, and place it behind the clear plastic window in the spine of the manual.



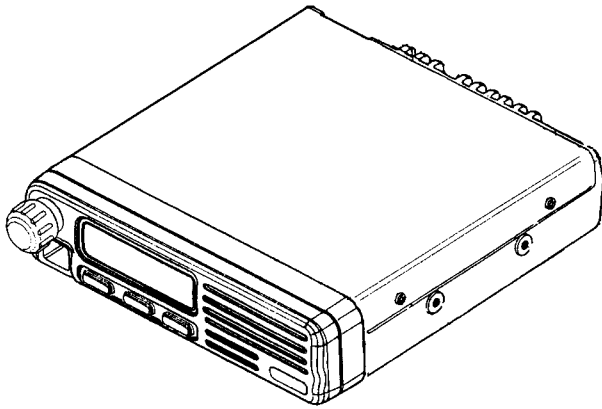

4 channel version

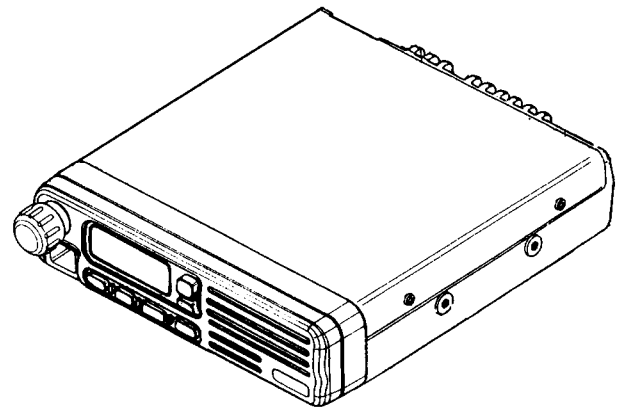

48 and 120 channel versions

This manual provides technical information necessary for servicing the VX-3000V VHF Land Mobile transceiver. It does not include information on installation and operation, which are described in the VX-3000V Operating Manual, provided with each transceiver, or on VX-3000V accessories, which are described in manuals provided with each.

The VX-3000V is carefully designed to allow the knowledgeable operator to make nearly all adjustments required for various station conditions, modes and operator preferences simply from the controls on the panels, without opening the case of the transceiver. The VX-3000V Operating Manual describes these adjustments, plus certain internal settings.

Servicing this equipment requires expertise in handling surface mount chip components. Attempts by non-qualified persons to service this equipment may result in permanent damage not

covered by warranty.

For the major circuit boards, each side of the board is identified by the type of the majority of components installed on that side.

In most cases one side has only chip components, and the other has either a mixture of both chip and lead components (trimmers, coils, electrolytic capacitors, packaged ICs, etc.), or lead components only.

While we believe the technical information in this manual is correct, Vertex Standard assumes no liability for damage that may occur as a result of typographical or other errors that may be present. Your cooperation in pointing out any inconsistencies in the technical information would be appreciated. Vertex Standard reserves the right to make changes in this transceiver and the alignment procedures, in the interest of technological improvement, without notification of the owners.

Specifications

General

Frequency Range (version):	134 ~150 or 146 ~ 174 MHz (VHF high-band vers. A/C, respectively)
No. of Channels & Spacing:	4, 48 or 120 channels 30-kHz, 25-kHz spacing and 12.5-kHz spacing
Modes of Emission:	16K0F3E ,11K0F3E (direct frequency modulation)
Frequency Stability:	±0.00025%
Antenna Requirements:	50 ohms, unbalanced (SO-239 socket)
Voltage Requirements:	11.8 to 15.6 V DC, negative ground
Current Consumption (approx.):	400 mA Stby, 1.4A Rx, 13 A Tx
Operating Temperature Range:	-30 to +60 °C (-22 to +140 °F)
Size (WHD, approx.):	160 x 40 x 160 mm (6-1/4 x 1-1/2 x 6-1/4 inch)
Weight (approx.):	1.4 kg (3.1 lbs.)

Receiver

Receiver Circuit Type:	Double Conversion Superheterodyne
Intermediate Frequencies:	21.4 MHz , and 455 kHz (all models)
Sensitivity:	0.25/0.3 μV for 12-dB SINAD 0.35/0.45 μV for 20 dB NQ
Hum & Noise Ratio:	Better than 46 dB for 25-kHz/step, Better than 38 dB for 12.5-kHz/step
Adjacent Channel Selectivity:	>70 dB for 25-kHz/step, >60 dB for 12.5-kHz/step
Intermodulation Distortion:	Better than 70 dB
Spurious Rejection:	Better than 70 dB
External Audio Output Power:	10 watts into 4 ohms with <10% THD

Transmitter

Power Output:	50/5 watts (high/low, programmable)
Modulation Type/Deviation:	Frequency Modulation, ±5 kHz (±2.5 kHz)
Hum & Noise Ratio:	Better than 46 dB for 25-kHz/step, Better than 38 dB for 12.5-kHz/step
Modulation Distortion:	Less than 5%
Spurious Emissions:	Better than 70 dB (below carrier)
Microphone Impedance:	600 Ohms

Specifications are subject to change without notice or obligation.

Chip Component Information

The diagrams below indicate some of the distinguishing features of common chip components .

Capacitors

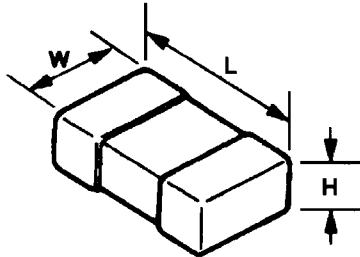

(Unit: mm)

Type	L	W	H
2125	2.0	1.25	0.35 ~ 0.5
1608	1.6	0.8	0.65 ~ 0.95
1005	1.0	0.5	0.45 ~ 0.55

Tantalum Capacitors

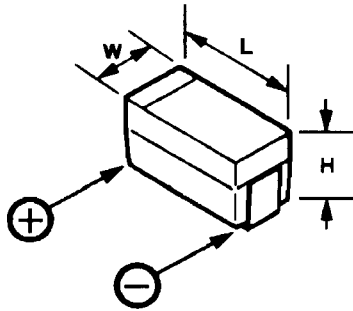

(Unit: mm)

Type	L	W	H
P	2.0	1.25	1.2
A	3.2	1.6	1.6
B	3.4	2.8	1.9
C	5.8	3.2	2.3

Resistors

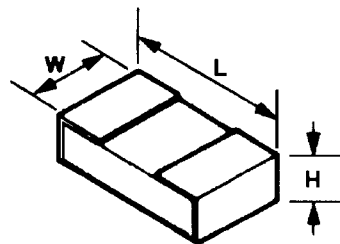

Marking* 100, 222, 473...

473

Ten unit	One unit	Multiplier code
0	0	10 ⁰
1	1	10 ¹
2	2	10 ²
3	3	10 ³
4	4	10 ⁴
5	5	10 ⁵
6	6	10 ⁶
7	7	10 ⁷
8	8	10 ⁸
9	9	10 ⁹

Indicated Letters

1 2 3 4 5 6 7 8 9 0 .

(Unit: mm)

Type	L	W	H
1/10	2.0	1.25	0.5
1/16	1.6	0.8	0.45
1/16S	1.0	0.5	0.35

Examples: 100=10Ω
222=2.2kΩ
473=47kΩ

Chip Component Information

Replacing Chip Components

Chip components are installed at the factory by a series of robots. The first one places a small spot of adhesive resin at the location where each part is to be installed, and later robots handle and place parts using vacuum suction.

For single sided boards, solder paste is applied and the board is then baked to harden the resin and flow the solder. For double sided boards, no solder paste is applied, but the board is baked (or exposed to ultra-violet light) to cure the resin before dip soldering.

In our laboratories and service shops, small quantities of chip components are mounted manually by applying a spot of resin, placing with tweezers, and then soldering by very small dual streams of hot air (without physical contact during soldering). We remove parts by first removing solder using a vacuum suction iron, which applies a light steady vacuum at the iron tip, and then breaking the adhesive with tweezers.

The special vacuum/desoldering equipment is recommended if you expect to do a lot of chip replacements. Otherwise, it is usually possible to remove and replace chip components with only a tapered, temperature-controlled soldering iron, a set of tweezers and braided copper solder wick. Soldering iron temperature should be below 280°C (536°F).

Precautions for Chip Replacement

- Do not disconnect a chip forcefully, or the foil pattern may peel off the board.
- Never re-use a chip component. Dispose of all removed chip components immediately to avoid mixing with new parts.
- Limit soldering time to 3 seconds or less to avoid damaging the component and board.

Removing Chip Components

- Remove the solder at each joint, one joint at a time, using solder wick whetted with non-acidic fluxes as shown below. Avoid applying pressure, and do not attempt to remove tinning from the chip's electrode.

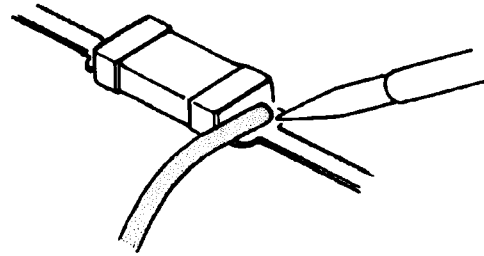

- Grasp the chip on both sides with tweezers, and gently twist the tweezers back and forth (to break the adhesive bond) while alternately heating each electrode. Be careful to avoid peeling the foil traces from the board. Dispose of the chip when removed.
- After removing the chip, use the copper braid and soldering iron to wick away any excess solder and smooth the land for installation of the replacement part.

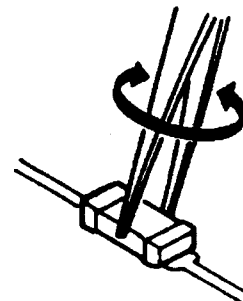

Chip Component Information

Installing a Replacement Chip

As the value of some chip components is not indicated on the body of the chip, be careful to get the right part for replacement.

- Apply a small amount of solder to the land on one side where the chip is to be installed. Avoid too much solder, which may cause bridging (shorting to other parts).

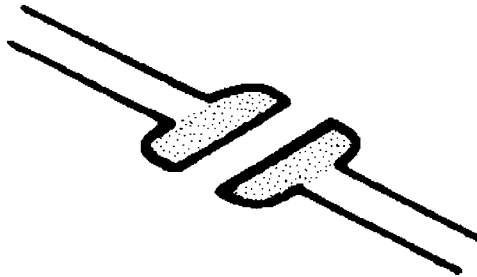

- Hold the chip with tweezers in the desired position, and apply the soldering iron with a motion line as indicated by the arrow in the diagram below. Do not apply heat for more than 3 seconds.

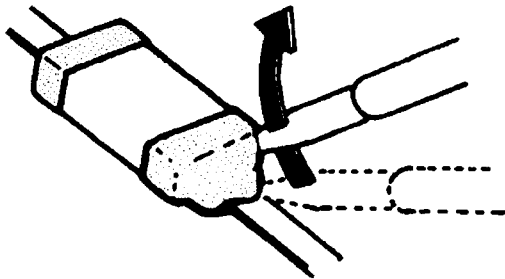

- Remove the tweezers and solder the electrode on the other side in the manner just described.

Controls & Connectors

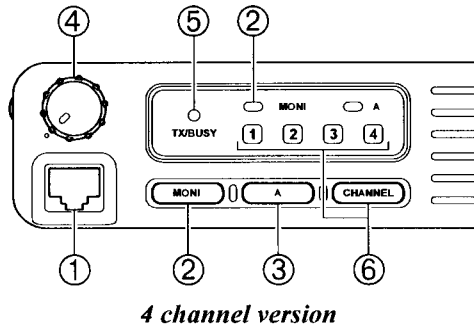

4 channel version

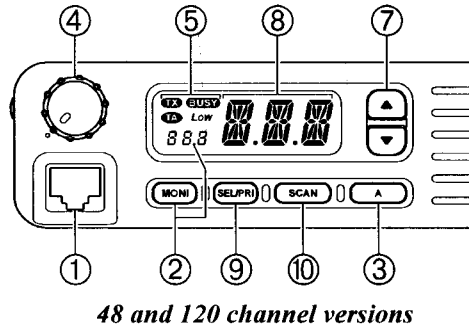

48 and 120 channel versions

① Microphone Jack

Press the microphone plug firmly into this jack until it locks. To remove the microphone, press the lever protruding from the bottom side of the plug while pulling it out.

② MONI Button & Indicator

This button selects the squelch (receiver muting) mode. When the indicator is off, tone (or coded) squelch is active. When you press **MONI** momentarily, the “**MONI**” indicator blinks (4 channel version) or a small Dot [●] will be displayed (48/120 channel versions); in this condition, only the “noise” squelch is active, and any station which transmits on the channel will be heard. Pressing **MONI** and holding it in for more than 1.5 second, on the other hand, will open the squelch completely, and background noise will be heard if no signal is present (both the small Dot and the “**BUSY**” indicator will appear on the 48/120 channel versions, while “**MONI**” will glow steadily on the 4-channel version).

If you hear constant background noise, with no signals present (“**MONI**” glows steadily or “**BUSY**” and the small Dot are both present), press the **MONI** button once to return to the previous (quiet) tone-squelched mode.

③ A (Accessory) Button

In VHF Low-band versions, this button can be set by your dealer to activate the noise blanker. Otherwise, this button (and the orange indicator above it) can be set up for special applications, such as high/low power selection, talk-around, and call alert functions, as determined by your network requirements and programmed by your Yaesu dealer.

④ VOLUME and POWER On/Off Knob

Turn this control clockwise to turn the radio on and to increase the volume. Turn it counterclockwise into the click-stop to turn the radio off.

The following items are unique to 4-channel versions:

⑤ TX/BUSY Indicator Lamp

This lamp glows green when the channel is busy, and red during transmission by your radio.

⑥ CHANNEL Numbered Indicators & Button

Press the **CHANNEL** button to select the operating channel; the channel number currently in use will light up on the display.

The remaining items are unique to 48 and 120-channel versions:

⑤ BUSY/TX Indicators

This “**BUSY**” icon appears when the channel is busy, and “**TX**” appears while transmitting.

⑦ CHANNEL Selector Buttons (▲) and (▼)

Push one of these keys to select the operating channel, as shown on the display.

⑧ Numeric Channel Display

The display includes an 3-character numeric section showing channel and group numbers plus status and identity information. Additional indicators on the display show priority channel assignments (“**Pr1**” and “**Pr2**”) and scan channel selection (“**E**” means “**E**nabled for scanning”).

⑨ SEL/PRI Button

This button allows selection of memory channel groups, and (together with the **SCAN** button) selects scanning modes (Dealer, User, Priority/Dealer, Priority/User, Group/Dealer, Group/User, Dealer DW, User DW) as described in the next chapter, *Basic Operation of the Transceiver*.

⑩ SCAN Button

This button is used to activate (current group) channel scanning, to select and deselect channels for scanning, and (together with the **SEL/PRI** button) to select scanning modes, as described in the next section. Pressing the **SCAN** button for more than 1.5 second enables scanning of *all* channels (in all groups).

REAR (Heatsink)

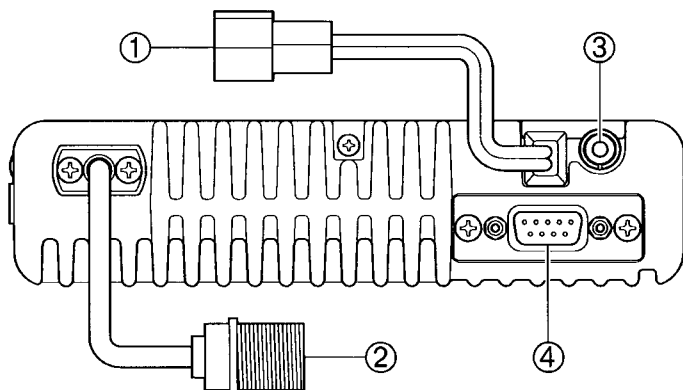

① **13.8-V DC Cable Pigtail w/Connector**

The supplied DC power cable must be connected to this 2-pin connector. Use only the supplied (fused) cable, extended if necessary, for power connection.

② **Antenna Cable with Connector**

The 50-ohm coaxial feedline to the antenna must be connected here, using a “UHF” type (PL-259) plug.

③ **External Speaker Jack**

An external loudspeaker may be connected to this 2-contact, 3.5-mm mini-phone jack.

Caution: Do not connect this line to ground, and be certain that the speaker has adequate capability to handle the audio output from the VX-3000.

④ **DSUB 9-Pin Data Connector**

External TX audio line input, **PTT** (Push To Talk), Squelch, and external RX audio line output signals may be obtained from this connector for use with accessories such as data transmission/reception modems, etc.

Basic Operation of the Transceiver

Important! - Before turning on the radio the first time, confirm that the power connections have been made correctly and that a proper antenna is connected to the antenna jack.

Turn the **VOLUME/POWER** knob clockwise to turn on the radio. The display will become illuminated (48/120 channel versions), or the channel indicator will light up (4 channel version). The radio will start up on the last channel used prior to shut-down during the previous operating session.

In 4-channel versions, press the **CHANNEL** button to change channels. In the 48/120 channel versions, the display should show either a channel number or scan mode indicator (**DSC**, **USC**, **GDS**, **GUS**, **PDS**, **PUS**, **DDW** or **UDW**). If “**ERR**” is displayed instead, the transceiver has not yet been programmed with channel frequencies; switch off the power and contact your network administrator or Yaesu dealer. If a scan mode indicator is displayed, you can press the **SCAN** button to display a channel number, and then press either the **UP** (▲) or **DOWN** (▼) button to change channels.

Setting the Volume

If no signals are heard and the “**BUSY**” indicator or “**TX/BUSY**” LED is not illuminated, press and hold the **MONI** button for 1.5 second until background noise is heard and the “**MONI**” or “**BUSY**” indicator glows. Then adjust the volume control for a comfortable level on the background noise. Press **MONI** button again momentarily so the “**MONI**” or “**BUSY**” indicator disappears.

Transmitting

To transmit, wait until the “**BUSY**” indicator is off (the channel is not in use), and press the **PTT** (Push-To-Talk) switch on the side of the microphone (the “**TX**” indicator will appear or the “**TX/BUSY**” lamp will glow red). While holding in the **PTT** switch, speak across the face of the microphone in a clear, normal voice level, and then release the **PTT** switch to receive.

Automatic Time-Out Timer

If the selected channel has been programmed for automatic time-out, you must limit the length of each transmission. While transmitting, a beep will sound five seconds before time-out. Another beep will sound just before the deadline; the “**TX**” indicator will disappear and transmission will cease soon thereafter. To resume transmitting, you must release the **PTT** and wait for the “penalty timer” to expire (if you press the **PTT** before this timer expires, the timer restarts, and you will have to wait another “penalty” period).

The remaining instructions apply to 48-channel or 120-channel versions only:

Selecting Groups and Channels

- Press the **SEL/PRI** button (repeatedly, if necessary) to select a different group of channels.
- Press the **UP** (▲) or **DOWN** (▼) button to select a different channel *within the current group*.
- When you select a group, its number appears as the first digit in the new channel number which appears on the display (in other words, channel “305” represents channel #05 in channel group #3).

Scanning Modes

There are eight scanning modes, described in the list below. Each channel can be independently enabled or disabled for scanning; only channels selected for scanning within the enabled group are scanned. Also, as mentioned before, each group can have up to two priority channels which are scanned more often than the non-priority channels.

The **SCAN** modes and their corresponding displays are as follows:

Display	Scanning Function
DSC	Dealer Scan (only within the current group)
USC	User Scan: only user-selected channels (only within the current group)
GDS	Group Dealer Scan: scan all Dealer-selected channels in all groups
GUS	Group User Scan: scan all User-selected channels in all groups
PDS	Priority Dealer Scan: DSC plus priority channel(s)
PUS	Priority User Scan: USC plus user priority channel(s)
DDW	Dealer Dual Watch: Monitor one channel and priority channel(s)
UDW	User Dual Watch: Monitor User-selected channel and priority channel(s)

Scanning Operation

With the microphone in its hanger, press the **SCAN** button momentarily to activate scanning. Typically, “**DSC**” will initially appear on the display, indicating Dealer Channel Scan as the scanning mode. If you wish to change to one of the modes described in the list above, press the **SEL/PRI** button repeatedly until that mode appears on the display.

If you pick up the microphone while no signal is being received, operation will shift to a particular channel. Which channel that will be depends on which of the following options the dealer has programmed for off-hook channel selection:

Scan Start Channel

Lifting the microphone causes operation to revert to the group and channel last selected before scanning started or resumed.

Priority Revert

Lifting the microphone activates the Priority 1 channel in the current group. If no channel is assigned level 1 priority, operation will be on the Priority 2 channel. If no priority channels have been assigned, operation reverts to the Scan Start Channel.

Last Busy

Lifting the microphone causes operation to revert to the group and channel where activity was last detected. If no activity was detected since turning on the radio, operation reverts to the Scan Start Channel.

How to Select Channels to be Scanned

If your radio has been configured by your Dealer to allow you, the operator, to make changes to the list of channels to be scanned, you can make these changes by following this simple process:

- ① Turn the transceiver OFF by rotating the **VOLUME/POWER** control fully counter-clockwise into the click-stop.
- ② Press and hold in the **SEL/PRI** button; while holding this button in, rotate the **VOLUME/POWER** control clockwise out of the click-stop to turn the radio on. You may now release the **SEL/PRI** button.
- ③ Press the **A** button, as necessary, until the Memory Group and Memory Channel numbers will appear in *small* characters in the *left side* of the display area.
- ④ You may now push the **SEL/PRI** key momentarily as many times as necessary to choose the Memory Group within which you wish to make changes to the channel scan list. Once you have selected the desired Memory Group, you may use the **UP** (▲) or **DOWN** (▼) button to choose a particular channel within the current group.

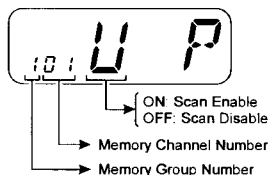

Pressing the **MONI** button will change the scanning status of the selected channel.

If you are *adding* the channel to those you wish to scan, pressing the **MONI** button causes a “U” appear on the display, indicating that the channel has been added to the User Scan List. If you are *deleting* the channel from the User Scan List (the channel’s data itself will not be deleted; the channel just will not be scanned), the “U” will disappear.

- ⑤ Repeat step 4 for each channel you wish to enable or disable for scanning.
- ⑥ When you are done making changes to the channels you wish to scan, press and hold in the **SEL/PRI** button for more than 1.5 second. Operation will return to its normal status, and the display will revert to its previous appearance.

How to Change the “User Priority” Channels

Your Dealer may have configured your radio so as to allow you to make changes to the “User Priority” Channels (the channels

you designate to be scanned more frequently than the others). The selection process is almost identical to that used for making changes to the User Scan List.

- ① Turn the transceiver OFF by rotating the **VOLUME/POWER** control fully counter-clockwise into the click-stop.
- ② Press and hold in the **SEL/PRI** button; while holding this button in, rotate the **VOLUME/POWER** control clockwise out of the click-stop to turn the radio on. You may now release the **SEL/PRI** button.
- ③ Press the **A** button, as necessary, until the Memory Group and Memory Channel numbers will appear in *large* characters in the *right side* of the display area (as compared to *small* characters in the case of changes to the Scan List).
- ④ You may now push the **SEL/PRI** button momentarily as many times as necessary to choose the Memory Group within which you wish to make changes to the User Priority Channel(s). Once you have selected the desired Memory Group, you may use the **UP** (▲) or **DOWN** (▼) button to choose a particular channel within the current group.

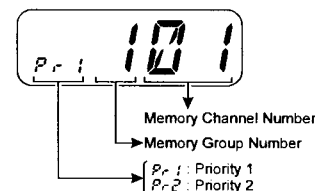

Pressing the **SCAN** button will change/assign the Priority status of the selected channel.

If you are assigning the channel to Priority status, pressing the **SCAN** button causes “Pr1” or “Pr2” to flash on the display, indicating that the channel has been assigned the status of *Priority 1* or *Priority 2*, respectively. Pressing the **SCAN** button repeatedly toggles the Priority Level between “1” and “2.” If you are *deleting* the channel from Priority status, the “Prn” indicator will disappear.

- ⑤ Repeat step 4 for each channel you wish to assign to or delete from Priority status.
- ⑥ When you are done making changes to the Priority Channels, press and hold in the **SEL/PRI** button for more than 1.5 second. Operation will return to its normal status, and the display will revert to its previous appearance.

The A Button Function

The **A** (Accessory) button can be programmed by the dealer to provide two of the other functions described below. In the case of the VHF Low-Band version of the VX-3000, pressing the **A** button can activate the Noise Blanker (a feature not available on the VHF High-Band or UHF versions).

To activate the primary Accessory function, press the **A** button momentarily. To access the secondary Accessory function (which may include the Alarm), press the **A** button and hold it in for 1.5 seconds or longer.

Call/Reset

When this feature is programmed and an selective call has been received (the “CAL” indicator is flashing), momentarily press the **A** button to reset the flashing indicator and mute the receiver, otherwise press the **A** button to send your

Operation Manual Reprint

radio's identification code (ANI) to the dispatcher.

Low Power

With this feature enabled, the **A** button toggles between high and low transmitter power, as programmed by the dealer.

Talk-Around

The feature causes the **A** button to select simplex operation on semi-duplex channels: the transmit frequency becomes the same as the receive frequency (regardless of any programmed offset for the channel).

Note: This feature has no effect on simplex channels. After pressing the button, "TA" is displayed on the LCD.

Noise Blanker

Because local noise can be particularly troublesome in the VHF Low-Band frequency spectrum, the Low-Band version of the VX-3000 includes a Noise Blanker feature, which may be toggled on and off by pressing the **A** button for the appropriate length of time.

Encryption

When the Voice Scrambler feature is enabled, pressing the **A** button toggles the Scrambler on and off.

A-On

When this function is enabled, the Noise Blanker will be activated (on the VHF Low-Band version); in other versions, this Accessory function is reserved for future optional features.

Alarm Function

When the "alarm" function is enabled, pressing and holding the **A** button for 1.5 seconds causes the radio to revert to a specially-designated channel, and causes the special "Alarm" identifier code to be transmitted automatically.

Note: this feature is only available as a "Secondary" Accessory to prevent accidental activation.

Optional Accessories

CE-19	Programming Software (for IBM PC/compatibles only)
VPL-1	Programming Cable
T9101411	Radio-to-Radio Cloning Connection Cable
FP-1025A	Heavy-Duty (20A) AC Power Supply
MD-11A8J	Desktop Microphone
MH-600D	DTMF Back-lit Microphone w/Autodial
MLS-100	External Loudspeaker
LF-1	DC Line Filter
VTM-20	VX-Trunk II Trunking Mobile Logic Board

Operation Manual Reprint

Accessory Connector

1. Abstract

The rear panel's D-SUB 9-pin connector is a versatile accessory interfacing point. This connector includes the following functions:

- TX audio, RX audio and PTT.
- Field Editor switch
- FSK DATA input/output
- HORN Alert output
- SQL output
- Ignition-controlled power switch

All these functions can be programmed by jumpers on the RF-UNIT.

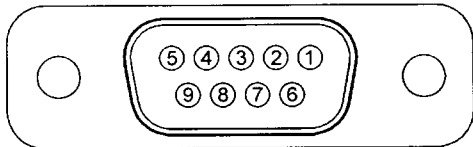

2. Pin assignments /:selectable pins

① **SQ**: Squelch output

Open collector output. Maximum sink current 50mA. Maximum voltage 13.6V (DC power supply)
Sink: A signal is present (Squelch is open)
Open: No signal is present (Squelch is closed)
When using the FSK DATA mode, this pin is controlled by FSK detector.

② **EXT_RX_AUD**: External received audio output

High impedance output (approx. 3K Ohms)
This output is enabled as a default setting at the factory.
This function is enabled by jumper JP1004 on the RF-UNIT.

/② **RXD**: Received DATA output

TTL level (+5V / 0V) output.
In the FSK mode, this line is a Received DATA output.
This function is enabled by jumpers JP1003 and JP1015 on the RF-UNIT.
When you use this output, remove the solder from jumper J1004.

③ **EXT_MIC**: External MIC input

High impedance input (approx. 10K Ohms)
Input level: 5.5mV_{rms}
This input is enabled as a default setting at the factory.
This function is enabled by jumper JP1006 on the RF-UNIT.
This feature requires activation via the Clone Editor software (check the EXTERNAL MIC flag in the group settings).

/③ **TXD**: Transmit DATA input

TTL level (+5V / 0V) input.
In the FSK mode, this line is a Transmit DATA input.
This function is enabled by jumpers JP1005 and JP1016 on the RF-UNIT.
When you use this output, remove the solder from jumper J1006.

④ **DTR**: Field editor program key input (Active Low)

When you use the Field Editor, this pin must be connected to GND.
Connect to GND: Field Editor available
Open: Field Editor not available (normal mode)
This function is enabled by jumper JP1007 on the RF-UNIT.
JP1008 is a reserved jumper.

⑤ **GND**: Signal Ground

⑥ **HO_AL**: Horn Alert output (Active Low)

Open collector output. Maximum sink current 50mA. Maximum voltage 13.6V (DC power supply).
Sink: Horn Alert on
Open: Normal

⑦ **PTT**: (Active Low)

TTL level (+5V / 0V) input. This line is internally pulled up to +5V DC.
When pulled low by an external device, it keys the transceiver's transmitter section.

⑧ **13V**

Switched DC 13.6V output for powering an external accessory.
Maximum current 250mA.
This line fuse is F1001 on the RF-UNIT.
This function is enabled by jumper JP1010 on the RF-UNIT. This feature is enabled as a default setting at the factory.

/⑧ **5V**

Switched and regulated DC 5V output for powering an external accessory.
Maximum current 50mA.
This function is enabled by jumper JP1009 on the RF-UNIT.

⑨ **IGN**: Car Ignition sense

This pin enables power switch control via the car ignition.
To use this function, remove R1187 and mount R1188 10K Ohms.
Then connect this pin to your car's (ignition-controlled) DC line.

Exploded View & Miscellaneous Parts

VXSTD P/N	Description	Qty.
Q0000075	BLADE FUSE ATC 15A	2
T9021015	DC CABLE	1

REF.	VXSTD P/N	Description	Qty.
①	U02308002	SEMS SCREW SM3X8NI	4
②	U20306002	BINDING HEAD SCREW M3X6NI	4
③	U23205001	TAPTITE SCREW M2.6X5	4
④	U23206001	TAPTITE SCREW M2.6X6	3
⑤	U24306002	TAPTITE SCREW M3X6NI	7
⑥	U31206007	OVAL HEAD SCREW M2.6X6B	7
⑦	U34206001	TAPTITE SCREW M2.6X6	4

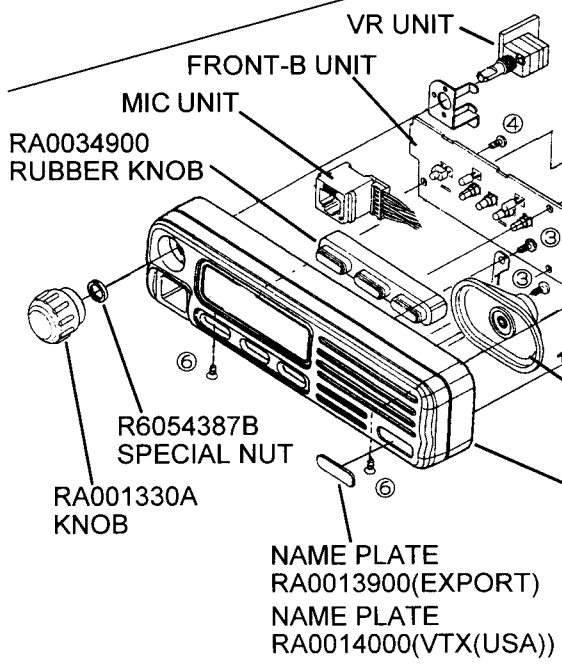
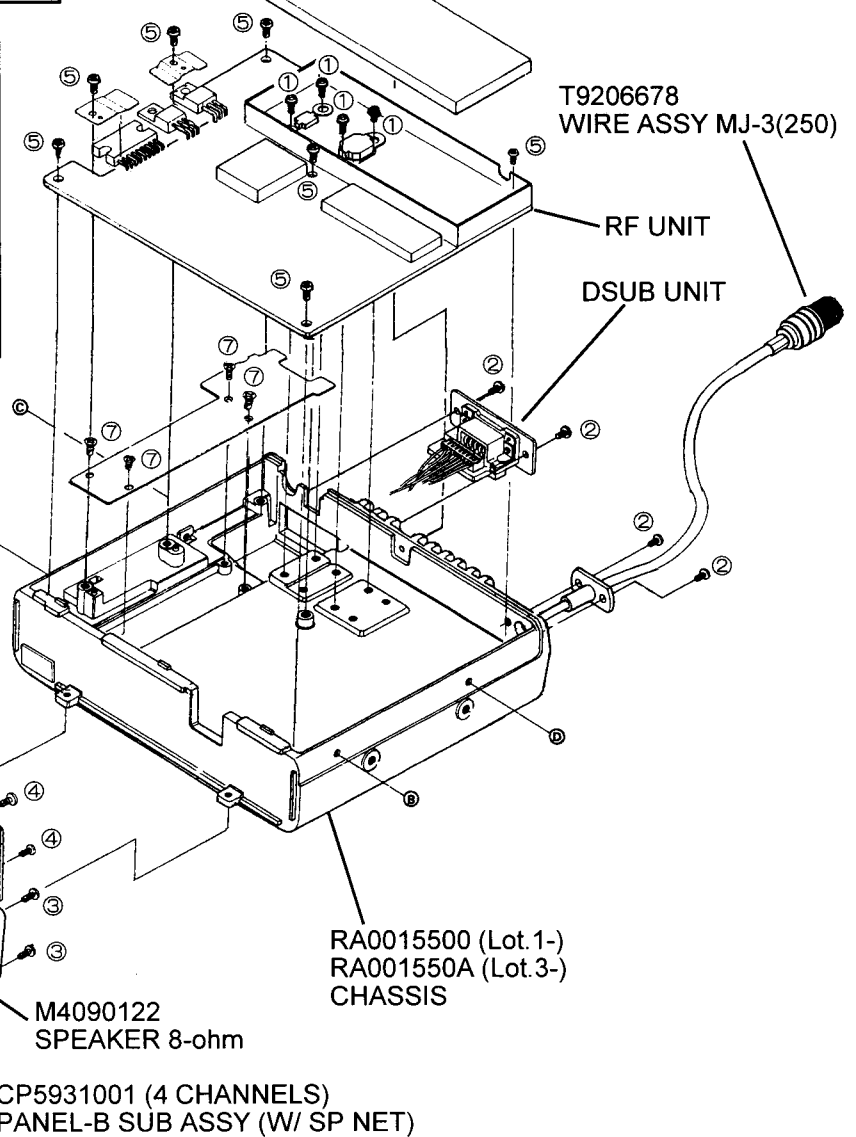
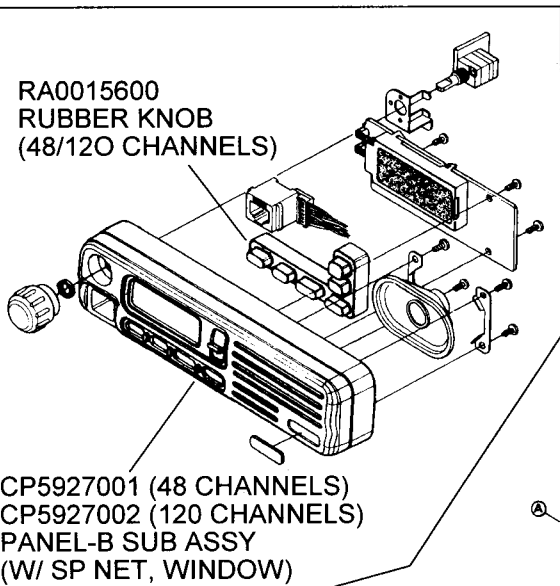
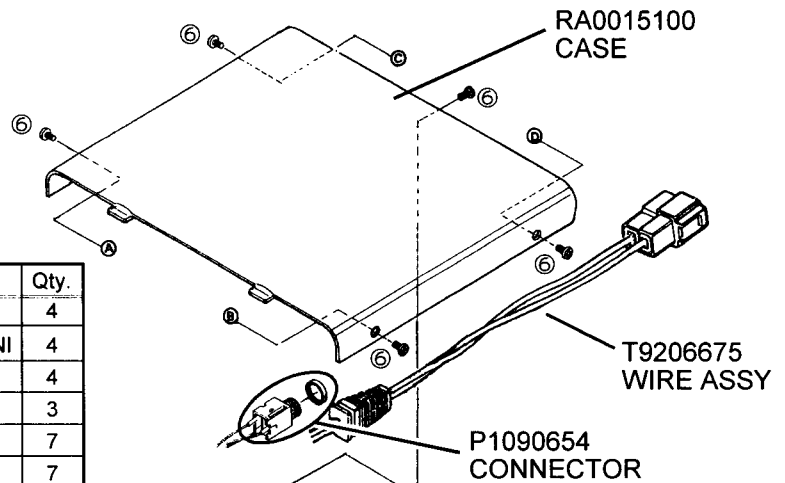

Non-designated parts are available only as part of a designated assembly.

Exploded View & Miscellaneous Parts ---

Notes:

The VX-3000V is carefully aligned at the factory for the specified performance across the frequency range specified for each version. Realignment should therefore not be necessary except in the event of a component failure, or altering version. All component replacement and service should be performed only by an authorized Vertex Standard representative, or the warranty policy may be void.

The following procedures cover the sometimes critical and tedious adjustments that are not normally required once the transceiver has left the factory. However, if damage occurs and some parts subsequently are placed, realignment may be required. If a sudden problem occurs during normal operation, it is likely due to component failure; realignment should not be done until after the faulty component has been replaced.

We recommend that servicing be performed only by authorized Vertex Standard service technicians who are experienced with the circuitry and fully equipped for repair and alignment. Therefore, if a fault is suspected, contact the dealer from whom the transceiver was purchased for instructions regarding repair. Authorized Vertex Standard service technicians realign all circuits and make complete performance checks to ensure compliance with factory specifications after replacing any faulty components.

Those who do undertake any of the following alignments are cautioned to proceed at their own risk. Problems caused by unauthorized attempts at realignment are not covered by the warranty policy. Also, Vertex Standard reserves the right to change circuits and alignment procedures in the interest of improved performance, without

notifying owners.

Under no circumstances should any alignment be attempted unless the normal function and operation of the transceiver are clearly understood, the cause of the malfunction has been clearly pinpointed and any faulty components replaced, and realignment determined to be absolutely necessary.

The following test equipment (and thorough familiarity with its correct use) is necessary for complete realignment. Correction of problems caused by misalignment resulting from use of improper test equipment is not covered under the warranty policy. While most steps do not require all of the equipment listed, the interactions of some adjustments may require that more complex adjustments be performed afterwards.

Do not attempt to perform only a single step unless it is clearly isolated electrically from all other steps. Have all test equipment ready before beginning, and follow all of the steps in a section in the order presented.

Required Test Equipment

- RF Signal Generator with calibrated output level at 200 MHz
- Deviation Meter (linear detector)
- In-line Wattmeter with 5% accuracy at 200 MHz
- 50- Ω RF Dummy Load with power rating 100 W at 200 MHz
- 4- Ω AF Dummy Load
- Regulated DC Power Supply adjustable from 3 to 15 VDC, 15 A
- Frequency Counter with 0.2 ppm accuracy at 200 MHz
- AF Signal Generator

Alignment

- AC Voltmeter
- DC Voltmeter
- VHF Sampling Coupler
- SINAD Meter
- IBM PC/compatible Computer with Microsoft Windows v3.1 or later operating system
- VPL-1 Connection Cable & Alignment Program

Alignment Preparation & Precautions

A 50- Ω RF dummy load and in-line wattmeter must be connected to the main antenna jack in all procedures that call for transmission, except where specified otherwise. Correct alignment is not possible with an antenna.

After completing one step, read the following step to determine whether the same test equipment will be required. If not, remove the test equipment (except dummy load and wattmeter, if connected) before proceeding.

Correct alignment requires that the ambient temperature be the same as that of the transceiver and test equipment, and that this temperature be held constant between 20 and 30°C (68 and 86°F). When the transceiver is brought into the shop from hot or cold air, it should be allowed time to come to room temperature before alignment.

Whenever possible, alignments should be made with oscillator shields and circuit boards firmly affixed in place. Also, the test equipment must be thoroughly warmed up before beginning.

Note: Signal levels in dB referred to in the alignment procedure are based on $0\text{dB}\mu=0.5\mu\text{V}$.

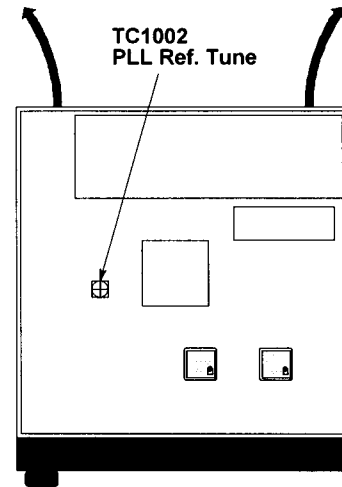

RF unit Alignment Points

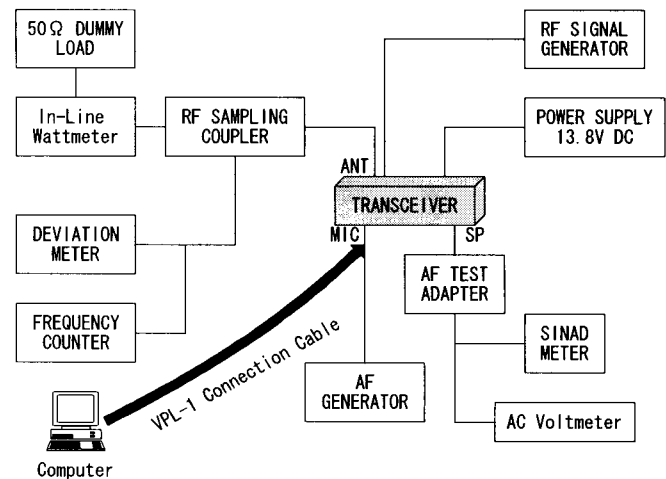

Alignment Setup

Set up the test equipment as shown for transceiver alignment, and apply 13.8V DC power to the transceiver. Refer to the drawings above for Alignment Points.

The transceiver must be programmed for use in the intended system before alignment is attempted. The RF parameters are loaded from the file during the alignment process.

To facilitate alignment over the complete switching range of the equipment, the channel data in the transceiver should first be uploaded to the computer and stored to disk. Alignment channels at the upper, lower and middle band edges should then be downloaded to the trans-

ceiver. The original data can be replaced at the end of the alignment process.

The alignment mode is accessed by "Auto mode" command from the computer when switching on.

Channels	Frequency (Simplex)	
	Ver. A	Ver. C
LOW	134.000	146.000
MID	142.000	160.000
HIGH	150.000	174.000

In the alignment mode, normal operation is suspended. Use the control command from the computer to change the list of test functions.

PLL & Transmitter

Set up the test equipment as shown above for transmitter alignment. Maintain the supply voltage constant at 13.8 V for all steps.

PLL Reference Frequency

Select the MID channel and key the transmitter. Adjust TC1002 on the RF unit, if necessary, so the counter frequency is within 100 Hz of the channel center frequency for the transceiver version. Also verify that the HIGH and LOW channels are also within tolerance.

Note!

Because of the bridge audio amplifier circuit used in the VX-3000V, it is necessary to construct and use a simple audio load test adapter as shown in the schematic diagram above, when conducting receiver alignment steps.

Do not connect either side of the speaker leads to chassis "ground".

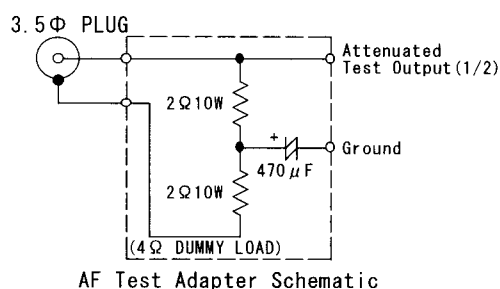

Alignment

Transmitter parameters except PLL Reference Frequency

In the alignment mode, the transmitter parameters are stored by control commands from the computer (Command + Setting Data). The transmitter parameters, commands and data are shown below.

Transmitter parameters

Parameters	Control Command		Data	
	1 st	2 nd	Fixed	Variable
TX Power (HIGH)	C4	—	01	01~FF(h)
TX Power (MID)	C4	—	02	01~FF(h)
TX Power (LOW)	C4	—	03	01~FF(h)
MIC Sensitivity	B4	47	—	01~FF(h)
Microphone Deviation (WIDE)	B4	4D	—	01~FF(h)
Microphone Deviation (NARROW)	B4	6D	—	01~FF(h)
TX CTCSS Deviation (WIDE)	B4	54	—	01~FF(h)
TX CTCSS Deviation (NARROW)	B4	74	—	01~FF(h)
TX DCS Deviation (WIDE)	B4	43	—	01~FF(h)
TX DCS Deviation (NARROW)	B4	63	—	01~FF(h)
TX DTMF Deviation (WIDE)	B4	44	—	01~FF(h)
TX DTMF Deviation (NARROW)	B4	64	—	01~FF(h)
TX 2/5 Tone Deviation (WIDE)	B4	57	—	01~FF(h)
TX 2/5 Tone Deviation (NARROW)	B4	77	—	01~FF(h)
TX FFSK Deviation (WIDE)	B4	46	—	01~FF(h)
TX FFSK Deviation (NARROW)	B4	66	—	01~FF(h)

Receiver parameters

In the alignment mode, the receiver parameters are stored by control commands from the computer (Command + Setting Data). The receiver parameters, commands and data are shown below.

Receiver parameters

Parameters	Control Command		Data	
	1 st	2 nd	Fixed	Variable
SINAD Sensitivity	B4	51	—	01~FF(h)
Squelch (WIDE)	B4	53	—	01~FF(h)
Squelch (NARROW)	B4	73	—	01~FF(h)
AF Out (WIDE)	B4	41	—	01~FF(h)
AF Out (NARROW)	B4	61	—	01~FF(h)
Line Out (WIDE)	B4	4C	—	01~FF(h)
Line Out (NARROW)	B4	6C	—	01~FF(h)
CTCSS Decode	B4	58	—	01~FF(h)
DCS Decode	B4	59	—	01~FF(h)

Component Application

Address	Device name	Description	Application
*** RF-UNIT ***			
Q 1001	G3070194	TRANSISTOR XN1213-(TX)	BPF Select SW
Q 1002	G3115867Y	TRANSISTOR 2SA1586Y	TEMP Compensation
Q 1004	G4070005	FET SGM2016M-T7 (Lot 1-6)	1st Mixer
Q 1004	G4070012	FET SGM2016AM-T7(Lot 7-)	1st Mixer
Q 1005	G3326207B	TRANSISTOR 2SC2620Q	1st IF Amp
Q 1006	G3341167G	TRANSISTOR 2SC4116GR	Noise Amp
Q 1007	G3352268Z	TRANSISTOR 2SC5226	RX RF Amp
Q 1008	G1092616	IC BA4116FV-E2	FM Subsystem
Q 1009	G3115867Y	TRANSISTOR 2SA1586Y	Unlock DET
Q 1010	G3070193	TRANSISTOR UN5215-(TX)	Unlock DET
Q 1012	G3341167G	TRANSISTOR 2SC4116GR	Ripple Filter
Q 1013	G3350198	TRANSISTOR 2SC5019-(TX)	Buffer Amp
Q 1014	G3326300	TRANSISTOR 2SC2630	Final Power Amp
Q 1015	G3325390	TRANSISTOR 2SC2539	Driver
Q 1016	G3347670	TRANSISTOR 2SC4767	Pre Driver
Q 1017	G3352268Z	TRANSISTOR 2SC5226	Buffer Amp
Q 1018	G3805087B	FET 2SK508-T2B K52	RX VCO
Q 1019	G1092541	IC MB15A02PFV1-G-BND-EF	PLL Subsystem
Q 1020	G3070195	TRANSISTOR 2SB1201	APC
Q 1021	G3070192	TRANSISTOR UN5213-(TX)	TX/RX Switch
Q 1022	G3211327Q	TRANSISTOR 2SB1132 (Lot 1-4)	RX +B SW
Q 1022	G3211228S	TRANSISTOR 2SB1122S (Lot 5-)	RX +B SW
Q 1023	G3211327Q	TRANSISTOR 2SB1132 (Lot 1-4)	CNTL 5V REG
Q 1023	G3211228S	TRANSISTOR 2SB1122S (Lot 5-)	CNTL 5V REG
Q 1024	G3211327Q	TRANSISTOR 2SB1132 (Lot 1-4)	PLL 5V REG
Q 1024	G3211228S	TRANSISTOR 2SB1122S (Lot 5-)	PLL 5V REG
Q 1025	G3805087B	FET 2SK508-T2B K52	TX VCO
Q 1026	G1091593	IC TA75S01F TE85R	APC
Q 1027	G3341167G	TRANSISTOR 2SC4116GR	APC
Q 1028	G1092550	IC S-8100BF-SA-T1 (Lot 1-12)	TEMP Sensor
Q 1028	G1092937	IC S-8110AMP-DSB-T1(Lot 13-)	TEMP Sensor
Q 1029	G1092589	IC PST597CNR	Reset
Q 1030	G3341167G	TRANSISTOR 2SC4116GR	PLL REF OSC
Q 1031	G1092431	IC MM1216GNRE	CNTL 5V REG
Q 1032	G1092431	IC MM1216GNRE	PLL 5V REG
Q 1033	G3070194	TRANSISTOR XN1213-(TX)	RX +B SW
Q 1034	G3070192	TRANSISTOR UN5213-(TX)	TX/RX Switch
Q 1035	G3070195	TRANSISTOR 2SB1201STP-FA-TL	TX +B SW
Q 1036	G1091753	IC AN7709	9V REG
Q 1037	G3070194	TRANSISTOR XN1213-(TX)	TX +B SW
Q 1038	G3211327Q	TRANSISTOR 2SB1132 (Lot 1-4)	Base Band 5V REG
Q 1038	G3211228S	TRANSISTOR 2SB1122S (Lot 5-)	Base Band 5V REG
Q 1039	G1092431	IC MM1216GNRE	Base Band 5V REG
Q 1040	G3070192	TRANSISTOR UN5213-(TX)	Power Supply SW
Q 1041	G1091593	IC TA75S01F TE85R	LPF
Q 1042	G3211340R	TRANSISTOR 2SB1134R	Power Supply SW
Q 1043	G1092506	IC TDA1519A	AF Amp
Q 1044	G1090893	IC TC4S66F TE85R	AF Mute
Q 1045	G1092077	IC HD64F3334YF16 (Lot 1-7)	Main Microprocessor
Q 1045	G1092971	IC HD64F3337YF16 (Lot 8-13)	Main Microprocessor
Q 1045	G1093352	IC DF3337YF16 (Lot 14-16)	Main Microprocessor
Q 1045	G1092971	IC HD64F3337YF16 (Lot 17-)	Main Microprocessor
Q 1046	G3070192	TRANSISTOR UN5213-(TX)	AF Mute
Q 1047	G1092182	IC SC11372CQ (Lot 1-4)	AF Base Band

Component Application

Address	Device name	Description	Application
Q 1047	G1092739	IC SC11372CQB1 (Lot 5-)	AF Base Band
Q 1048	G3070194	TRANSISTOR XN1213-(TX)	REF Sift
Q 1049	G3070192	TRANSISTOR UN5213-(TX)	SQ SW
Q 1050	G3211327Q	TRANSISTOR 2SB1132 (Lot 1-4)	Option SW
Q 1050	G3211228S	TRANSISTOR 2SB1122S (Lot 5-)	Option SW
Q 1051	G3070192	TRANSISTOR UN5213-(TX)	Option SW
Q 1052	G1092480	IC LC7385M-TE-R	DTMF Decoder
Q 1053	G1092512	IC NM93C86AM8(TAPING)	EEPROM
Q 1055	G3070194	TRANSISTOR XN1213-(TX)	REF Shift
Q 1056	G3341167G	TRANSISTOR 2SC4116GR	TEMP Compensation
Q 1057	G3070194	TRANSISTOR XN1213-(TX)	Horn
Q 1058	G1092479	IC PST9145NR R59-2243	Voltage Sensor
Q 1059	G3070193	TRANSISTOR UN5215-(TX)	TX/RX Switch
Q 1060	G3070193	TRANSISTOR UN5215-(TX)	Power Supply SW
D 1001	G2070536	DIODE MA143-(TX)	Protector
D 1002	G2070536	DIODE MA143-(TX)	Noise DET
D 1003	G2070536	DIODE MA143-(TX)	Noise DET
D 1004	G2070380	DIODE HVU350-TR	BPF
D 1005	G2070380	DIODE HVU350-TR	BPF
D 1006	G2070534	DIODE MA142WK-(TX)	BPF Select SW
D 1007	G2070534	DIODE MA142WK-(TX)	BPF Select SW
D 1008	G2070380	DIODE HVU350-TR	BPF
D 1009	G2070380	DIODE HVU350-TR	BPF
D 1010	G2070394	DIODE 1SS353 TE-17 (Lot 1-2)	Protector
D 1010	G2070470	DIODE 1SS355 TE-17 (Lot 3-)	Protector
D 1012	G2070536	DIODE MA143-(TX)	Protector
D 1013	G2070562	DIODE UM9957F/TR	ANT SW
D 1014	G2070394	DIODE 1SS353 TE-17 (Lot 1-2)	Pre Amp REG
D 1014	G2070470	DIODE 1SS355 TE-17 (Lot 3-)	Pre Amp REG
D 1015	G2070394	DIODE 1SS353 TE-17 (Lot 1-2)	Pre Drive REG
D 1015	G2070470	DIODE 1SS355 TE-17 (Lot 3-)	Pre Drive REG
D 1016	G2070562	DIODE UM9957F/TR (Lot 5-)	ANT SW
D 1017	G2070534	DIODE MA142WK	Protector
D 1018	G2070516	DIODE UM9401F/TR (Lot 5-)	ANT SW
D 1019	G2070438	DIODE RD6.8UMB2-T1B	REG
D 1020	G2070380	DIODE HVU350-TR	RX VCO Tune
D 1021	G2070380	DIODE HVU350-TR	RX VCO Tune
D 1022	G2070380	DIODE HVU350-TR	RX VCO Tune
D 1023	G2070380	DIODE HVU350-TR	RX VCO Tune
D 1024	G2070080	DIODE 1SS319 TE85R	RF Power DET
D 1025	G2070394	DIODE 1SS353 TE-17 (Lot 1-2)	CNTL 5V SW
D 1025	G2070470	DIODE 1SS355 TE-17 (Lot 3-)	CNTL 5V SW
D 1026	G2070114	DIODE 1T363-01-T8A	TX VCO Tune
D 1027	G2070114	DIODE 1T363-01-T8A	TX VCO Tune
D 1028	G2070380	DIODE HVU350-TR	REF Tune
D 1031	G2070380	DIODE HVU350-TR	TX VCO
D 1032	G2070380	DIODE HVU350-TR	DCS MOD
D 1033	G2070536	DIODE MA143-(TX)	Protector
D 1034	Q9000534	SURGE ABSORBER P6KE18 (Lot 1-4)	+B REG
D 1034	Q9000721	SURGE ABSORBER P6KA18 (Lot 5-)	+B REG
D 1035	G2070536	DIODE MA143-(TX)	Protector
D 1036	G2070536	DIODE MA143-(TX)	Power Supply SW
D 1037	G2070536	DIODE MA143-(TX)	Power Supply SW
D 1038	G2070536	DIODE MA143-(TX)	Protector
D 1039	G2070536	DIODE MA143-(TX)	Protector
D 1040	G2070536	DIODE MA143-(TX)	Protector

Component Application

Address	Device name	Description	Application
D 1041	G2070536	DIODE MA143-(TX)	Protector
D 1042	G2070536	DIODE MA143-(TX)	Protector
D 1043	G2070536	DIODE MA143-(TX)	Protector
D 1044	G2070536	DIODE MA143-(TX)	Protector
D 1045	G2070536	DIODE MA143-(TX)	Protector
D 1046	G2070536	DIODE MA143-(TX)	Protector
D 1047	G2070536	DIODE MA143-(TX)	Protector
D 1048	G2070536	DIODE MA143-(TX)	Protector
D 1049	G2070536	DIODE MA143-(TX)	Protector
D 1050	G2070536	DIODE MA143-(TX)	Protector
D 1051	G2070536	DIODE MA143-(TX)	Protector
D 1052	G2070062	DIODE 02CZ5.1Y TE85R	REG
D1053	G2070470	DIODE 1SS355 (Lot 5-)	Protector
D1054	G2070470	DIODE 1SS355 (Lot 5-)	Protector
D1055	G2070470	DIODE RLS135 (Lot 5-)	Protector
D1056	G2070536	MA143 (Lot 5-)	Protector
D1057	G2070722	HZM5.6NB2 TR (Lot 13-)	REG
*** FRONT-A-UNIT ***			
Q5001	G1091305	IC NJM78L09UA TE2	9V REG
Q5002	G1092531	IC HD4074849TF(NO PROG.)	Microprocessor
Q5003	G1091325	IC NJM78L05UA TE2	5V REG
Q5004	G3070194	TRANSISTOR XN1213-(TX)	REF Shift
Q5005	G1092588	IC PST596CNR	Reset
Q5006	G3070192	TRANSISTOR UN5213-(TX)	EXT Amp Mute
Q5007	G3070192	TRANSISTOR UN5213-(TX)	Clone SW
D 5001	G2090692	LED HLMF-KL05	LED
D 5002	G2090692	LED HLMF-KL05	LED
D 5003	G2070536	DIODE MA143-(TX)	Protector
D 5004	G2070536	DIODE MA143-(TX)	Protector
D 5005	G2070536	DIODE MA143-(TX)	Protector
D 5006	G2070536	DIODE MA143-(TX)	Protector
D 5007	G2070536	DIODE MA143-(TX)	Protector
D 5008	G2070536	DIODE MA143-(TX)	Protector
D 5009	G2070536	DIODE MA143-(TX)	Protector
D 5010	G2070536	DIODE MA143-(TX)	Protector
D 5011	G2070536	DIODE MA143-(TX)	Protector
D 5012	G2070536	DIODE MA143-(TX)	Protector
D 5013	G2070536	DIODE MA143-(TX)	Protector
D 5014	G2070536	DIODE MA143-(TX)	Protector
D 5015	G2070536	DIODE MA143-(TX)	Protector
DS5001	G6090126	LCD DLC-7991	Protector
*** FRONT-B-UNIT ***			
Q6001	G3070196	TRANSISTOR UN511L-(TX)	LED Driver
Q6002	G3070196	TRANSISTOR UN511L-(TX)	LED Driver
Q6003	G1092619	IC HD4074394FP(NO PROG.)	Microprocessor
Q6005	G1091305	IC NJM78L09UA TE2	9V REG
Q6006	G1092588	IC PST596CNR	Reset
Q6007	G1091325	IC NJM78L05UA TE2	5V REG
Q6008	G3070194	TRANSISTOR XN1213-(TX)	REF Shift
Q6009	G3070192	TRANSISTOR UN5213-(TX)	EXT Amp Mute
Q6010	G3070192	TRANSISTOR UN5213-(TX)	Clone SW
D 6001	G2070536	DIODE MA143-(TX)	LED

Component Application

Address	Device name	Description	Application
D 6002	G2090696	LED HLMP-1540	LED
D 6003	G2050016	LED SPR-325MVWT31	LED
D 6004	G2090696	LED HLMP-1540	LED
D 6005	G2090696	LED HLMP-1540	LED
D 6006	G2090695	LED HLMP-1440	LED
D 6007	G2090696	LED HLMP-1540	LED
D 6008	G2090695	LED HLMP-1440	LED
D 6009	G2070536	DIODE MA143-(TX)	Protector
D 6010	G2070536	DIODE MA143-(TX)	Protector
D 6011	G2070536	DIODE MA143-(TX)	Protector
D 6012	G2070536	DIODE MA143-(TX)	Protector
D 6013	G2070536	DIODE MA143-(TX)	Protector
D 6014	G2070536	DIODE MA143-(TX)	Protector
D 6015	G2070536	DIODE MA143-(TX)	Protector
D 6016	G2070536	DIODE MA143-(TX)	Protector
D 6017	G2070536	DIODE MA143-(TX)	Protector

Circuit Description

RECEIVER

1. Receive Signal Path

Incoming signals from the antenna jack within the frequency range of the transceiver are delivered to the RF UNIT and pass through a low-pass filter and band-pass filter consisting of coils L1016, L1017, L1018, L1009, L1005 & L1006, capacitors C1094, C1104, C1105, C1107, C1108, C1072, C1032, C1043, C1033, C1034, C1020, C1016, C1035, C1044 & C1036, and antenna switching diode D1013 (**UM9957F**).

The RF signal is then amplified by Q1007 (**2SC5226**) and filtered by a varactor-tuned band-pass filter consisting of coils L1004 & L1031, capacitors C1038, C1028, C1029, C1124, C1164, C1030 & C1039, and diodes D1004 & D1005 (both **HVU350**) before application to first mixer Q1004 (**SGM2016M**).

Buffered output from Receive VCO Q1018 (**2SK508**) is amplified by Q1017 (**2SC5226-4/5**) to provide a pure first local signal between 112.6 and 152.6 MHz for injection to first mixer Q1004 (**SGM2016M**) along with the amplified receive RF signal. The 21.4-MHz first mixer product then passes through monolithic crystal filters XF1001 & XF1002 (**21S102A**, 10-kHz BW) to strip away all but the desired signal, which is then amplified by Q1005 (**2SC2620**) before application to FM IF subsystem IC Q1008 (**TA31136FN**), which contains the second mixer, second local oscillator, limiter amplifier, noise amplifier, and S-meter amplifier.

The 455-kHz second local signal is derived from 20.945-MHz crystal X1001 for mixing with the first IF signal within Q1008. The resulting second IF passes through ceramic filter CF1001 (**PBFS455P9DR**) or CF1002 (**PBFS455P12DR**)

to strip away unwanted mixer products, and is applied to the limiter amplifier in Q1008 to remove amplitude variations in the 455-kHz IF before demodulation by ceramic discriminator CD1001 (**CDBC450C24X**).

Detected audio from Q1008 is applied to Baseband Audio Coprocessor Q1047 (**SC11372**) for de-emphasis and band-pass filtering, and then via the volume control to audio amplifier Q1043 (**TDA1519A**), providing up to 10 watts receiver audio output to the optional external speaker jack or internal 4- Ω loudspeaker.

2. Squelch Control

The squelch circuitry consists of a noise amplifier & band-pass filter within Q1008, and amplifier Q1006 (**2SC4116**) before noise detector D1002/D1003 (**MA143**).

When no carrier is received, noise at the output of the detector stage in Q1008 is amplified and band-pass filtered by the noise amplifier within Q1008 and the network between pins 7 and 8. The resulting high-frequency noise is amplified by Q1006 before rectification by D1002/D1003, and the resulting DC squelch control voltage is applied to A/D converter input pin 30 of microprocessor Q1045 (**HD64F3334YF16**). When no carrier is received, this signal causes pin 52 of Q1045 to go low, and pin 53 of Q1045 to go high. Pin 53 turns on Q1046 (**UN5213**) ON to mute audio amplifier Q1043, while pin 52 opens squelch gate Q1044 (**TC4S66F**) to remove input from the audio amplifier. Thus, the microprocessor inhibits output from the audio amplifier, silencing the receiver when no signal is being received, and during transmission.

When a carrier appears at the discriminator,

Circuit Description

noise is suppressed from the squelch control voltage applied to the A/D converter in (Q1045), causing pin 52 of Q1045 to go high, and pin 53 to go low, closing squelch gate Q1044 and unmuting audio amplifier Q1043 by turning Q1046 OFF, respectively.

Demodulated receive audio from Q1008 is de-emphasized and amplified by the de-emphasis amplifier section of Q1047, and then band-pass filtered by the band-pass filter section of Q1047. If the audio was scrambled by voice-band inversion at the transmitter, it is descrambled by the voice-band inverter section within Q1047 to recover clear speech.

If a received signal contains a subaudible tone or ANI code sequence, it is detected by Baseband Audio Coprocessor Q1047 and compared to the tone or code stored in microprocessor Q1045. If the received tone or code matches that programmed, the microprocessor stops scanning, if active, and allows audio to pass through audio amplifier Q1043 to the loudspeaker.

TRANSMITTER

1. Transmit Signal Path

Speech input from the microphone is delivered from the FRONT UNIT to Baseband Audio Coprocessor Q1047 (**SC11372**) on the RF UNIT, which includes microphone amplifier, pre-emphasis, limiter and low-pass filter stages for transmit audio.

After pre-emphasis, the limiter amplifier within Q1047 applies IDC (Instantaneous Deviation Control) and splatter filtering to the speech signal, to suppress any high-frequency audio components that could result in over-

deviation.

The processed audio from Q1047 is applied through Q1041 (**TA7550IF**) to varactor D1031 (**HVU350**), which frequency modulates transmit PLL VCO Q1025 (**2SK508-K52**) oscillating at the transmitting frequency up to ± 2.5 or ± 5 kHz from the unmodulated carrier.

If a CDCSS or CTCSS code is enabled for transmission, the modulating code is generated by microprocessor Q1045 and Baseband Audio Coprocessor Q1047 and applied to varactor D1032 (**HVU350**) to modulate 14.4-MHz PLL reference oscillator Q1030 (**2SC4116GR**) so as to produce the desired tones in the transmit PLL VCO output.

If DTMF is enabled for transmission, the tones are applied to the splatter filter section of Baseband Audio Coprocessor Q1047 instead of the speech audio. The DTMF tones are also amplified for monitoring in the loudspeaker.

The modulated signal from transmit PLL VCO Q1025 (**2SK508**) is buffered by Q1017 (**2SC5226**) and then amplified by Q1013 (**2SC5019**), predriver Q1016 (**2SC4767**), driver Q1015 (**2SC2539**) and finally RF power amplifier Q1014 (**2SC2630**) up to 45 watts.

2. Automatic Power Control (APC)

RF output from the final amplifier is sampled by C1106 and C1109 and rectified by D1024 (**1SS319**). The resulting DC is applied to comparator Q1026 (**TA75S01**) along with power control DC voltage from microprocessor Q1045. Output voltage from the comparator is amplified by Q1027 (**2SC4116**) to regulate the supply voltage to predriver Q1016 through Q1020

Circuit Description

(**2SB1182**), controlling the gain of the predriver so as to maintain the RF power output determined by the power control voltage from the microprocessor. The microprocessor allows selecting either high, or one of two low power levels.

3. Transmit Inhibit

When the transmit PLL is unlocked, pin 7 of PLL chip Q1019 goes to a logic low, switching Q1009 (**2SA1586**) so that Q1010 (**UN5215**) output goes high. The resulting DC unlock control voltage is applied to pin 14 of microprocessor Q1045. While the transmit PLL is unlocked, pin 62 of Q1045 remains high, inhibiting supply of power to the transmit circuitry by supply switch Q1037 (**XN1213**) and Q1035 (**2SB1201**).

4. Spurious Suppression

Generation of spurious products by the transmitter is minimized by the fundamental carrier frequency being equal to the final transmitting frequency, modulated directly in the transmit VCO. Harmonic spurious suppression is provided by a low-pass filter consisting of L1016, L1017 & L1018 and C1104, C1105, C1107 & C1108, resulting in more than 60 dB of harmonic suppression prior to delivery to the antenna.

5. PLL Frequency Synthesizer

5-1. Frequency Reference

Stability is maintained by a regulated 5-V supply Q1024 & Q1032 (**2SB1132** & **MM1216**). Supply voltage to 14.4-MHz reference crystal X1001 is temperature compensated by thermistor TH1001 (**NTCCM20123NH153**) and Q1055 (**2SC4116**) at high temperatures, and thermistor

TH1002 (**NTCCM20123SH223**) and Q1002 (**2SA1586**) at low temperatures.

5-2. Synthesizer

PLL circuitry on the RF UNIT consists of Receive VCO Q1018 (**2SK508**), Transmit VCO Q1025 (**2SK508**), VCO buffer Q1017 (**2SC5226**), and PLL subsystem IC Q1019 (**MB15A02**), which contains a reference divider, serial-to-parallel data latch, programmable divider, phase comparator and charge pump.

During receive, Receive VCO Q1018 (**2SK508**) oscillates between 112.6 and 152.6 MHz according to the transceiver version and the programmed receiving frequency. A sample of the VCO output buffered by Q1017 is applied to the prescaler section at pin 8 of Q1019. There the VCO signal is divided by 64 or 65 and 128 or 129, according to a control signal from the data latch section of Q1019, before being applied to the programmable divider section.

The data latch section of Q1019 also receives serial dividing data from microprocessor Q1047, which causes the pre-divided VCO signal to be further divided in the programmable divider section, depending upon the desired receive frequency, so as to produce a 5-, 6.25- or 7.5-kHz derivative of the VCO frequency. Meanwhile, the reference divider section of Q1019 divides the 14.4-MHz reference from oscillator Q1030 (**2SC4116GR**) to produce a reference signal corresponding to the PLL derivative.

The 5-, 6.25- or 7.5-kHz signal from the programmable divider (derived from the VCO) and that derived from the reference oscillator are applied to the phase detector section of Q1019, which produces a pulsed output with pulse duration depending on the phase difference

Circuit Description

between the input signals. This pulse train is filtered to DC and applied to varactors D1020, D1021, D1022 and D1023 (all **HVU350**). Changes in the level of the DC voltage applied to the varactors affects the reactance in the tank circuit of the VCO, changing the oscillating frequency of the VCO according to the phase difference between the signals derived from the VCO and the crystal reference oscillator. The VCO is thus phase-locked to the crystal reference oscillator.

The output of Receive VCO Q1030, after buffering by Q1017, is applied to the first mixer as described previously.

During transmission, Transmit VCO Q1025 oscillates between 134 and 174 MHz according to the version and programmed transmit frequency. The remainder of the PLL circuitry is shared with the receiver. However, the dividing data from the microprocessor is such that the VCO frequency is at the actual transmit frequency (rather than offset for IFs, as in the receiving case). Also, the VCO is modulated by speech audio applied to D1031 (**HVU350**), as described previously.

Block Diagram

VX-3000V 4ch Front Block Diagram

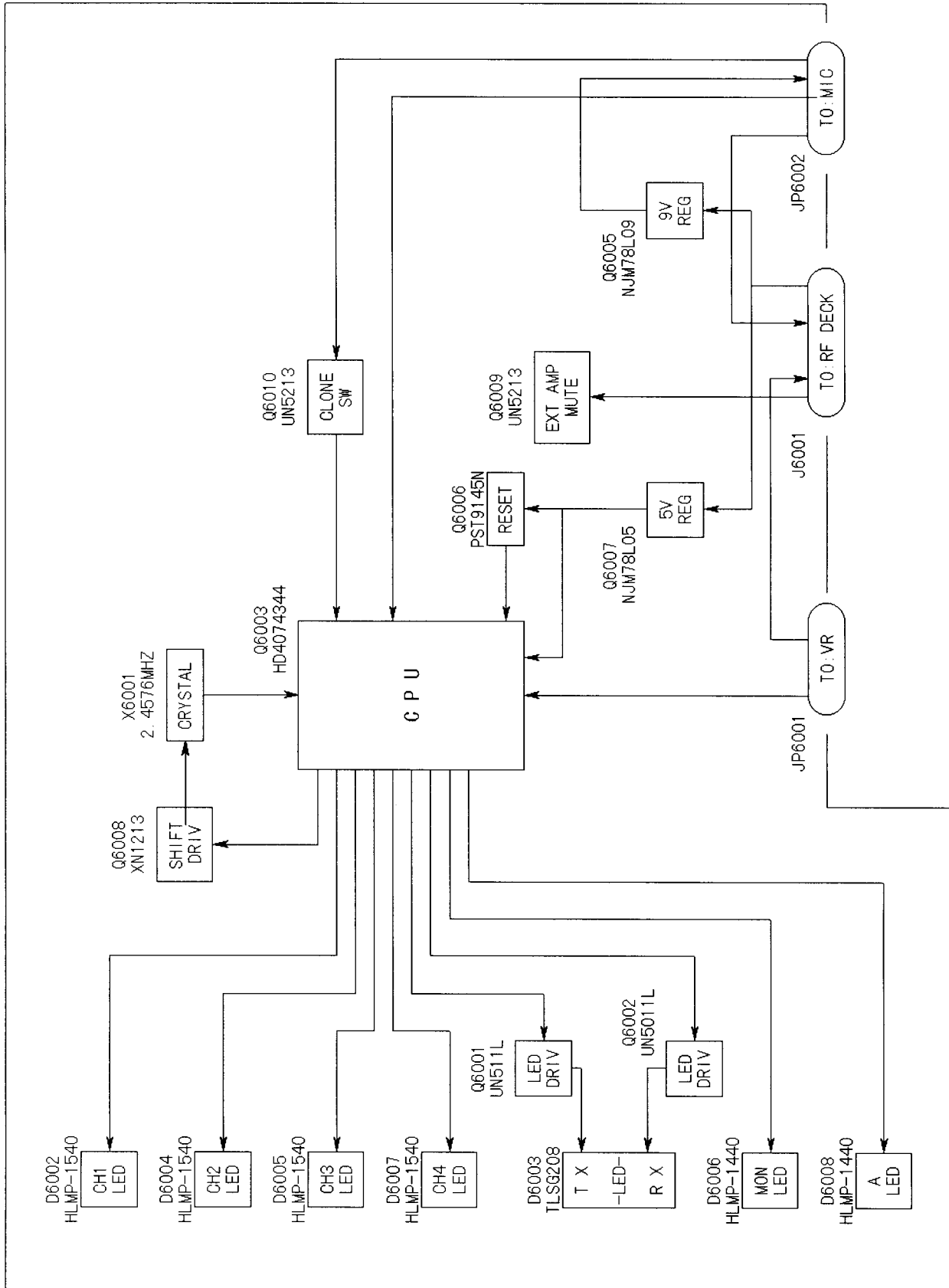

Block Diagram

VX-3000V 48ch Front Block Diagram

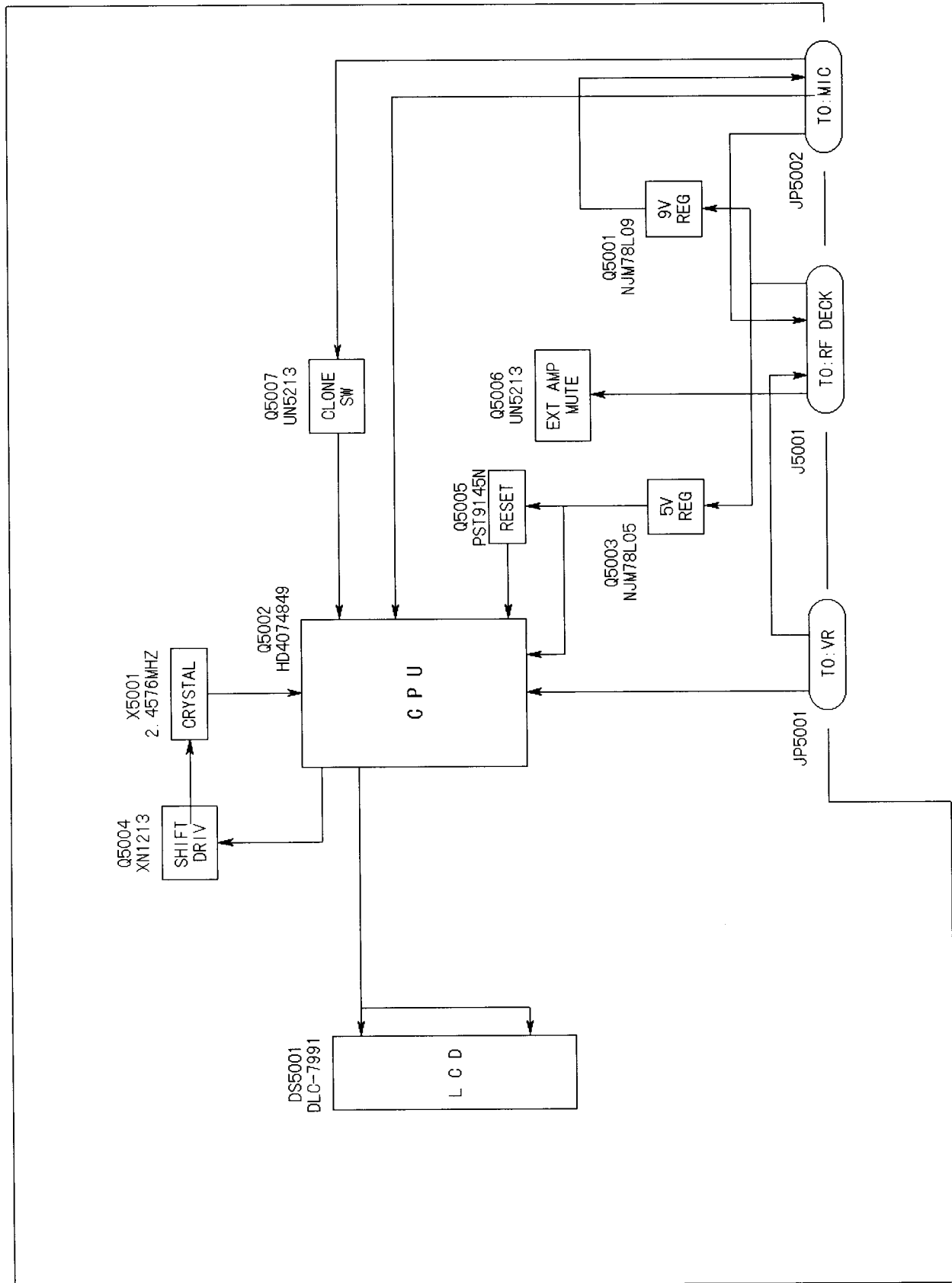

Block Diagram

VX-3000V RF Unit Block Diagram

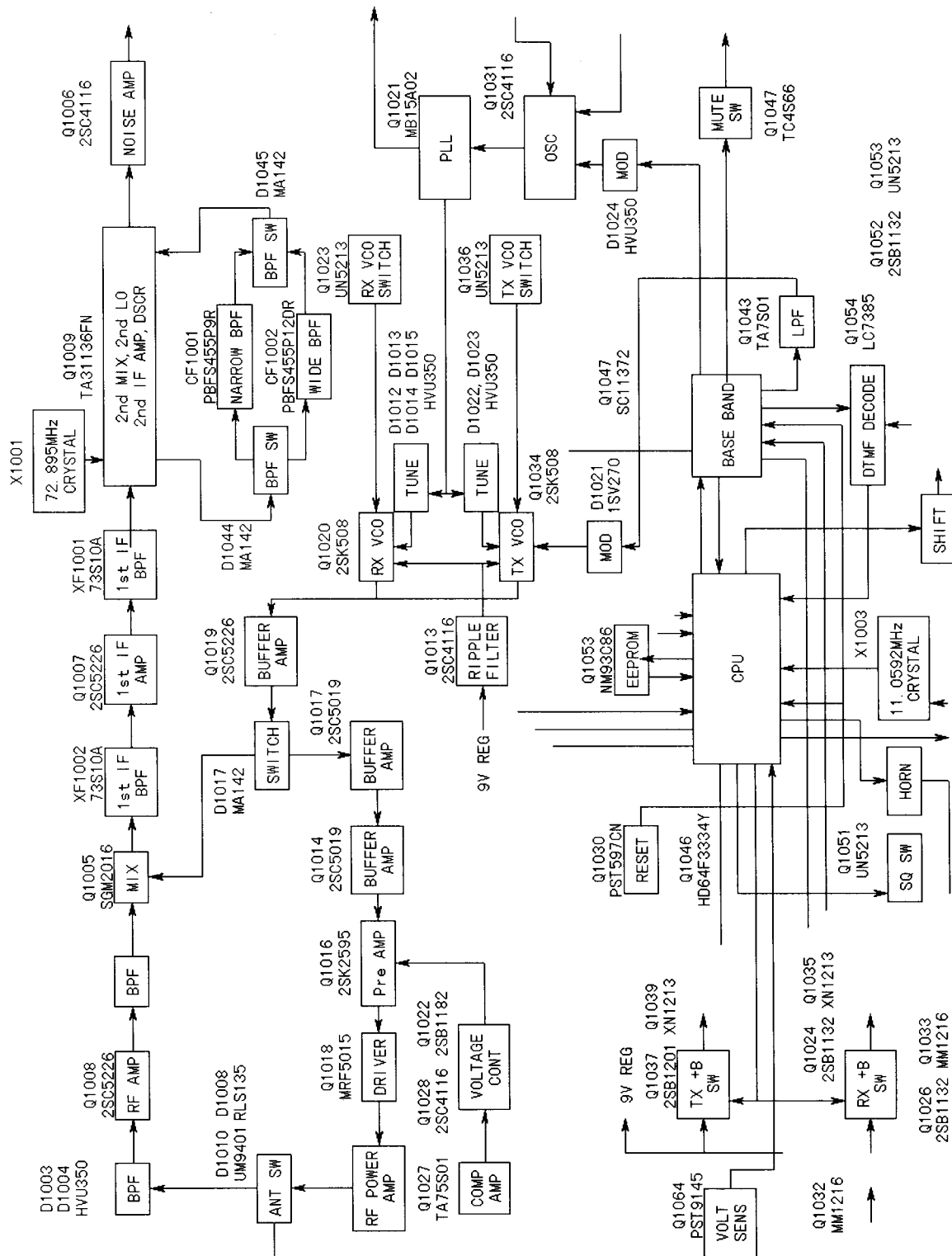

RF Unit

Notes:

Parts Layout

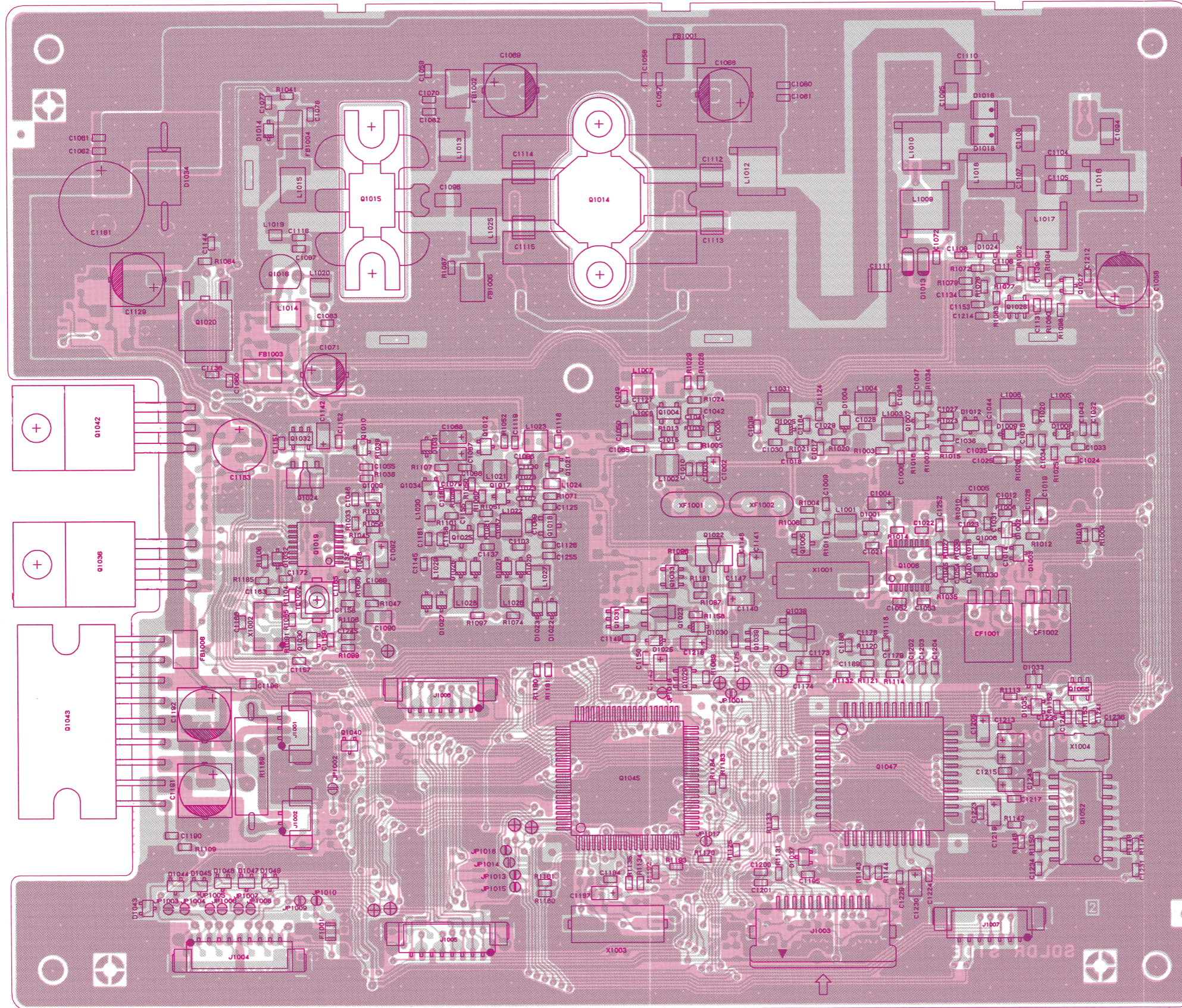

Component Side

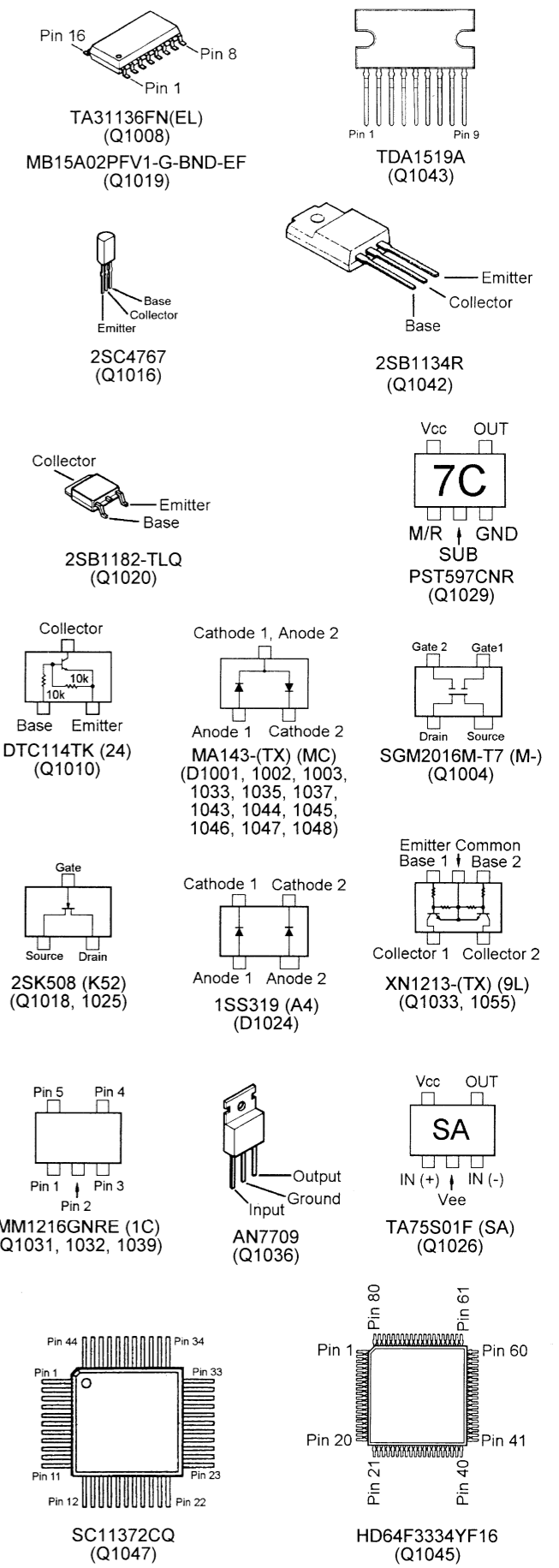
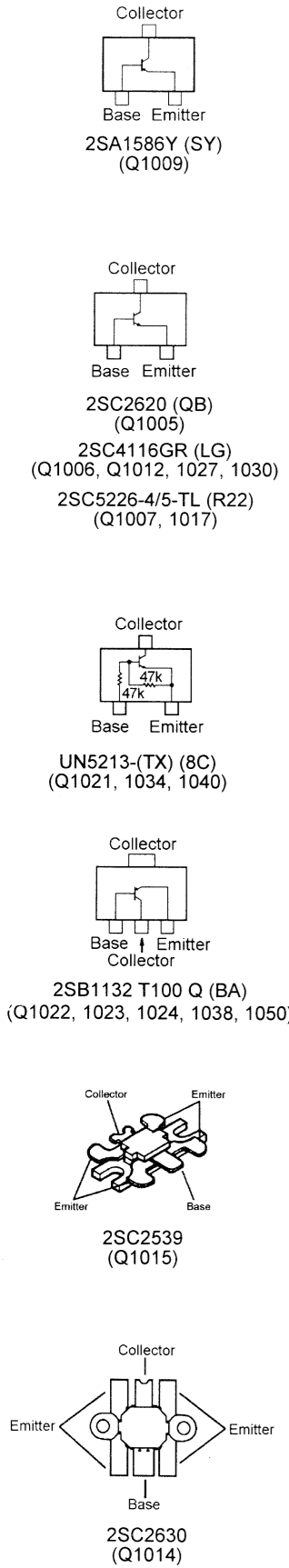

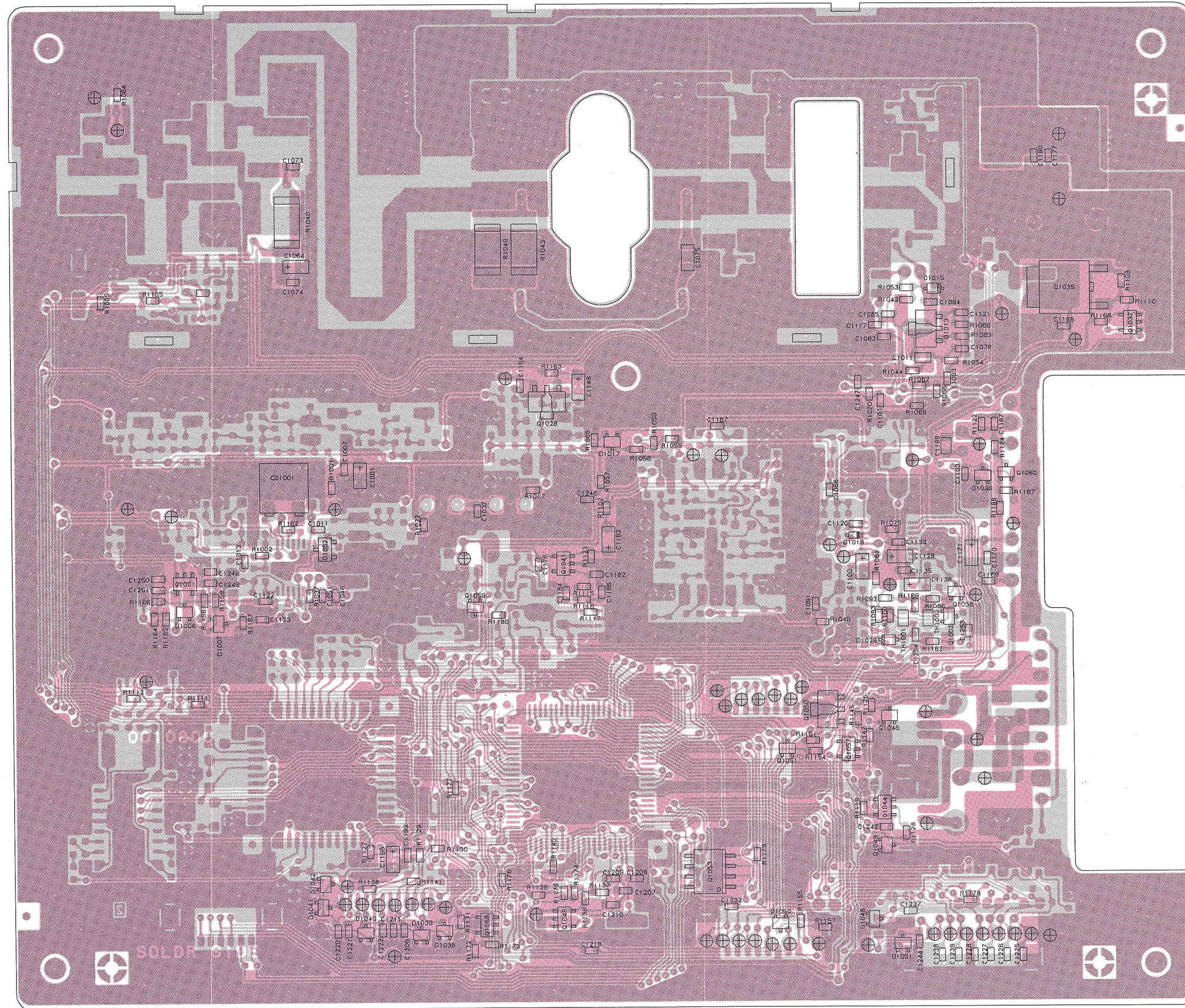
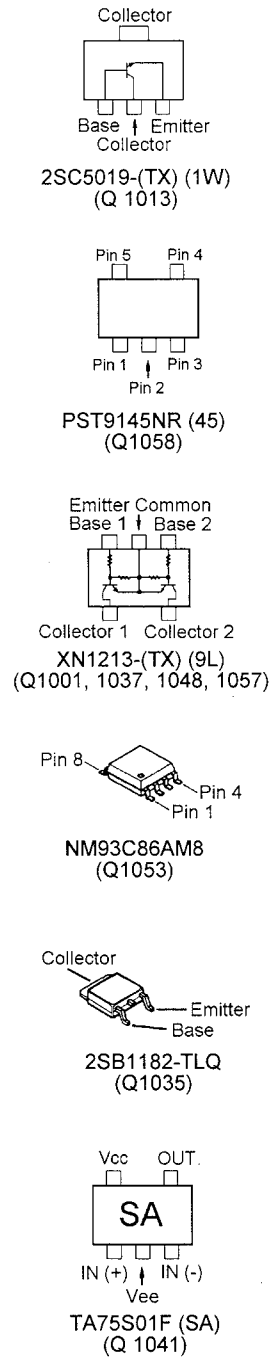

Chip Side

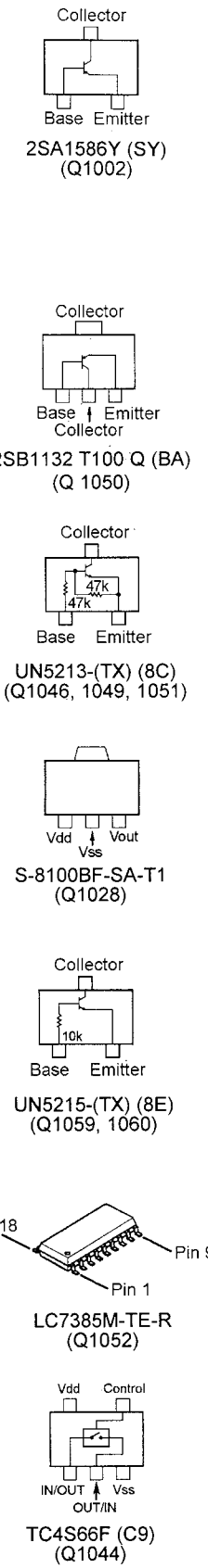

Circuit Diagram

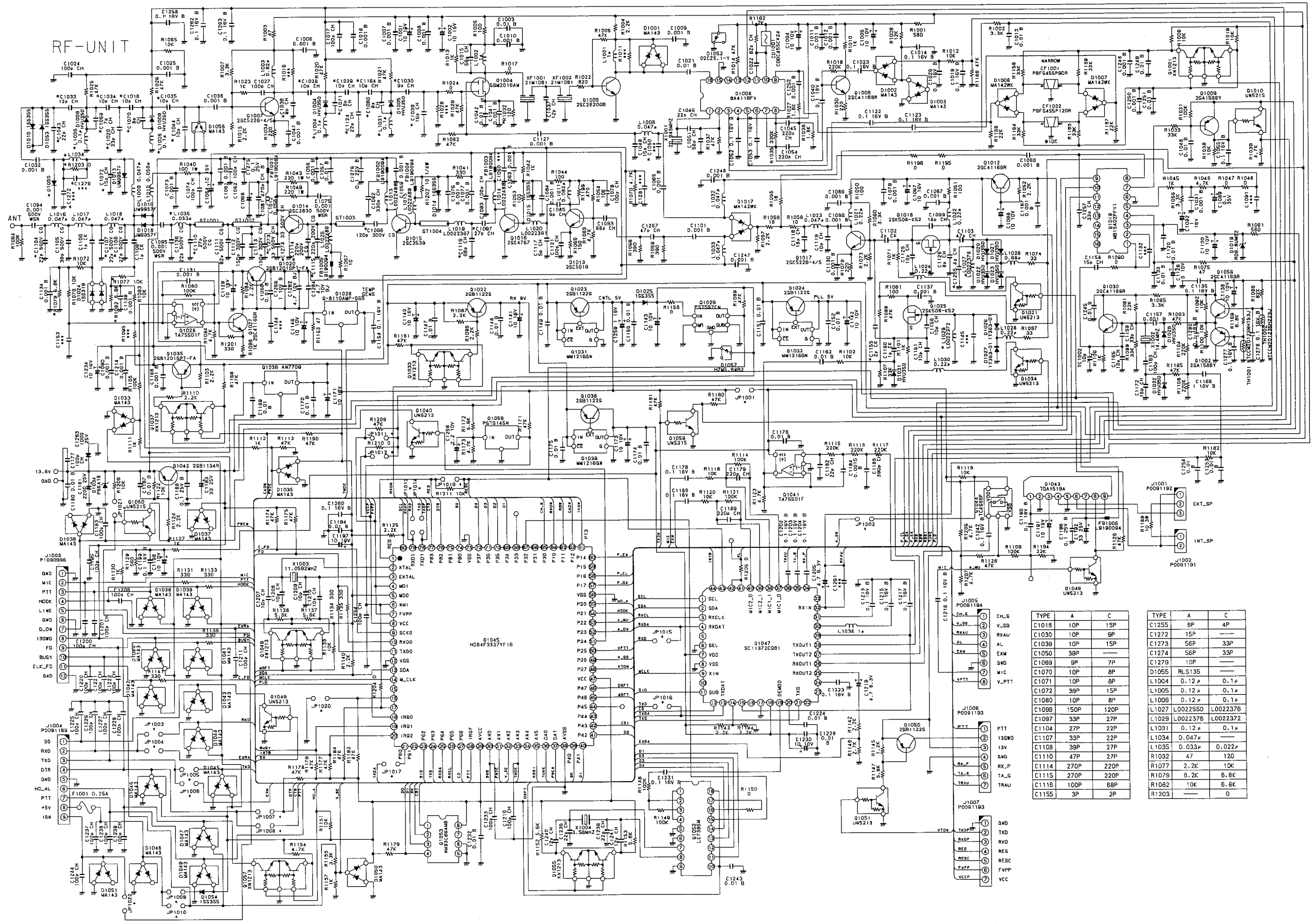

TYPE	A	C
C1018	10P	15P
C1030	10P	5P
C1039	10P	15P
C1050	39P	
C1069	8P	7P
C1070	10P	8P
C1071	10P	8P
C1072	39P	15P
C1080	10P	8P
C1098	150P	120P
C1097	39P	27P
C1104	27P	22P
C1107	39P	22P
C1108	39P	27P
C1110	47P	27P
C1114	270P	220P
C1115	270P	220P
C1118	100P	68P
C1155	3P	2P

TYPE	A	C
C1255	8P	4P
C1272	15P	
C1273	56P	33P
C1274	56P	33P
C1279	10P	
D1055	RLS135	
L1004	0.12µ	0.1µ
L1005	0.12µ	0.1µ
L1006	0.12µ	0.1µ
L1027	L0022550	L0022376
L1029	L0022376	L0022372
L1031	0.12µ	0.1µ
L1034	0.047µ	
L1035	0.033µ	0.022µ
R1032	47	120
R1077	2.2K	10K
R1079	0.2K	6.8K
R1082	10K	6.8K
R1203		D

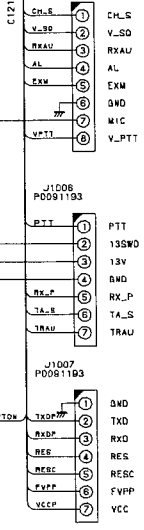

Notes:

Notes:

Parts Layout

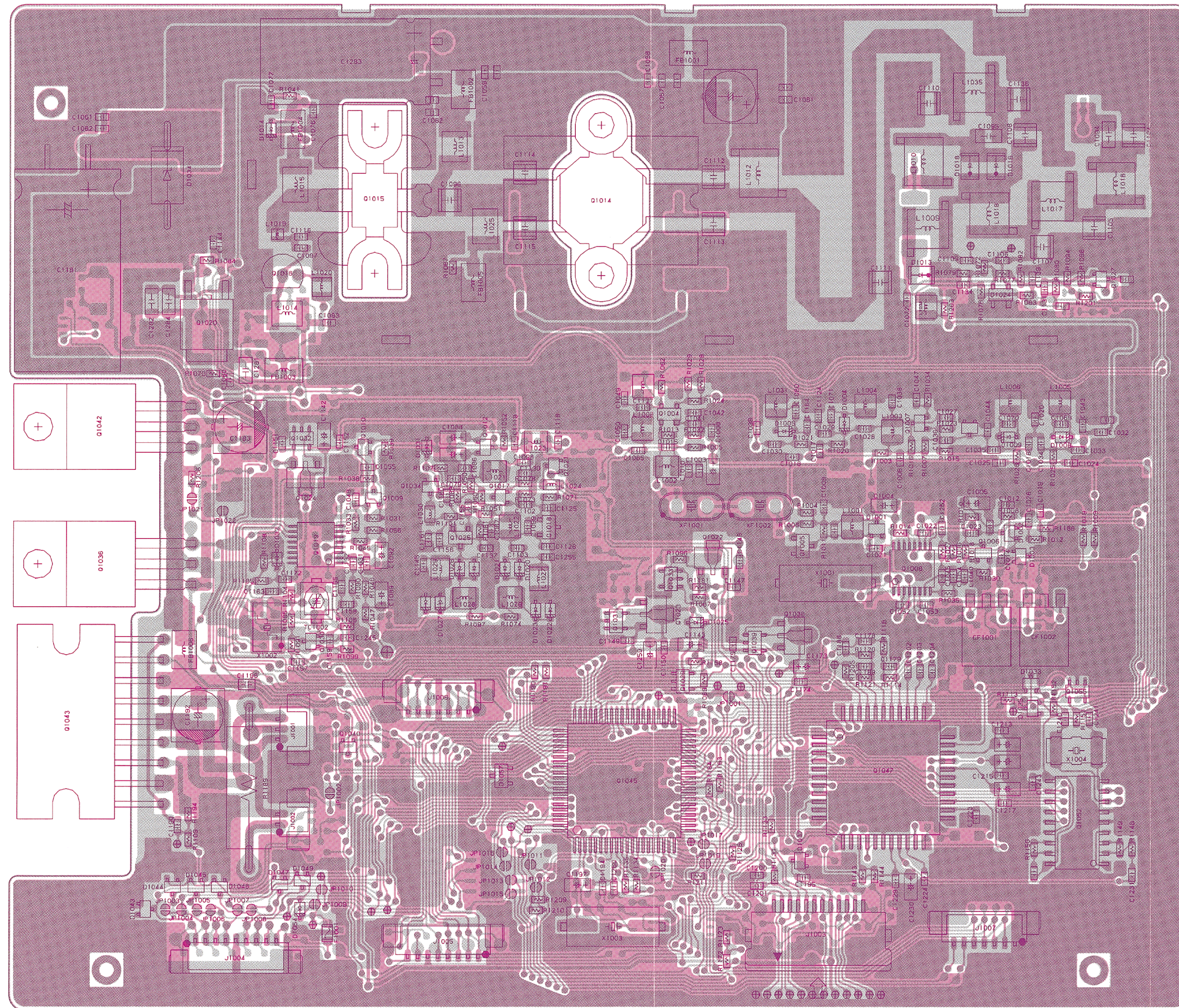
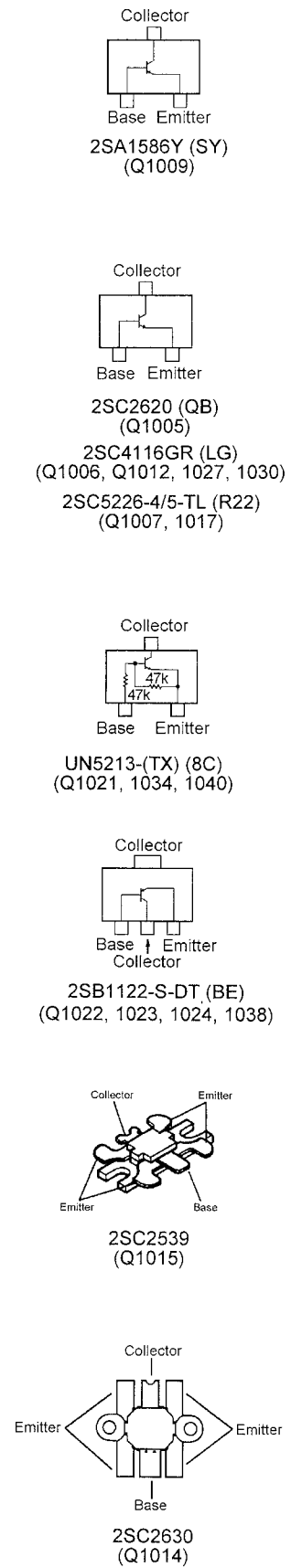

Component Side

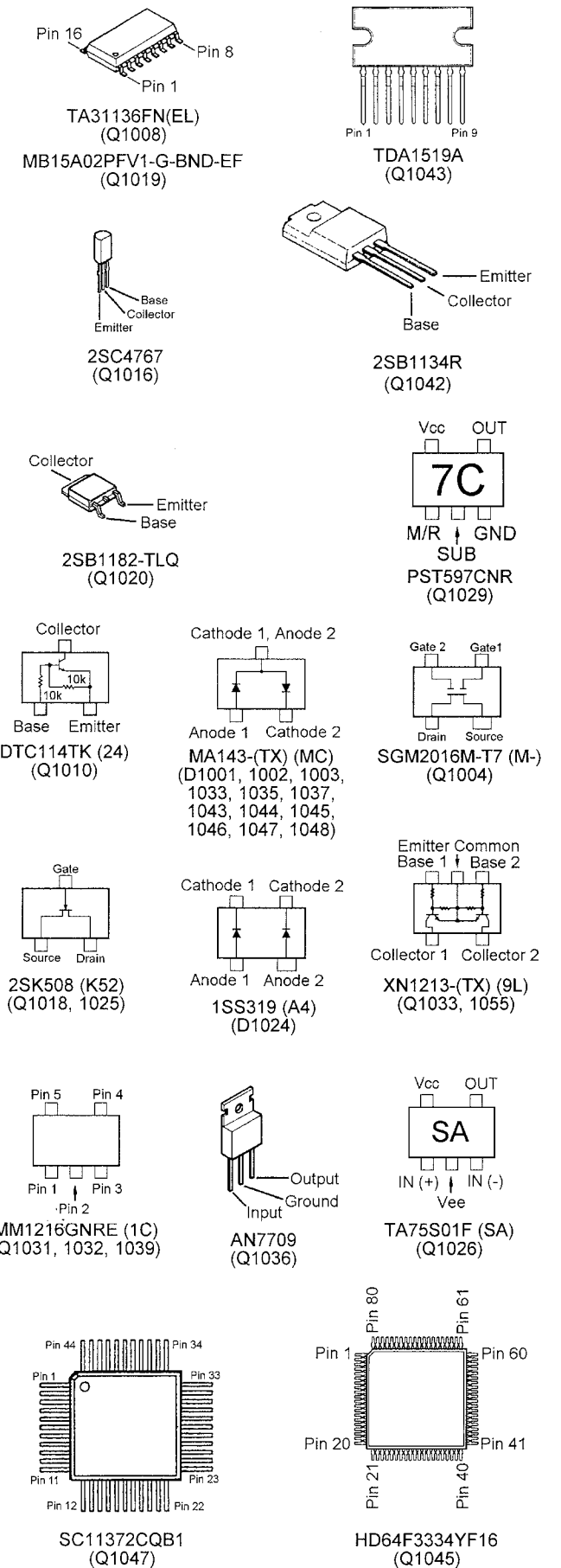

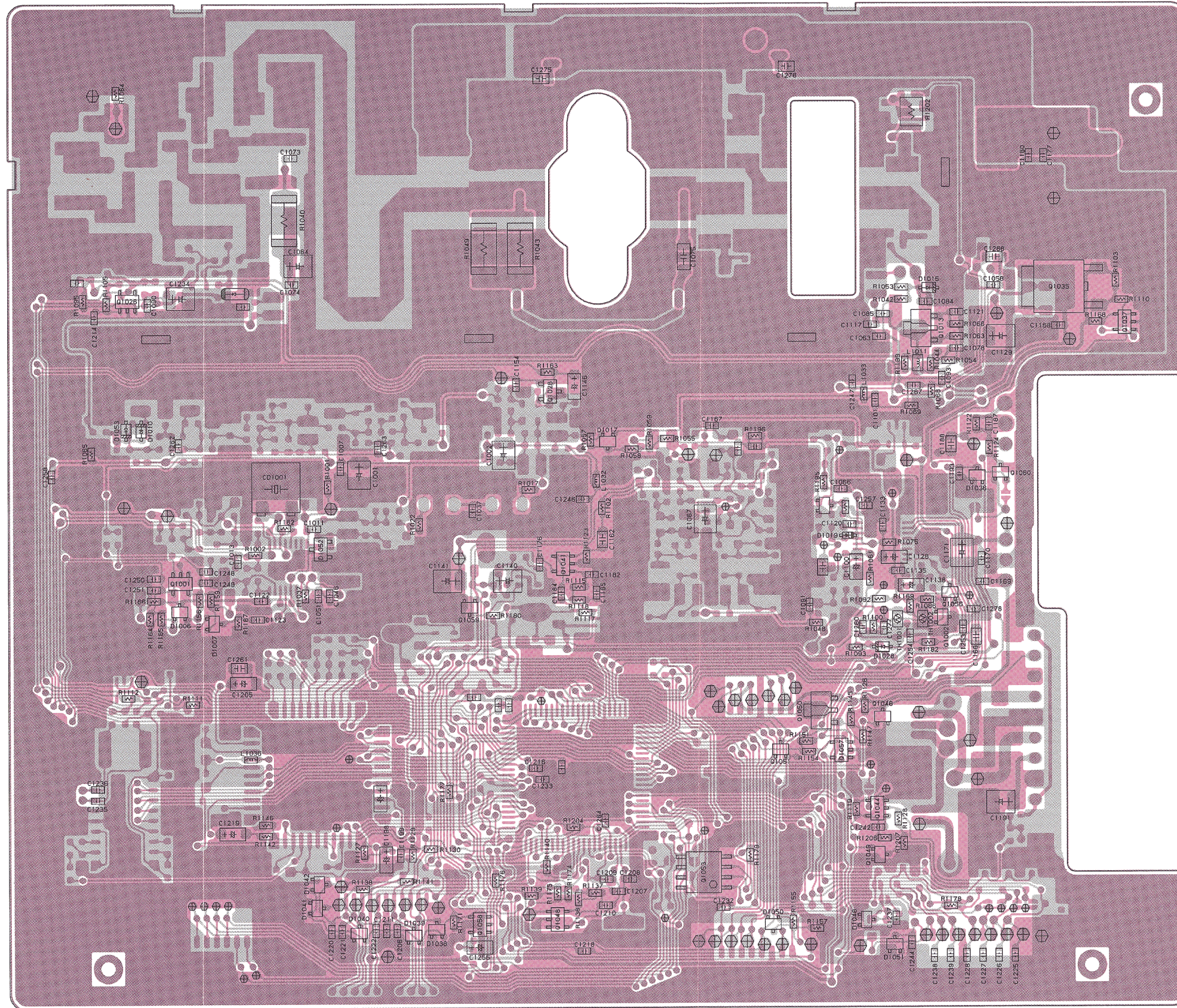
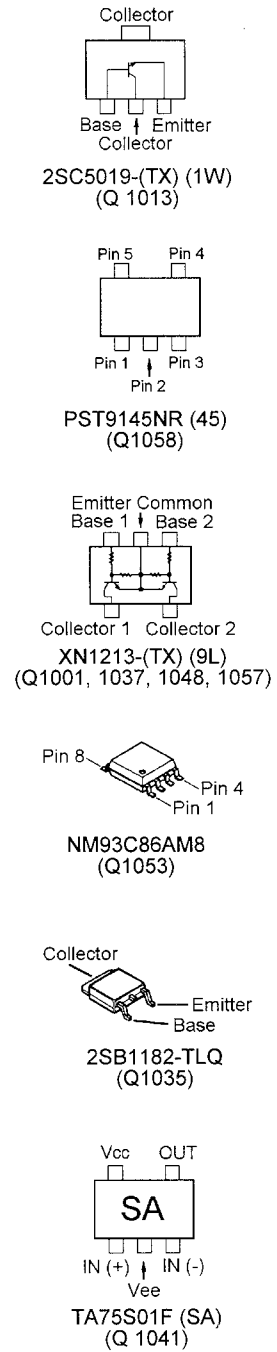

Chip Side

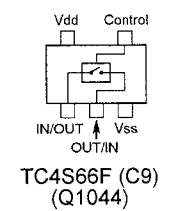
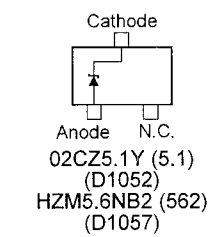
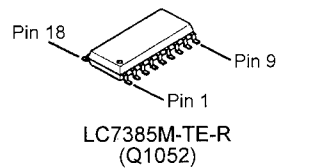
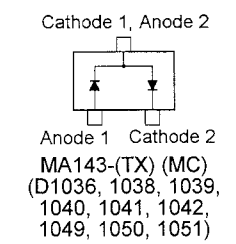
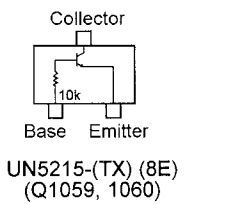
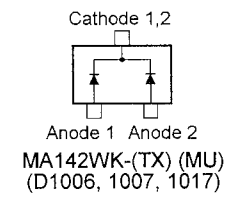
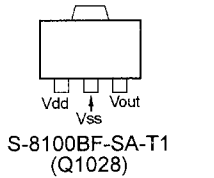
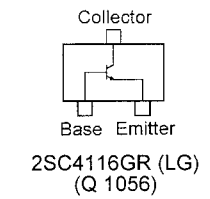
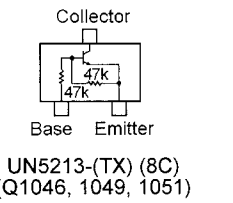
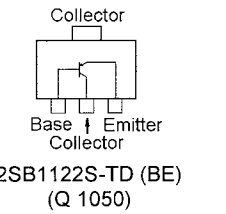
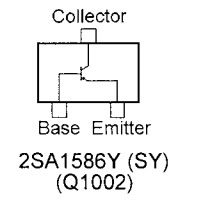

Parts List

REF.	DESCRIPTION	VALUE	V/W	TOL.	MFGR'S DESIG	VXSTD P/N	VERS.	LOT.
*** RF UNIT ***								
	PCB with Component					CS1545001		1-
	PCB with Component					CS1545002	VERSION C	5-
	PCB with Component					CS1545003	VERSION A	1-
	Printed Circuit Board					FR001080C		1-
	Printed Circuit Board					FR001080D		3-
	Printed Circuit Board					FR001080F		5-
	Printed Circuit Board					FR001080G		13-
C 1001	CHIP TA.CAP.	10uF	16V		TEMSVB21C106M-8R	K78120025		5-
C 1001	CHIP TA.CAP.	10uF	10V		TEMSVA1A106M-8R	K78100028		1-
C 1002	CHIP TA.CAP.	10uF	10V		TEMSVA1A106M-8R	K78100028		1-
C 1002	CHIP TA.CAP.	10uF	16V		TEMSVB21C106M-8R	K78120025		5-
C 1003	CHIP CAP.	0.01uF	50V	B	GRM39B103M50PT	K22174823		1-
C 1004	CHIP TA.CAP.	10uF	10V		TEMSVA1A106M-8R	K78100028		1-
C 1005	CHIP TA.CAP.	10uF	10V		TEMSVA1A106M-8R	K78100028		1-
C 1006	CHIP CAP.	0.001uF	50V	B	GRM39B102K50PT	K22174821		1-
C 1007	CHIP CAP.	0.001uF	50V	B	GRM39B102K50PT	K22174821		1-
C 1008	CHIP CAP.	0.001uF	50V	B	GRM39B102K50PT	K22174821		1-
C 1009	CHIP CAP.	0.001uF	50V	B	GRM39B102K50PT	K22174821		1-
C 1010	CHIP CAP.	0.001uF	50V	B	GRM39B102K50PT	K22174821		1-
C 1011	CHIP CAP.	0.001uF	50V	B	GRM39B102K50PT	K22174821		1-
C 1012	CHIP CAP.	0.001uF	50V	B	GRM39B102K50PT	K22174821		1-
C 1013	CHIP CAP.	0.01uF	50V	B	GRM39B103M50PT	K22174823		1-
C 1014	CHIP CAP.	0.1uF	16V	B	GRM39B104K16PT	K22124805		1-
C 1015	CHIP CAP.	56pF	50V	CH	GRM39CH560J50PT	K22174229		1-
C 1016	CHIP CAP.	15pF	50V	CH	GRM39CH150J50PT	K22174215		1-
C 1016	CHIP CAP.	10pF	50V	CH	GRM39CH100D50PT	K22174211	VERSION A	5-
C 1016	CHIP CAP.	15pF	50V	CH	GRM39CH150J50PT	K22174215	VERSION C	5-
C 1017	CHIP CAP.	100pF	50V	CH	GRM39CH101J50PT	K22174235		1-
C 1018	CHIP CAP.	0.001uF	50V	B	GRM39B102K50PT	K22174821		1-
C 1019	CHIP CAP.	0.1uF	16V	B	GRM39B104K16PT	K22124805		3-
C 1019	CHIP CAP.	0.1uF	25V	B	GRM40B104M25PT	K22140811		1-
C 1020	CHIP CAP.	27pF	50V	CH	GRM39CH270J50PT	K22174221		1-
C 1020	CHIP CAP.	27pF	50V	CH	GRM39CH270J50PT	K22174221	VERSION C	5-
C 1020	CHIP CAP.	33pF	50V	CH	GRM39CH330J50PT	K22174223	VERSION A	5-
C 1021	CHIP CAP.	0.01uF	50V	B	GRM39B103M50PT	K22174823		1-
C 1022	CHIP CAP.	82pF	50V	CH	GRM39CH820J50PT	K22174233		1-
C 1023	CHIP CAP.	0.1uF	16V	B	GRM39B104K16PT	K22124805		1-
C 1024	CHIP CAP.	100pF	50V	CH	GRM39CH101J50PT	K22174235		1-
C 1025	CHIP CAP.	0.001uF	50V	B	GRM39B102K50PT	K22174821		1-
C 1026	CHIP CAP.	0.1uF	16V	B	GRM39B104K16PT	K22124805		1-
C 1027	CHIP CAP.	100pF	50V	CH	GRM39CH101J50PT	K22174235		1-
C 1028	CHIP CAP.	47pF	50V	CH	GRM39CH470J50PT	K22174227		1-
C 1028	CHIP CAP.	10pF	50V	CH	GRM39CH100D50PT	K22174211	VERSION A	5-
C 1028	CHIP CAP.	47pF	50V	CH	GRM39CH470J50PT	K22174227	VERSION C	5-
C 1029	CHIP CAP.	15pF	50V	CH	GRM39CH150J50PT	K22174215		1-
C 1029	CHIP CAP.	15pF	50V	CH	GRM39CH150J50PT	K22174215	VERSION C	5-
C 1029	CHIP CAP.	10pF	50V	CH	GRM39CH100D50PT	K22174211	VERSION A	5-
C 1030	CHIP CAP.	15pF	50V	CH	GRM39CH150J50PT	K22174215		1-
C 1030	CHIP CAP.	15pF	50V	CH	GRM39CH150J50PT	K22174215	VERSION C	5-
C 1030	CHIP CAP.	10pF	50V	CH	GRM39CH100D50PT	K22174211	VERSION A	5-
C 1031	CHIP CAP.	0.001uF	50V	B	GRM39B102K50PT	K22174821		1-
C 1032	CHIP CAP.	0.001uF	50V	B	GRM39B102K50PT	K22174821		1-
C 1033	CHIP CAP.	15pF	50V	CH	GRM39CH150J50PT	K22174215		1-
C 1033	CHIP CAP.	12pF	50V	CH	GRM39CH120J50PT	K22174213	VERSION A	5-
C 1033	CHIP CAP.	15pF	50V	CH	GRM39CH150J50PT	K22174215	VERSION C	5-
C 1034	CHIP CAP.	15pF	50V	CH	GRM39CH150J50PT	K22174215		1-
C 1034	CHIP CAP.	15pF	50V	CH	GRM39CH150J50PT	K22174215	VERSION C	5-
C 1034	CHIP CAP.	10pF	50V	CH	GRM39CH100D50PT	K22174211	VERSION A	5-
C 1035	CHIP CAP.	15pF	50V	CH	GRM39CH150J50PT	K22174215		1-

RF Unit

REF.	DESCRIPTION	VALUE	V/W	TOL.	MFGR'S DESIG	VXSTD P/N	VERS.	LOT.
C 1035	CHIP CAP.	10pF	50V	CH	GRM39CH100D50PT	K22174211	VERSION A	5-
C 1035	CHIP CAP.	15pF	50V	CH	GRM39CH150J50PT	K22174215	VERSION C	5-
C 1036	CHIP CAP.	0.001uF	50V	B	GRM39B102K50PT	K22174821		1-
C 1037	CHIP CAP.	12pF	50V	CH	GRM39CH120J50PT	K22174213		1-
C 1038	CHIP CAP.	18pF	50V	CH	GRM39CH180J50PT	K22174217		1-
C 1038	CHIP CAP.	9pF	50V	CH	GRM39CH090D50PT	K22174210	VERSION A	5-
C 1038	CHIP CAP.	18pF	50V	CH	GRM39CH180J50PT	K22174217	VERSION C	5-
C 1039	CHIP CAP.	15pF	50V	CH	GRM39CH150J50PT	K22174215		1-
C 1039	CHIP CAP.	15pF	50V	CH	GRM39CH150J50PT	K22174215	VERSION C	5-
C 1039	CHIP CAP.	10pF	50V	CH	GRM39CH100D50PT	K22174211	VERSION A	5-
C 1040	CHIP CAP.	0.1uF	16V	B	GRM39B104K16PT	K22124805		1-
C 1041	CHIP CAP.	0.001uF	50V	B	GRM39B102K50PT	K22174821		1-
C 1042	CHIP CAP.	0.01uF	50V	B	GRM39B103M50PT	K22174823		1-
C 1043	CHIP CAP.	15pF	50V	CH	GRM39CH150J50PT	K22174215		1-
C 1043	CHIP CAP.	22pF	50V	CH	GRM39CH220J50PT	K22174219	VERSION A	5-
C 1043	CHIP CAP.	15pF	50V	CH	GRM39CH150J50PT	K22174215	VERSION C	5-
C 1044	CHIP CAP.	15pF	50V	CH	GRM39CH150J50PT	K22174215		1-
C 1044	CHIP CAP.	10pF	50V	CH	GRM39CH100D50PT	K22174211	VERSION A	5-
C 1044	CHIP CAP.	15pF	50V	CH	GRM39CH150J50PT	K22174215	VERSION C	5-
C 1045	CHIP CAP.	220pF	50V	CH	GRM39CH221J50PT	K22174243		1-
C 1046	CHIP CAP.	22pF	50V	CH	GRM39CH220J50PT	K22174219		1-
C 1047	CHIP CAP.	0.001uF	50V	B	GRM39B102K50PT	K22174821		1-
C 1048	CHIP CAP.	0.01uF	50V	B	GRM39B103M50PT	K22174823		1-
C 1049	CHIP CAP.	15pF	50V	CH	GRM39CH150J50PT	K22174215		1-
C 1050	CHIP CAP.	15pF	50V	CH	GRM39CH150J50PT	K22174215		1-
C 1050	CHIP CAP.	39pF	50V	CH	GRM39CH390J50PT	K22174225	VERSION A	5-
C 1050	CHIP CAP.	15pF	50V	CH	GRM39CH150J50PT	K22174215	VERSION C	5-
C 1051	CHIP CAP.	56pF	50V	CH	GRM39CH560J50PT	K22174229		1-
C 1052	CHIP CAP.	0.1uF	16V	B	GRM39B104K16PT	K22124805		1-
C 1053	CHIP CAP.	0.1uF	16V	B	GRM39B104K16PT	K22124805		1-
C 1054	CHIP CAP.	220pF	50V	CH	GRM39CH221J50PT	K22174243		1-
C 1055	CHIP CAP.	0.1uF	16V	B	GRM39B104K16PT	K22124805		1-
C 1056	CHIP CAP.	0.001uF	50V	B	GRM39B102K50PT	K22174821		1-
C 1057	CHIP CAP.	0.01uF	50V	B	GRM39B103M50PT	K22174823		1-
C 1058	CHIP CAP.	0.01uF	50V	B	GRM40B103M50PT	K22170817		1-
C 1058	CHIP CAP.	0.01uF	50V	B	GRM39B103M50PT	K22174823		3-
C 1059	CHIP CAP.	0.001uF	50V	B	GRM39B102K50PT	K22174821		1-
C 1060	CHIP CAP.	0.001uF	50V	B	GRM39B102K50PT	K22174821		1-
C 1061	CHIP CAP.	0.001uF	50V	B	GRM39B102K50PT	K22174821		1-
C 1062	CHIP CAP.	100pF	50V	CH	GRM39CH101J50PT	K22174235		1-
C 1063	CHIP CAP.	0.001uF	50V	B	GRM39B102K50PT	K22174821		1-
C 1064	CHIP TA.CAP.	10uF	10V		TEMSVA1A106M-8R	K78100028		1-
C 1064	CHIP TA.CAP.	10uF	16V		TEMSVB21C106M-8R	K78120025		5-
C 1065	CHIP CAP.	0.001uF	50V	B	GRM39B102K50PT	K22174821		1-
C 1066	CHIP CAP.	0.001uF	50V	B	GRM39B102K50PT	K22174821		1-
C 1067	CHIP TA.CAP.	10uF	16V		TEMSVB21C106M-8R	K78120025		5-
C 1067	CHIP TA.CAP.	10uF	10V		TEMSVA1A106M-8R	K78100028		1-
C 1069	CHIP CAP.	9pF	50V	CH	GRM39CH090D50PT	K22174210	VERSION A	5-
C 1070	CHIP CAP.	10pF	50V	CH	GRM39CH100D50PT	K22174211	VERSION A	5-
C 1071	CHIP CAP.	10pF	50V	CH	GRM39CH100D50PT	K22174211	VERSION A	5-
C 1072	CHIP CAP.	15pF	50V	CH	GRM39CH150J50PT	K22174215		1-
C 1072	CHIP CAP.	15pF	50V	CH	GRM39CH150J50PT	K22174215	VERSION C	5-
C 1072	CHIP CAP.	39pF	50V	CH	GRM39CH390J50PT	K22174225	VERSION A	5-
C 1073	CHIP CAP.	0.001uF	50V	B	GRM39B102K50PT	K22174821		1-
C 1074	CHIP CAP.	100pF	50V	CH	GRM39CH101J50PT	K22174235		1-
C 1075	CHIP CAP.	0.001uF	500V	W5R	CF316W5R102K500AT	K22271802		1-
C 1075	CHIP CAP.	0.001uF	200V	SL	GRM42-6SL102J200PT	K22231104		13-
C 1076	CHIP CAP.	0.001uF	50V	B	GRM39B102K50PT	K22174821		1-
C 1077	CHIP CAP.	0.001uF	50V	B	GRM39B102K50PT	K22174821		1-
C 1078	CHIP CAP.	100pF	50V	CH	GRM39CH101J50PT	K22174235		1-

REF.	DESCRIPTION	VALUE	V/W	TOL.	MFGR'S DESIG	VXSTD P/N	VERS.	LOT.
C 1079	CHIP CAP.	0.001uF	50V	B	GRM39B102K50PT	K22174821		1-
C 1080	CHIP CAP.	10pF	50V	CH	GRM39CH100D50PT	K22174211	VERSION A	5-
C 1081	CHIP CAP.	470pF	50V	CH	GRM39CH471J50PT	K22174249		1-
C 1082	CHIP CAP.	330pF	50V	CH	GRM39CH331J50PT	K22174253		1-
C 1083	CHIP CAP.	100pF	50V	CH	GRM39CH101J50PT	K22174235		1-
C 1084	CHIP CAP.	0.001uF	50V	B	GRM39B102K50PT	K22174821		1-
C 1085	CHIP CAP.	9pF	50V	CH	GRM39CH090D50PT	K22174210		1-
C 1086	CHIP CAP.	0.001uF	50V	B	GRM39B102K50PT	K22174821		1-
C 1087	CHIP CAP.	0.001uF	50V	B	GRM39B102K50PT	K22174821		1-
C 1088	CHIP TA.CAP.	10uF	10V		TEMSVA1A106M-8R	K78100028		1-
C 1089	CHIP TA.CAP.	0.1uF	35V		TESVA1V104M1-8R	K78160025		1-
C 1090	CHIP CAP.	0.001uF	50V	B	GRM39B102K50PT	K22174821		1-
C 1092	CHIP TA.CAP.	1uF	16V		TESVA1C105M1-8R	K78120009		1-
C 1093	CHIP CAP.	68pF	50V	CH	GRM39CH680J50PT	K22174231		1-
C 1094	CHIP CAP.	0.001uF	200V	SL	GRM42-6SL102J200PT	K22231104		13-
C 1094	CHIP CAP.	0.001uF	500V	W5R	CF316W5R102K500AT	K22271802		1-
C 1095	CHIP CAP.	0.001uF	200V	SL	GRM42-6SL102J200PT	K22231104		13-
C 1095	CHIP CAP.	0.001uF	500V	W5R	CF316W5R102K500AT	K22271802		1-
C 1096	CHIP CAP.	120pF	500V	CH	GRM42-6CH121J500PT	K22271239		1-
C 1096	CHIP CAP.	150pF	300V	CG	ATC700B151KW300XT	K22253207	VERSION A	28-
C 1096	CHIP CAP.	120pF	300V	CG	C17CG121K3TXLT	K22253205	VERSION C	5-
C 1096	CHIP CAP.	150pF	300V	CG	C17CG151K3TXLT	K22253204	VERSION A	5-
C 1097	CHIP CAP.	33pF	50V	CH	GRM39CH330J50PT	K22174223		1-
C 1097	CHIP CAP.	27pF	50V	CH	GRM39CH270J50PT	K22174221	VERSION C	5-
C 1097	CHIP CAP.	33pF	50V	CH	GRM39CH330J50PT	K22174223	VERSION A	5-
C 1098	CHIP CAP.	0.001uF	50V	B	GRM39B102K50PT	K22174821		1-
C 1099	CHIP CAP.	18pF	50V	CH	GRM39CH180J50PT	K22174217		1-
C 1100	CHIP TA.CAP.	10uF	10V		TEMSVA1A106M-8R	K78100028		1-
C 1101	CHIP CAP.	0.001uF	50V	B	GRM39B102K50PT	K22174821		1-
C 1102	CHIP CAP.	2pF	50V	CK	GRM39CK020C50PT	K22174203		1-
C 1103	CHIP CAP.	47pF	50V	CH	GRM39CH470J50PT	K22174227		1-
C 1104	CHIP CAP.	15pF	500V	CH	GRM42-6CH150J500PT	K22271217		1-
C 1104	CHIP CAP.	27pF	500V	CG	C17CG270K4TXLT	K22273234	VERSION A	5-
C 1104	CHIP CAP.	22pF	500V	CG	C17CG220K4TXLT	K22273233	VERSION C	5-
C 1105	CERAMIC CAP.	39pF	500V	CH	GRH111CH390J500PT	K22273211		1-
C 1105	CHIP CAP.	39pF	500V	CG	C17CG390K4TXLT	K22273236		2-
C 1106	CHIP CAP.	1pF	50V	CK	GRM39CK010C50PT	K22174202		1-
C 1107	CHIP CAP.	18pF	500V	CH	GRM42-6CH180J500PT	K22271219		1-
C 1107	CHIP CAP.	33pF	500V	CG	C17CG330K4TXLT	K22273235	VERSION A	5-
C 1107	CHIP CAP.	22pF	500V	CG	C17CG220K4TXLT	K22273233	VERSION C	5-
C 1108	CHIP CAP.	22pF	500V	CH	GRM42-6CH220J500PT	K22271221		1-
C 1108	CHIP CAP.	27pF	500V	CG	C17CG270K4TXLT	K22273234	VERSION C	5-
C 1108	CHIP CAP.	39pF	500V	CG	C17CG390K4TXLT	K22273236	VERSION A	5-
C 1109	CHIP CAP.	1pF	50V	CK	GRM39CK010C50PT	K22174202		1-
C 1110	CHIP CAP.	33pF	500V	CH	CF316CH330J500AT	K22271261		1-
C 1110	CHIP CAP.	27pF	500V	CG	C17CG270K4TXLT	K22273234	VERSION C	5-
C 1110	CHIP CAP.	47pF	500V	CG	C17CG470K4TXLT	K22273219	VERSION A	5-
C 1111	CHIP CAP.	82pF	500V	CG	C17CG820K4TXLT	K22273221		1-
C 1112	CHIP CAP.	150pF	300V	CG	C17CG151K3TXLT	K22253204		1-
C 1112	CHIP CAP.	150pF	300V	CG	ATC700B151KW300XT	K22253207		28-
C 1113	CHIP CAP.	150pF	300V	CG	ATC700B151KW300XT	K22253207		28-
C 1113	CHIP CAP.	150pF	300V	CG	C17CG151K3TXLT	K22253204		1-
C 1114	CHIP CAP.	220pF	200V	CG	C17CG221K6TXLT	K22233211		1-
C 1114	CHIP CAP.	220pF	200V	CG	ATC700B221KW200XT	K22233217	VERSION C	31-
C 1114	CHIP CAP.	220pF	200V	CG	C17CG221K6TXLT	K22233211	VERSION C	5-
C 1114	CHIP CAP.	270pF	200V	CG	C17CG271K6TXLT	K22233212	VERSION A	5-
C 1115	CHIP CAP.	220pF	200V	CG	C17CG221K6TXLT	K22233211		1-
C 1115	CHIP CAP.	220pF	200V	CG	ATC700B221KW200XT	K22233217	VERSION C	31-
C 1115	CHIP CAP.	220pF	200V	CG	C17CG221K6TXLT	K22233211	VERSION C	5-
C 1115	CHIP CAP.	270pF	200V	CG	C17CG271K6TXLT	K22233212	VERSION A	5-

RF Unit

REF.	DESCRIPTION	VALUE	V/W	TOL.	MFGR'S DESIG	VXSTD P/N	VERS.	LOT.
C 1116	CHIP CAP.	56pF	50V	CH	GRM39CH560J50PT	K22174229		1-
C 1116	CHIP CAP.	100pF	50V	CH	GRM39CH101J50PT	K22174235	VERSION A	5-
C 1116	CHIP CAP.	68pF	50V	CH	GRM39CH680J50PT	K22174231	VERSION C	5-
C 1117	CHIP CAP.	5pF	50V	CH	GRM39CH050C50PT	K22174206		1-
C 1118	CHIP CAP.	18pF	50V	CH	GRM39CH180J50PT	K22174217		1-
C 1119	CHIP CAP.	10pF	50V	CH	GRM39CH100D50PT	K22174211		1-
C 1120	CHIP CAP.	0.01uF	50V	B	GRM39B103M50PT	K22174823		1-
C 1121	CHIP CAP.	100pF	50V	CH	GRM39CH101J50PT	K22174235		1-
C 1122	CHIP CAP.	0.1uF	16V	B	GRM39B104K16PT	K22124805		1-
C 1123	CHIP CAP.	0.1uF	16V	B	GRM39B104K16PT	K22124805		1-
C 1124	CHIP CAP.	27pF	50V	CH	GRM39CH270J50PT	K22174221		1-
C 1124	CHIP CAP.	22pF	50V	CH	GRM39CH220J50PT	K22174219	VERSION A	5-
C 1124	CHIP CAP.	27pF	50V	CH	GRM39CH270J50PT	K22174221	VERSION C	5-
C 1125	CHIP CAP.	10pF	50V	CH	GRM39CH100D50PT	K22174211		1-
C 1126	CHIP CAP.	8pF	50V	CH	GRM39CH080D50PT	K22174209		1-
C 1127	CHIP CAP.	5pF	50V	CH	GRM39CH050C50PT	K22174206		1-
C 1127	CHIP CAP.	0.001uF	50V	B	GRM39B102K50PT	K22174821		5-
C 1128	CHIP TA.CAP.	10uF	10V		TEMSVA1A106M-8R	K78100028		1-
C 1129	CHIP TA.CAP.	10uF	16V		TEMSVB21C106M-8R	K78120025		5-
C 1129	AL.ELECTRO.CAP.	33uF	25V		EEVHA1E330P	K48140011		1-
C 1130	CHIP CAP.	0.001uF	50V	B	GRM39B102K50PT	K22174821		1-
C 1131	CHIP CAP.	0.001uF	50V	B	GRM39B102M50PT	K22174809		1-
C 1131	CHIP CAP.	0.001uF	50V	B	GRM39B102K50PT	K22174821		5-
C 1133	CHIP CAP.	0.01uF	50V	B	GRM39B103M50PT	K22174823		1-
C 1134	CHIP CAP.	0.001uF	50V	B	GRM39B102K50PT	K22174821		1-
C 1135	CHIP CAP.	0.1uF	16V	B	GRM39B104K16PT	K22124805		1-
C 1136	CHIP CAP.	22pF	500V	CG	C17CG220K4TXLT	K22273233		5-
C 1137	CHIP CAP.	0.001uF	50V	B	GRM39B102K50PT	K22174821		1-
C 1138	CHIP TA.CAP.	10uF	10V		TEMSVA1A106M-8R	K78100028		1-
C 1139	CHIP CAP.	0.001uF	50V	B	GRM39B102K50PT	K22174821		1-
C 1140	CHIP TA.CAP.	10uF	10V		TEMSVA1A106M-8R	K78100028		1-
C 1140	CHIP TA.CAP.	10uF	16V		TEMSVB21C106M-8R	K78120025		5-
C 1141	CHIP TA.CAP.	10uF	10V		TEMSVA1A106M-8R	K78100028		1-
C 1141	CHIP TA.CAP.	10uF	16V		TEMSVB21C106M-8R	K78120025		5-
C 1142	CHIP TA.CAP.	10uF	10V		TEMSVA1A106M-8R	K78100028		1-
C 1143	CHIP TA.CAP.	10uF	10V		TEMSVA1A106M-8R	K78100028		1-
C 1144	CHIP CAP.	0.001uF	50V	B	GRM39B102K50PT	K22174821		1-
C 1146	CHIP TA.CAP.	10uF	10V		TEMSVA1A106M-8R	K78100028		1-
C 1147	CHIP CAP.	0.01uF	50V	B	GRM39B103M50PT	K22174823		1-
C 1148	CHIP CAP.	0.01uF	50V	B	GRM39B103M50PT	K22174823		1-
C 1149	CHIP CAP.	0.01uF	50V	B	GRM39B103M50PT	K22174823		1-
C 1150	CHIP CAP.	0.01uF	50V	B	GRM39B103M50PT	K22174823		1-
C 1151	CHIP CAP.	0.01uF	50V	B	GRM39B103M50PT	K22174823		1-
C 1152	CHIP CAP.	0.01uF	50V	B	GRM39B103M50PT	K22174823		1-
C 1154	CHIP CAP.	0.1uF	16V	B	GRM39B104K16PT	K22124805		1-
C 1155	CHIP CAP.	2pF	50V	CK	GRM39CK020C50PT	K22174203		1-
C 1155	CHIP CAP.	3pF	50V	CJ	GRM39CJ030C50PT	K22174204	VERSION A	5-
C 1155	CHIP CAP.	2pF	50V	CK	GRM39CK020C50PT	K22174203	VERSION C	5-
C 1156	CHIP CAP.	10pF	50V	CH	GRM39CH100D50PT	K22174211		1-
C 1157	CHIP CAP.	0.001uF	50V	B	GRM39B102K50PT	K22174821		1-
C 1158	CHIP CAP.	15pF	50V	CH	GRM39CH150J50PT	K22174215		5-
C 1158	CHIP CAP.	0.01uF	50V	B	GRM39B103M50PT	K22174823		1-
C 1159	CHIP CAP.	33pF	50V	CH	GRM39CH330J50PT	K22174223		1-
C 1160	CHIP CAP.	1pF	50V	CK	GRM39CK010C50PT	K22174202		1-
C 1161	CHIP CAP.	10pF	50V	CH	GRM39CH100D50PT	K22174211		1-
C 1162	CHIP CAP.	0.01uF	50V	B	GRM40B103M50PT	K22170817		1-
C 1163	CHIP CAP.	100pF	50V	CH	GRM39CH101J50PT	K22174235		1-
C 1164	CHIP CAP.	15pF	50V	CH	GRM39CH150J50PT	K22174215		1-
C 1164	CHIP CAP.	15pF	50V	CH	GRM39CH150J50PT	K22174215	VERSION C	5-
C 1164	CHIP CAP.	10pF	50V	CH	GRM39CH100D50PT	K22174211	VERSION A	5-

REF.	DESCRIPTION	VALUE	V/W	TOL.	MFGR'S DESIG	VXSTD P/N	VERS.	LOT.
C 1165	CHIP CAP.	6pF	50V	CH	GRM39CH060D50PT	K22174207		4-
C 1165	CHIP CAP.	8pF	50V	CH	GRM39CH080D50PT	K22174209		1-
C 1165	CHIP CAP.	10pF	50V	CH	GRM39CH100D50PT	K22174211		5-
C 1166	CHIP CAP.	1uF	10V	B	GRM40B105K10PT	K22100802		1-
C 1167	CHIP CAP.	0.001uF	50V	B	GRM39B102K50PT	K22174821		1-
C 1168	CHIP CAP.	0.001uF	50V	B	GRM39B102K50PT	K22174821		1-
C 1169	CHIP CAP.	0.01uF	50V	B	GRM39B103M50PT	K22174823		1-
C 1170	CHIP CAP.	0.01uF	50V	B	GRM39B103M50PT	K22174823		1-
C 1171	CHIP TA.CAP.	10uF	16V		TEMSVB21C106M-8R	K78120025		5-
C 1171	CHIP TA.CAP.	10uF	10V		TEMSVA1A106M-8R	K78100028		1-
C 1172	CHIP CAP.	15pF	50V	CH	GRM39CH150J50PT	K22174215		1-
C 1173	CHIP TA.CAP.	10uF	10V		TEMSVA1A106M-8R	K78100028		1-
C 1174	CHIP CAP.	0.01uF	50V	B	GRM39B103M50PT	K22174823		1-
C 1175	CHIP CAP.	0.01uF	50V	B	GRM39B103M50PT	K22174823		1-
C 1176	CHIP CAP.	0.01uF	50V	B	GRM39B103M50PT	K22174823		1-
C 1177	CHIP CAP.	100pF	50V	CH	GRM39CH101J50PT	K22174235		1-
C 1178	CHIP CAP.	0.1uF	16V	B	GRM39B104K16PT	K22124805		1-
C 1179	CHIP CAP.	220pF	50V	CH	GRM39CH221J50PT	K22174243		1-
C 1180	CHIP CAP.	0.01uF	50V	B	GRM39B103M50PT	K22174823		1-
C 1181	AL.ELECTRO.CAP.	2200uF	25V		RE3-25V222M	K40149055		1-
C 1182	CHIP CAP.	22pF	50V	CH	GRM39CH220J50PT	K22174219		1-
C 1183	AL.ELECTRO.CAP.	33uF	25V		EEVHA1E330P	K48140011		5-
C 1183	AL.ELECTRO.CAP.	100uF	25V		RE2-25V101M 100UF	K40149028		1-
C 1184	CHIP CAP.	0.0015uF	50V	B	GRM39B152M50PT	K22174811		1-
C 1185	CHIP CAP.	390pF	50V	CH	GRM39CH391J50PT	K22174255		1-
C 1186	CHIP CAP.	0.1uF	16V	B	GRM39B104K16PT	K22124805		1-
C 1187	CHIP CAP.	0.01uF	50V	B	GRM39B103M50PT	K22174823		1-
C 1188	CHIP CAP.	0.1uF	25V	B	GRM40B104M25PT	K22140811		1-
C 1189	CHIP CAP.	220pF	50V	CH	GRM39CH221J50PT	K22174243		1-
C 1190	CHIP CAP.	0.1uF	16V	B	GRM39B104K16PT	K22124805		1-
C 1191	AL.ELECTRO.CAP.	10uF	16V		ECEV1CS100SR	K48120001		1-
C 1191	CHIP TA.CAP.	10uF	16V		TEMSVB21C106M-8R	K78120025		5-
C 1192	AL.ELECTRO.CAP.	33uF	25V		EEVHA1E330P	K48140011		1-
C 1193	CHIP CAP.	100pF	50V	CH	GRM39CH101J50PT	K22174235		1-
C 1194	CHIP CAP.	0.01uF	50V	B	GRM39B103M50PT	K22174823		1-
C 1195	CHIP CAP.	100pF	50V	CH	GRM39CH101J50PT	K22174235		1-
C 1196	CHIP CAP.	0.1uF	25V	B	GRM40B104M25PT	K22140811		1-
C 1197	CHIP TA.CAP.	10uF	10V		TEMSVA1A106M-8R	K78100028		1-
C 1198	CHIP TA.CAP.	10uF	10V		TEMSVA1A106M-8R	K78100028		1-
C 1199	CHIP CAP.	0.1uF	16V	B	GRM39B104K16PT	K22124805		1-
C 1200	CHIP CAP.	100pF	50V	CH	GRM39CH101J50PT	K22174235		1-
C 1201	CHIP CAP.	100pF	50V	CH	GRM39CH101J50PT	K22174235		1-
C 1202	CHIP CAP.	0.1uF	16V	B	GRM39B104K16PT	K22124805		1-
C 1203	CHIP CAP.	0.1uF	16V	B	GRM39B104K16PT	K22124805		1-
C 1204	CHIP CAP.	0.1uF	16V	B	GRM39B104K16PT	K22124805		1-
C 1205	CHIP TA.CAP.	4.7uF	6.3V		TEMSVA0J475M-8R	K78080017		1-
C 1206	CHIP CAP.	100pF	50V	CH	GRM39CH101J50PT	K22174235		1-
C 1207	CHIP CAP.	10pF	50V	CH	GRM39CH100D50PT	K22174211		1-
C 1208	CHIP CAP.	10pF	50V	CH	GRM39CH100D50PT	K22174211		1-
C 1209	CHIP CAP.	10pF	50V	CH	GRM39CH100D50PT	K22174211		1-
C 1210	CHIP CAP.	10pF	50V	CH	GRM39CH100D50PT	K22174211		1-
C 1211	CHIP CAP.	100pF	50V	CH	GRM39CH101J50PT	K22174235		1-
C 1213	CHIP CAP.	0.1uF	16V	B	GRM39B104K16PT	K22124805		1-
C 1214	CHIP CAP.	0.001uF	50V	B	GRM39B102K50PT	K22174821		1-
C 1215	CHIP CAP.	0.1uF	16V	B	GRM39B104K16PT	K22124805		1-
C 1216	CHIP CAP.	100pF	50V	CH	GRM39CH101J50PT	K22174235		3-
C 1216	CERAMIC CAP.	100pF	50V	SL	DD105SL101J50	K00175101		1-
C 1217	CHIP CAP.	0.1uF	16V	B	GRM39B104K16PT	K22124805		1-
C 1218	CHIP CAP.	0.1uF	16V	B	GRM39B104K16PT	K22124805		1-
C 1219	CHIP TA.CAP.	4.7uF	6.3V		TEMSVA0J475M-8R	K78080017		5-

REF.	DESCRIPTION	VALUE	V/W	TOL.	MFGR'S DESIG	VXSTD P/N	VERS.	LOT.
C 1219	CHIP TA.CAP.	4.7uF	6.3V		TMCMA0J475MTR	K78080026		1-
C 1220	CHIP CAP.	100pF	50V	CH	GRM39CH101J50PT	K22174235		1-
C 1221	CHIP CAP.	100pF	50V	CH	GRM39CH101J50PT	K22174235		1-
C 1222	CHIP CAP.	100pF	50V	CH	GRM39CH101J50PT	K22174235		1-
C 1223	CHIP CAP.	0.1uF	16V	B	GRM39B104K16PT	K22124805		1-
C 1224	CHIP CAP.	0.01uF	50V	B	GRM39B103M50PT	K22174823		1-
C 1225	CHIP CAP.	100pF	50V	CH	GRM39CH101J50PT	K22174235		1-
C 1226	CHIP CAP.	100pF	50V	CH	GRM39CH101J50PT	K22174235		1-
C 1227	CHIP CAP.	100pF	50V	CH	GRM39CH101J50PT	K22174235		1-
C 1228	CHIP CAP.	100pF	50V	CH	GRM39CH101J50PT	K22174235		1-
C 1229	CHIP CAP.	0.01uF	50V	B	GRM39B103M50PT	K22174823		1-
C 1230	CHIP TA.CAP.	10uF	10V		TEMSVA1A106M-8R	K78100028		1-
C 1231	CHIP CAP.	0.1uF	16V	B	GRM39B104K16PT	K22124805		1-
C 1232	CHIP CAP.	0.01uF	50V	B	GRM39B103M50PT	K22174823		1-
C 1233	CERAMIC CAP.	100pF	50V	SL	DD105SL101J50	K00175101		1-
C 1233	CHIP CAP.	100pF	50V	CH	GRM39CH101J50PT	K22174235		3-
C 1234	CHIP TA.CAP.	10uF	10V		TEMSVA1A106M-8R	K78100028		1-
C 1234	CHIP TA.CAP.	10uF	16V		TEMSVB21C106M-8R	K78120025		5-
C 1235	CHIP CAP.	22pF	50V	CH	GRM39CH220J50PT	K22174219		1-
C 1236	CHIP CAP.	22pF	50V	CH	GRM39CH220J50PT	K22174219		1-
C 1237	CHIP CAP.	100pF	50V	CH	GRM39CH101J50PT	K22174235		1-
C 1238	CHIP CAP.	100pF	50V	CH	GRM39CH101J50PT	K22174235		1-
C 1239	CHIP CAP.	100pF	50V	CH	GRM39CH101J50PT	K22174235		1-
C 1240	CHIP CAP.	12pF	50V	CH	GRM39CH120J50PT	K22174213		1-
C 1241	CHIP CAP.	12pF	50V	CH	GRM39CH120J50PT	K22174213		1-
C 1242	CHIP CAP.	0.1uF	16V	B	GRM39B104K16PT	K22124805		5-
C 1242	CHIP CAP.	1uF	10V	B	GRM40B105K10PT	K22100802		1-
C 1243	CHIP CAP.	0.01uF	50V	B	GRM39B103M50PT	K22174823		1-
C 1244	CHIP CAP.	100pF	50V	CH	GRM39CH101J50PT	K22174235		1-
C 1245	CHIP CAP.	0.01uF	50V	B	GRM39B103M50PT	K22174823		1-
C 1246	CHIP CAP.	0.001uF	50V	B	GRM39B102K50PT	K22174821		1-
C 1247	CHIP CAP.	0.001uF	50V	B	GRM39B102K50PT	K22174821		1-
C 1248	CHIP CAP.	0.001uF	50V	B	GRM39B102K50PT	K22174821		1-
C 1249	CHIP CAP.	0.01uF	50V	B	GRM39B103M50PT	K22174823		1-
C 1250	CHIP CAP.	0.001uF	50V	B	GRM39B102K50PT	K22174821		1-
C 1251	CHIP CAP.	0.01uF	50V	B	GRM39B103M50PT	K22174823		1-
C 1252	CHIP CAP.	0.001uF	50V	B	GRM39B102K50PT	K22174821		1-
C 1253	CHIP CAP.	0.01uF	50V	B	GRM39B103M50PT	K22174823		1-
C 1254	CHIP CAP.	0.01uF	50V	B	GRM39B103M50PT	K22174823		1-
C 1255	CHIP CAP.	4pF	50V	CH	GRM39CH040C50PT	K22174205		1-
C 1255	CHIP CAP.	4pF	50V	CH	GRM39CH040C50PT	K22174205	VERSION C	5-
C 1255	CHIP CAP.	6pF	50V	CH	GRM39CH060D50PT	K22174207	VERSION A	5-
C 1256	CHIP TA.CAP.	2.2uF	10V		TESVA1A225M1-8R	K78100021		1-
C 1257	CHIP CAP.	33pF	50V	CH	GRM39CH330J50PT	K22174223		1-
C 1258	CHIP CAP.	0.1uF	16V	B	GRM39B104K16PT	K22124805		1-
C 1259	CHIP TA.CAP.	1uF	16V		TESVA1C105M1-8R	K78120009		1-
C 1260	CHIP CAP.	0.1uF	16V	B	GRM39B104K16PT	K22124805		1-
C 1261	CHIP CAP.	1uF	16V	B	GRM42-6B105K16NPT	K22121803		1-
C 1262	CHIP CAP.	0.1uF	16V	B	GRM39B104K16PT	K22124805		5-
C 1263	CHIP CAP.	0.1uF	16V	B	GRM39B104K16PT	K22124805		5-
C 1264	CERAMIC CAP.	100pF	50V	SL	DD105SL101J50	K00175101		1-
C 1264	CHIP CAP.	100pF	50V	CH	GRM39CH101J50PT	K22174235		5-
C 1266	CHIP CAP.	1uF	10V	B	GRM40B105K10PT	K22100802		1-
C 1267	CHIP CAP.	47pF	50V	CH	GRM39CH470J50PT	K22174227		1-
C 1268	CHIP CAP.	10pF	500V	CH	GRM42-6CH100D500PT	K22271213		1-
C 1269	CHIP CAP.	15pF	500V	CH	GRM42-6CH150J500PT	K22271217		1-
C 1270	CHIP CAP.	18pF	500V	CH	GRM42-6CH180J500PT	K22271219		1-
C 1271	CHIP CAP.	0.001uF	500V	W5R	CF316W5R102K500AT	K22271802		1-
C 1272	CHIP CAP.	15pF	50V	CH	GRM39CH150J50PT	K22174215	VERSION A	5-
C 1273	CHIP CAP.	33pF	500V	CH	CF316CH330J500AT	K22271261		1-

REF.	DESCRIPTION	VALUE	V/W	TOL.	MFGR'S DESIG	VXSTD P/N	VERS.	LOT.
C 1273	CHIP CAP.	33pF	500V	CH	CF316CH330J500AT	K22271261	VERSION C	5-
C 1273	CHIP CAP.	56pF	500V	CH	CF316CH560J500AT	K22271264	VERSION A	5-
C 1274	CHIP CAP.	33pF	500V	CH	CF316CH330J500AT	K22271261		1-
C 1274	CHIP CAP.	33pF	500V	CH	CF316CH330J500AT	K22271261	VERSION C	5-
C 1274	CHIP CAP.	56pF	500V	CH	CF316CH560J500AT	K22271264	VERSION A	5-
C 1275	CHIP CAP.	0.1uF	25V	B	GRM40B104M25PT	K22140811		1-
C 1276	CHIP CAP.	0.1uF	25V	B	GRM40B104M25PT	K22140811		1-
C 1277	CHIP CAP.	0.1uF	16V	B	GRM39B104K16PT	K22124805		5-
C 1278	CHIP CAP.	0.1uF	16V	B	GRM39B104K16PT	K22124805		5-
C 1279	CHIP CAP.	10pF	50V	CH	GRM39CH100D50PT	K22174211	VERSION A	5-
C 1280	CHIP CAP.	0.1uF	16V	B	GRM39B104K16PT	K22124805		5-
C 1282	CHIP TA.CAP.	10uF	10V		TEMSVA1A106M-8R	K78100028		5-
C 1282	CHIP CAP.	4.7uF	10V	BJ	LMK316BJ475ML-T	K22101802		13-
C 1283	AL.ELECTRO.CAP.	1000uF	25V		RE3-25V102M 1000UF	K40149045		5-
C 1284	CHIP CAP.	4.7uF	10V	BJ	LMK316BJ475ML-T	K22101802		13-
CD1001	CERAMIC DISC				CDBC455CX24-TC	H7900980		1-
CF1001	CERAMIC FILTER				PBFS455P9DR	H3900500		1-
CF1002	CERAMIC FILTER				PBFS455P12DR	H3900501		1-
D 1001	DIODE				MA143-(TX)	G2070536		1-
D 1002	DIODE				MA143-(TX)	G2070536		1-
D 1003	DIODE				MA143-(TX)	G2070536		1-
D 1004	DIODE				HVU350TRF	G2070380		1-
D 1005	DIODE				HVU350TRF	G2070380		1-
D 1006	DIODE				MA142WK-(TX)	G2070534		1-
D 1007	DIODE				MA142WK-(TX)	G2070534		1-
D 1008	DIODE				HVU350TRF	G2070380		1-
D 1009	DIODE				HVU350TRF	G2070380		1-
D 1010	DIODE				1SS353 TE-17	G2070394		1-
D 1010	DIODE				1SS355 TE-17	G2070470		3-
D 1013	DIODE				UM9957F/TR	G2070562		1-
D 1014	DIODE				1SS353 TE-17	G2070394		1-
D 1014	DIODE				1SS355 TE-17	G2070470		3-
D 1015	DIODE				1SS355 TE-17	G2070470		3-
D 1015	DIODE				1SS353 TE-17	G2070394		1-
D 1016	DIODE				UM9957F/TR	G2070562		5-
D 1017	DIODE				MA142WK-(TX)	G2070534		1-
D 1018	DIODE				UM9957F/TR	G2070562		5-
D 1019	DIODE				RD6.8UMB2-T1B	G2070438		1-
D 1020	DIODE				HVU350TRF	G2070380		1-
D 1021	DIODE				HVU350TRF	G2070380		1-
D 1022	DIODE				HVU350TRF	G2070380		1-
D 1023	DIODE				HVU350TRF	G2070380		1-
D 1024	DIODE				1SS319 TE85R	G2070080		1-
D 1025	DIODE				1SS353 TE-17	G2070394		1-
D 1025	DIODE				1SS355 TE-17	G2070470		3-
D 1026	DIODE				1T363-01-T8A	G2070114		1-
D 1027	DIODE				1T363-01-T8A	G2070114		1-
D 1028	DIODE				HVU350TRF	G2070380		1-
D 1031	DIODE				HVU350TRF	G2070380		1-
D 1032	DIODE				HVU350TRF	G2070380		1-
D 1033	DIODE				MA143-(TX)	G2070536		1-
D 1034	SURGE ABSORBER				P6KA18	Q9000721		5-
D 1034	SURGE ABSORBER				P6KE18	Q9000534		1-
D 1035	DIODE				MA143-(TX)	G2070536		1-
D 1036	DIODE				MA143-(TX)	G2070536		1-
D 1037	DIODE				MA143-(TX)	G2070536		1-
D 1038	DIODE				MA143-(TX)	G2070536		1-
D 1039	DIODE				MA143-(TX)	G2070536		1-
D 1040	DIODE				MA143-(TX)	G2070536		1-
D 1041	DIODE				MA143-(TX)	G2070536		1-

RF Unit

REF.	DESCRIPTION	VALUE	V/W	TOL.	MFGR'S DESIG	VXSTD P/N	VERS.	LOT.
D 1042	DIODE				MA143-(TX)	G2070536		1-
D 1043	DIODE				MA143-(TX)	G2070536		1-
D 1044	DIODE				MA143-(TX)	G2070536		1-
D 1045	DIODE				MA143-(TX)	G2070536		1-
D 1046	DIODE				MA143-(TX)	G2070536		1-
D 1047	DIODE				MA143-(TX)	G2070536		1-
D 1048	DIODE				MA143-(TX)	G2070536		1-
D 1049	DIODE				MA143-(TX)	G2070536		1-
D 1050	DIODE				MA143-(TX)	G2070536		1-
D 1051	DIODE				MA143-(TX)	G2070536		1-
D 1052	DIODE				02CZ5.1Y TE85R	G2070062		1-
D 1053	DIODE				1SS355 TE-17	G2070470		5-
D 1054	DIODE				1SS355 TE-17	G2070470		5-
D 1055	DIODE				RLS135 TE-11	G2070128	VERSION A	5-
D 1056	DIODE				MA143-(TX)	G2070536		5-
D 1057	DIODE				HZM5.6NB2 TR	G2070722		13-
F 1001	CHIP FUSE	0.25A			F0805B0R25FWTR	Q0000072		1-
F 1001	CHIP FUSE	0.25A			TF20N0.25TE	Q0000100		15-
FB1001	FERRITE BEADS				SMB304729	L9190094		1-
FB1002	FERRITE BEADS				SMB304729	L9190094		1-
FB1003	FERRITE BEADS				SMB304729	L9190094		1-
FB1004	FERRITE BEADS				SMB304729	L9190094		1-
FB1005	FERRITE BEADS				SMB304729	L9190094		1-
FB1006	FERRITE BEADS				SMB304729	L9190094		1-
J 1001	CONNECTOR				53398-0390	P0091192		1-
J 1002	CONNECTOR				53398-0290	P0091191		1-
J 1003	CONNECTOR				12FPZ-SM-TF	P1090996		1-
J 1004	CONNECTOR				53398-0990	P0091189		1-
J 1005	CONNECTOR				53398-0890	P0091194		1-
J 1006	CONNECTOR				53398-0790	P0091193		1-
J 1007	CONNECTOR				53398-0790	P0091193		1-
L 1001	CHIP COIL	1uH			C2520F-1R0K	L1690584		1-
L 1002	CHIP COIL	1uH			C2520F-1R0K	L1690584		1-
L 1003	CHIP COIL	0.82uH			C2520C-R82J	L1690555		1-
L 1004	CHIP COIL	0.12uH			C2520C-R12J	L1690545		1-
L 1004	CHIP COIL	0.1uH			C2520C-R10J	L1690544	VERSION C	5-
L 1004	CHIP COIL	0.12uH			C2520C-R12J	L1690545	VERSION A	5-
L 1005	CHIP COIL	0.12uH			C2520C-R12J	L1690545		1-
L 1005	CHIP COIL	0.1uH			C2520C-R10J	L1690544	VERSION C	5-
L 1005	CHIP COIL	0.12uH			C2520C-R12J	L1690545	VERSION A	5-
L 1006	CHIP COIL	0.12uH			C2520C-R12J	L1690545		1-
L 1006	CHIP COIL	0.1uH			C2520C-R10J	L1690544	VERSION C	5-
L 1006	CHIP COIL	0.12uH			C2520C-R12J	L1690545	VERSION A	5-
L 1007	CHIP COIL	0.22uH			C2520C-R22J	L1690548		1-
L 1008	CHIP COIL	0.027uH			C2520C-27NK	L1690537		1-
L 1008	CHIP COIL	0.027uH			C2520C-27NK	L1690537	VERSION C	5-
L 1008	CHIP COIL	0.047uH			C2520C-47NK	L1690540	VERSION A	5-
L 1009	COIL	0.047uH			AS0805-47NK	L0022539		7-
L 1009	COIL	0.047uH			AS0805-47NM	L0022484		1-
L 1010	COIL	0.056uH			AS0806-56NM	L0022485		1-
L 1010	COIL	0.056uH			AS0806-56NK	L0022540		7-
L 1011	M.RFC	0.082uH			LL2012*F82N	L1690346		1-
L 1012	COIL	0.056uH			AS0806-56NM	L0022485		1-
L 1012	COIL	0.056uH			AS0806-56NK	L0022540		7-
L 1013	COIL				E2 0.5-2.0-6T-R	L0022488		1-
L 1014	COIL				E2 0.5-2.0-6T-R	L0022488		1-
L 1015	COIL				E2 0.5-2.0-7T-R	L0022489		1-
L 1016	COIL	0.047uH			AS0805-47NK	L0022539		7-
L 1016	COIL	0.047uH			AS0805-47NM	L0022484		1-
L 1017	COIL	0.047uH			AS0805-47NM	L0022484		1-

REF.	DESCRIPTION	VALUE	V/W	TOL.	MFGR'S DESIG	VXSTD P/N	VERS.	LOT.
L 1017	COIL	0.047uH			AS0805-47NK	L0022539		7-
L 1018	COIL	0.047uH			AS0805-47NM	L0022484		5-
L 1018	COIL	0.047uH			AS0805-47NK	L0022539		7-
L 1018	COIL	0.033uH			AS0804-33NM	L0022483		1-
L 1019	COIL				E2 0.26-0.9-3T-R	L0022367		1-
L 1020	COIL				E2 0.45-1.4-4T-L	L0022391		1-
L 1021	CHIP COIL	0.22uH			C2520C-R22J	L1690548		1-
L 1022	CHIP COIL	0.22uH			C2520C-R22J	L1690548		1-
L 1023	CHIP COIL	0.047uH			C2520C-47NK	L1690540		1-
L 1024	M.RFC	0.22uH			LK2125 R22K-T	L1690311		1-
L 1025	COIL				E2 0.5-2.0-7T-R	L0022489		5-
L 1026	CHIP COIL	0.68uH			C2520C-R68J	L1690554		1-
L 1027	COIL				E2 0.3-1.7-8T-L	L0022376		1-
L 1027	COIL				E2 0.3-1.7-8T-L	L0022376	VERSION C	5-
L 1027	COIL				E2 0.25-1.9-8T-L	L0022550	VERSION A	5-
L 1028	CHIP COIL	0.22uH			C2520C-R22J	L1690548		1-
L 1029	COIL				E2 0.3-1.7-7T-R	L0022372		1-
L 1029	COIL				E2 0.3-1.7-8T-L	L0022376	VERSION A	5-
L 1029	COIL				E2 0.3-1.7-7T-R	L0022372	VERSION C	5-
L 1030	M.RFC	0.22uH			LK2125 R22K-T	L1690311		1-
L 1031	CHIP COIL	0.12uH			C2520C-R12J	L1690545		1-
L 1031	CHIP COIL	0.12uH			C2520C-R12J	L1690545	VERSION A	5-
L 1031	CHIP COIL	0.1uH			C2520C-R10J	L1690544	VERSION C	5-
L 1032	M.RFC	0.047uH			LL1608-F47NK	L1690367		1-
L 1033	M.RFC	0.047uH			LL1608-F47NK	L1690367		1-
L 1034	CHIP COIL	0.047uH			C2520C-47NK	L1690540	VERSION A	5-
L 1035	COIL	0.033uH			AS0804-33NM	L0022483		5-
L 1035	COIL	0.033uH			AS0804-33NK	L0022538		7-
L 1036	M.RFC	1uH			LK1608 1R0K-T	L1690687		5-
P 1001	TERMINAL				B4 AG M3	Q6000114		5-
Q 1001	TRANSISTOR				XN1213-(TX)	G3070194		1-
Q 1002	TRANSISTOR				2SA1586Y TE85R	G3115867Y		1-
Q 1004	FET				SGM2016AM-T7	G4070012		7-
Q 1004	FET				SGM2016M-T7	G4070005		1-
Q 1005	TRANSISTOR				2SC2620QBTR	G3326207B		1-
Q 1006	TRANSISTOR				2SC4116GR TE85R	G3341167G		1-
Q 1007	TRANSISTOR				2SC5226-4/5-TL	G3352268Z		1-
Q 1008	IC				BA4116FV-E2	G1092616		1-
Q 1009	TRANSISTOR				2SA1586Y TE85R	G3115867Y		1-
Q 1010	TRANSISTOR				UN5215-(TX)	G3070193		1-
Q 1012	TRANSISTOR				2SC4116GR TE85R	G3341167G		1-
Q 1013	TRANSISTOR				2SC5019-(TX)	G3350198		1-
Q 1014	TRANSISTOR				2SC2630	G3326300		1-
Q 1015	TRANSISTOR				2SC2539	G3325390		1-
Q 1016	TRANSISTOR				2SC4767	G3347670		1-
Q 1017	TRANSISTOR				2SC5226-4/5-TL	G3352268Z		1-
Q 1018	FET				2SK508-T2B K52	G3805087B		1-
Q 1019	IC				MB15A02PFV1-G-BND-EF	G1092541		1-
Q 1020	TRANSISTOR				2SB1201S-TL	G3070195		1-
Q 1021	TRANSISTOR				UN5213-(TX)	G3070192		1-
Q 1022	TRANSISTOR				2SB1122S-TD	G3211228S		5-
Q 1022	TRANSISTOR				2SB1132 T100 Q	G3211327Q		1-
Q 1023	TRANSISTOR				2SB1122S-TD	G3211228S		5-
Q 1023	TRANSISTOR				2SB1132 T100 Q	G3211327Q		1-
Q 1024	TRANSISTOR				2SB1122S-TD	G3211228S		5-
Q 1024	TRANSISTOR				2SB1132 T100 Q	G3211327Q		1-
Q 1025	FET				2SK508-T2B K52	G3805087B		1-
Q 1026	IC				TA75S01F TE85R	G1091593		1-
Q 1027	TRANSISTOR				2SC4116GR TE85R	G3341167G		1-
Q 1028	IC				S-8110AMP-DSB-T1	G1092937		13-

RF Unit

REF.	DESCRIPTION	VALUE	V/W	TOL.	MFGR'S DESIG	VXSTD P/N	VERS.	LOT.
Q 1028	IC				S-8100BF-SA-T1	G1092550		1-
Q 1029	IC				PST597CNR	G1092589		1-
Q 1030	TRANSISTOR				2SC4116GR TE85R	G3341167G		1-
Q 1031	IC				MM1216GNRE R59-2494	G1092431		1-
Q 1032	IC				MM1216GNRE R59-2494	G1092431		1-
Q 1033	TRANSISTOR				XN1213-(TX)	G3070194		1-
Q 1034	TRANSISTOR				UN5213-(TX)	G3070192		1-
Q 1035	TRANSISTOR				2SB1201S-TL	G3070195		1-
Q 1036	IC				AN7709	G1091753		1-
Q 1037	TRANSISTOR				XN1213-(TX)	G3070194		1-
Q 1038	TRANSISTOR				2SB1132 T100 Q	G3211327Q		1-
Q 1038	TRANSISTOR				2SB1122S-TD	G3211228S		5-
Q 1039	IC				MM1216GNRE R59-2494	G1092431		1-
Q 1040	TRANSISTOR				UN5213-(TX)	G3070192		1-
Q 1041	IC				TA75S01F TE85R	G1091593		1-
Q 1042	TRANSISTOR				2SB1134R	G3211340R		1-
Q 1043	IC				TDA1519A	G1092506		1-
Q 1044	IC				TC4S66F TE85R	G1090893		1-
Q 1045	IC				HD64F3337YF16(FLASH)	G1092971		17-
Q 1045	IC				HD64F3337YF16(FLASH)	G1092971		8-
Q 1045	IC				HD64F3334YF16(FLASH)	G1092077		1-
Q 1045	IC				DF3337YF16(FLASH)	G1093352		14-
Q 1046	TRANSISTOR				UN5213-(TX)	G3070192		1-
Q 1047	IC				SC11372CQ	G1092182		1-
Q 1047	IC				SC11372CQB1	G1092739		5-
Q 1048	TRANSISTOR				XN1213-(TX)	G3070194		1-
Q 1049	TRANSISTOR				UN5213-(TX)	G3070192		1-
Q 1050	TRANSISTOR				2SB1122S-TD	G3211228S		5-
Q 1050	TRANSISTOR				2SB1132 T100 Q	G3211327Q		1-
Q 1051	TRANSISTOR				UN5213-(TX)	G3070192		1-
Q 1052	IC				LC7385M-TE-R	G1092480		1-
Q 1053	IC				NM93C86AM8(TAPING)	G1092512		1-
Q 1055	TRANSISTOR				XN1213-(TX)	G3070194		1-
Q 1056	TRANSISTOR				2SC4116GR TE85R	G3341167G		1-
Q 1057	TRANSISTOR				XN1213-(TX)	G3070194		1-
Q 1058	IC				PST9145NR R59-2243	G1092479		1-
Q 1059	TRANSISTOR				UN5215-(TX)	G3070193		1-
Q 1060	TRANSISTOR				UN5215-(TX)	G3070193		1-
R 1001	CHIP RES.	560	1/16W	5%	RMC1/16 561JATP	J24185561		1-
R 1002	CHIP RES.	3.3k	1/16W	5%	RMC1/16 332JATP	J24185332		1-
R 1003	CHIP RES.	47	1/16W	5%	RMC1/16 470JATP	J24185470		1-
R 1004	CHIP RES.	2.2k	1/16W	5%	RMC1/16 222JATP	J24185222		1-
R 1005	CHIP RES.	100	1/16W	5%	RMC1/16 101JATP	J24185101		1-
R 1006	CHIP RES.	47k	1/16W	5%	RMC1/16 473JATP	J24185473		4-
R 1006	CHIP RES.	68k	1/16W	5%	RMC1/16 683JATP	J24185683		1-
R 1007	CHIP RES.	3.3k	1/16W	5%	RMC1/16 332JATP	J24185332		1-
R 1008	CHIP RES.	12k	1/16W	5%	RMC1/16 123JATP	J24185123		1-
R 1009	CHIP RES.	10k	1/16W	5%	RMC1/16 103JATP	J24185103		1-
R 1010	CHIP RES.	1k	1/16W	5%	RMC1/16 102JATP	J24185102		1-
R 1012	CHIP RES.	10k	1/16W	5%	RMC1/16 103JATP	J24185103		1-
R 1013	CHIP RES.	1k	1/16W	5%	RMC1/16 102JATP	J24185102		1-
R 1014	CHIP RES.	47k	1/16W	5%	RMC1/16 473JATP	J24185473		1-
R 1015	CHIP RES.	2.2k	1/16W	5%	RMC1/16 222JATP	J24185222		1-
R 1016	CHIP RES.	1k	1/16W	5%	RMC1/16 102JATP	J24185102		1-
R 1016	CHIP RES.	1k	1/16W	5%	RMC1/16 102JATP	J24185102	VERSION C	5-
R 1017	CHIP RES.	0	1/16W	5%	RMC1/16 000JATP	J24185000		1-
R 1018	CHIP RES.	220k	1/16W	5%	RMC1/16 224JATP	J24185224		1-
R 1019	CHIP RES.	10k	1/16W	5%	RMC1/16 103JATP	J24185103		1-
R 1020	CHIP RES.	47k	1/16W	5%	RMC1/16 473JATP	J24185473		1-
R 1021	CHIP RES.	47k	1/16W	5%	RMC1/16 473JATP	J24185473		1-

REF.	DESCRIPTION	VALUE	V/W	TOL.	MFGR'S DESIG	VXSTD P/N	VERS.	LOT.
R 1022	CHIP RES.	1k	1/16W	5%	RMC1/16 102JATP	J24185102		1-
R 1022	CHIP RES.	820	1/16W	5%	RMC1/16 821JATP	J24185821		5-
R 1023	CHIP RES.	1k	1/16W	5%	RMC1/16 102JATP	J24185102		1-
R 1024	CHIP RES.	0	1/16W	5%	RMC1/16 000JATP	J24185000		5-
R 1024	CHIP RES.	10	1/16W	5%	RMC1/16 100JATP	J24185100		1-
R 1025	CHIP RES.	47k	1/16W	5%	RMC1/16 473JATP	J24185473		1-
R 1026	CHIP RES.	47k	1/16W	5%	RMC1/16 473JATP	J24185473		1-
R 1027	CHIP RES.	1.8k	1/16W	5%	RMC1/16 182JATP	J24185182		1-
R 1028	CHIP RES.	390	1/16W	5%	RMC1/16 391JATP	J24185391		1-
R 1029	CHIP RES.	390	1/16W	5%	RMC1/16 391JATP	J24185391		1-
R 1029	CHIP RES.	47k	1/16W	5%	RMC1/16 473JATP	J24185473		5-
R 1030	CHIP RES.	220	1/16W	5%	RMC1/16 221JATP	J24185221		1-
R 1031	CHIP RES.	100k	1/16W	5%	RMC1/16 104JATP	J24185104		1-
R 1032	CHIP RES.	270	1/16W	5%	RMC1/16 271JATP	J24185271		1-
R 1032	CHIP RES.	220	1/16W	5%	RMC1/16 221JATP	J24185221		4-
R 1032	CHIP RES.	120	1/16W	5%	RMC1/16 121JATP	J24185121		5-
R 1033	CHIP RES.	33k	1/16W	5%	RMC1/16 333JATP	J24185333		1-
R 1034	CHIP RES.	220	1/16W	5%	RMC1/16 221JATP	J24185221		1-
R 1035	CHIP RES.	330k	1/16W	5%	RMC1/16 334JATP	J24185334		1-
R 1036	CHIP RES.	1.8k	1/16W	5%	RMC1/16 182JATP	J24185182		1-
R 1037	CHIP RES.	47k	1/16W	5%	RMC1/16 473JATP	J24185473		1-
R 1038	CHIP RES.	10k	1/16W	5%	RMC1/16 103JATP	J24185103		1-
R 1039	CHIP RES.	4.7k	1/16W	5%	RMC1/16 472JATP	J24185472		1-
R 1040	CHIP RES.	150	1W	5%	ERJ1WYJ151U	J24309017		1-
R 1040	CHIP RES.	100	1W	5%	ERJ1WYJ101U	J24309015		5-
R 1040	CHIP RES.	100	1W	5%	RMC1 101JTE	J24305101		16-
R 1041	CHIP RES.	330	1/16W	5%	RMC1/16 331JATP	J24185331		1-
R 1042	CHIP RES.	1k	1/16W	5%	RMC1/16 102JATP	J24185102		1-
R 1043	CHIP RES.	220	1W	5%	ERJ1WYJ221U	J24309019		1-
R 1043	CHIP RES.	220	1W	5%	RMC1 221JTE	J24305221		16-
R 1044	CHIP RES.	100	1/16W	5%	RMC1/16 101JATP	J24185101		5-
R 1044	CARBON FILM RES.	100	1/6W	5%	RD16PJ101 100	J01225101		1-
R 1045	CHIP RES.	1k	1/16W	5%	RMC1/16 102JATP	J24185102		1-
R 1046	CHIP RES.	4.7k	1/16W	5%	RMC1/16 472JATP	J24185472		1-
R 1047	CHIP RES.	0	1/16W	5%	RMC1/16 000JATP	J24185000		1-
R 1048	CHIP RES.	0	1/16W	5%	RMC1/16 000JATP	J24185000		1-
R 1049	CHIP RES.	220	1W	5%	ERJ1WYJ221U	J24309019		1-
R 1049	CHIP RES.	220	1W	5%	RMC1 221JTE	J24305221		16-
R 1050	CHIP RES.	100	1/16W	5%	RMC1/16 101JATP	J24185101		1-
R 1051	CHIP RES.	100	1/16W	5%	RMC1/16 101JATP	J24185101		1-
R 1052	CHIP RES.	2.2k	1/16W	5%	RMC1/16 222JATP	J24185222		1-
R 1053	CHIP RES.	100	1/16W	5%	RMC1/16 101JATP	J24185101		1-
R 1054	CHIP RES.	10k	1/16W	5%	RMC1/16 103JATP	J24185103		1-
R 1055	CHIP RES.	18	1/16W	5%	RMC1/16 180JATP	J24185180		1-
R 1056	CHIP RES.	3.3k	1/16W	5%	RMC1/16 332JATP	J24185332		1-
R 1057	CHIP RES.	2.2k	1/16W	5%	RMC1/16 222JATP	J24185222		1-
R 1058	CHIP RES.	18	1/16W	5%	RMC1/16 180JATP	J24185180		1-
R 1059	CHIP RES.	10	1/16W	5%	RMC1/16 100JATP	J24185100		1-
R 1060	CHIP RES.	3.3k	1/16W	5%	RMC1/16 332JATP	J24185332		1-
R 1061	CHIP RES.	560	1/16W	5%	RMC1/16 561JATP	J24185561		1-
R 1062	CHIP RES.	47k	1/16W	5%	RMC1/16 473JATP	J24185473		5-
R 1063	CHIP RES.	4.7k	1/16W	5%	RMC1/16 472JATP	J24185472		1-
R 1064	CHIP RES.	100k	1/16W	5%	RMC1/16 104JATP	J24185104		2-
R 1064	CHIP RES.	47k	1/16W	5%	RMC1/16 473JATP	J24185473		1-
R 1065	CHIP RES.	10k	1/16W	5%	RMC1/16 103JATP	J24185103		1-
R 1066	CHIP RES.	150	1/16W	5%	RMC1/16 151JATP	J24185151		1-
R 1067	METAL FILM RES.	10	2W	5%	ERG-2SJ100 10	J22335100		2-
R 1067	CHIP RES.	10	1/4W	5%	RMC1/4 100JATP	J24245100		1-
R 1067	CHIP RES.	10	1/16W	5%	RMC1/16 100JATP	J24185100		5-
R 1068	CHIP RES.	390	1/16W	5%	RMC1/16 391JATP	J24185391		1-

RF Unit

REF.	DESCRIPTION	VALUE	V/W	TOL.	MFGR'S DESIG	VXSTD P/N	VERS.	LOT.
R 1069	CHIP RES.	390	1/16W	5%	RMC1/16 391JATP	J24185391		1-
R 1070	CHIP RES.	4.7k	1/16W	5%	RMC1/16 472JATP	J24185472		1-
R 1071	CHIP RES.	1k	1/16W	5%	RMC1/16 102JATP	J24185102		1-
R 1072	CHIP RES.	4.7k	1/16W	5%	RMC1/16 472JATP	J24185472		1-
R 1072	CHIP RES.	10k	1/16W	5%	RMC1/16 103JATP	J24185103		5-
R 1073	CHIP RES.	2.2k	1/16W	5%	RMC1/16 222JATP	J24185222		1-
R 1074	CHIP RES.	33	1/16W	5%	RMC1/16 330JATP	J24185330		1-
R 1075	CHIP RES.	47	1/16W	5%	RMC1/16 470JATP	J24185470		1-
R 1076	CHIP RES.	10k	1/16W	5%	RMC1/16 103JATP	J24185103		1-
R 1077	CHIP RES.	1k	1/16W	5%	RMC1/16 102JATP	J24185102		1-
R 1077	CHIP RES.	10k	1/16W	5%	RMC1/16 103JATP	J24185103	VERSION C	5-
R 1077	CHIP RES.	2.2k	1/16W	5%	RMC1/16 222JATP	J24185222	VERSION A	5-
R 1078	CHIP RES.	150	1/16W	5%	RMC1/16 151JATP	J24185151		1-
R 1078	CHIP RES.	220	1/16W	5%	RMC1/16 221JATP	J24185221		3-
R 1079	CHIP RES.	10k	1/16W	5%	RMC1/16 103JATP	J24185103		1-
R 1079	CHIP RES.	8.2k	1/16W	5%	RMC1/16 822JATP	J24185822	VERSION A	5-
R 1079	CHIP RES.	6.8k	1/16W	5%	RMC1/16 682JATP	J24185682	VERSION C	5-
R 1080	CHIP RES.	100k	1/16W	5%	RMC1/16 104JATP	J24185104		1-
R 1081	CHIP RES.	100	1/16W	5%	RMC1/16 101JATP	J24185101		1-
R 1082	CHIP RES.	10k	1/16W	5%	RMC1/16 103JATP	J24185103		1-
R 1082	CHIP RES.	10k	1/16W	5%	RMC1/16 103JATP	J24185103	VERSION A	5-
R 1082	CHIP RES.	6.8k	1/16W	5%	RMC1/16 682JATP	J24185682	VERSION C	5-
R 1083	CHIP RES.	10k	1/16W	5%	RMC1/16 103JATP	J24185103		1-
R 1084	CHIP RES.	2.2k	1/16W	5%	RMC1/16 222JATP	J24185222		1-
R 1085	CHIP RES.	3.3k	1/16W	5%	RMC1/16 332JATP	J24185332		5-
R 1085	CHIP RES.	470	1/16W	5%	RMC1/16 471JATP	J24185471		1-
R 1086	CHIP RES.	82k	1/16W	5%	RMC1/16 823JATP	J24185823		1-
R 1087	CHIP RES.	2.2k	1/16W	5%	RMC1/16 222JATP	J24185222		1-
R 1088	CHIP RES.	47k	1/16W	5%	RMC1/16 473JATP	J24185473		1-
R 1089	CHIP RES.	47k	1/16W	5%	RMC1/16 473JATP	J24185473		1-
R 1090	CHIP RES.	0	1/16W	5%	RMC1/16 000JATP	J24185000		1-
R 1091	CHIP RES.	22k	1/16W	5%	RMC1/16 223JATP	J24185223		1-
R 1092	CHIP RES.	10k	1/16W	5%	RMC1/16 103JATP	J24185103		1-
R 1093	CHIP RES.	47k	1/16W	5%	RMC1/16 473JATP	J24185473		1-
R 1094	CHIP RES.	4.7k	1/16W	5%	RMC1/16 472JATP	J24185472		1-
R 1096	CHIP RES.	2.2k	1/16W	5%	RMC1/16 222JATP	J24185222		1-
R 1097	CHIP RES.	33	1/16W	5%	RMC1/16 330JATP	J24185330		1-
R 1098	CHIP RES.	1k	1/16W	5%	RMC1/16 102JATP	J24185102		1-
R 1099	CHIP RES.	33k	1/16W	5%	RMC1/16 333JATP	J24185333		1-
R 1100	CHIP RES.	10k	1/16W	5%	RMC1/16 103JATP	J24185103		1-
R 1101	CHIP RES.	1k	1/16W	5%	RMC1/16 102JATP	J24185102		1-
R 1102	CHIP RES.	10k	1/16W	5%	RMC1/16 103JATP	J24185103		1-
R 1103	CHIP RES.	2.2k	1/16W	5%	RMC1/16 222JATP	J24185222		1-
R 1104	CHIP RES.	220k	1/16W	5%	RMC1/16 224JATP	J24185224		1-
R 1105	CHIP RES.	100k	1/16W	5%	RMC1/16 104JATP	J24185104		1-
R 1106	CHIP RES.	1k	1/16W	5%	RMC1/16 102JATP	J24185102		1-
R 1107	CHIP RES.	33k	1/16W	5%	RMC1/16 333JATP	J24185333		1-
R 1108	CHIP RES.	220k	1/16W	5%	RMC1/16 224JATP	J24185224		1-
R 1109	CHIP RES.	100k	1/16W	5%	RMC1/16 104JATP	J24185104		1-
R 1110	CHIP RES.	2.2k	1/16W	5%	RMC1/16 222JATP	J24185222		1-
R 1111	CHIP RES.	1k	1/16W	5%	RMC1/16 102JATP	J24185102		1-
R 1112	CHIP RES.	1k	1/16W	5%	RMC1/16 102JATP	J24185102		1-
R 1113	CHIP RES.	47k	1/16W	5%	RMC1/16 473JATP	J24185473		1-
R 1114	CHIP RES.	100k	1/16W	5%	RMC1/16 104JATP	J24185104		1-
R 1115	CHIP RES.	220k	1/16W	5%	RMC1/16 224JATP	J24185224		1-
R 1116	CHIP RES.	220k	1/16W	5%	RMC1/16 224JATP	J24185224		1-
R 1117	CHIP RES.	220k	1/16W	5%	RMC1/16 224JATP	J24185224		1-
R 1118	CHIP RES.	10k	1/16W	5%	RMC1/16 103JATP	J24185103		1-
R 1119	CHIP RES.	10k	1/16W	5%	RMC1/16 103JATP	J24185103		1-
R 1120	CHIP RES.	10k	1/16W	5%	RMC1/16 103JATP	J24185103		1-

REF.	DESCRIPTION	VALUE	V/W	TOL.	MFGR'S DESIG	VXSTD P/N	VERS.	LOT.
R 1121	CHIP RES.	100k	1/16W	5%	RMC1/16 104JATP	J24185104		1-
R 1122	CHIP RES.	10k	1/16W	5%	RMC1/16 103JATP	J24185103		1-
R 1123	CHIP RES.	4.7k	1/16W	5%	RMC1/16 472JATP	J24185472		1-
R 1124	CHIP RES.	2.2k	1/16W	5%	RMC1/16 222JATP	J24185222		1-
R 1125	CHIP RES.	2.2k	1/16W	5%	RMC1/16 222JATP	J24185222		3-
R 1126	CHIP RES.	47k	1/16W	5%	RMC1/16 473JATP	J24185473		1-
R 1127	CHIP RES.	1k	1/16W	5%	RMC1/16 102JATP	J24185102		1-
R 1128	CHIP RES.	47k	1/16W	5%	RMC1/16 473JATP	J24185473		1-
R 1129	CHIP RES.	560	1/16W	5%	RMC1/16 561JATP	J24185561		1-
R 1130	CHIP RES.	1k	1/16W	5%	RMC1/16 102JATP	J24185102		1-
R 1131	CHIP RES.	330	1/16W	5%	RMC1/16 331JATP	J24185331		1-
R 1132	CHIP RES.	1k	1/16W	5%	RMC1/16 102JATP	J24185102		1-
R 1133	CHIP RES.	330	1/16W	5%	RMC1/16 331JATP	J24185331		1-
R 1134	CHIP RES.	330	1/16W	5%	RMC1/16 331JATP	J24185331		1-
R 1135	CHIP RES.	330	1/16W	5%	RMC1/16 331JATP	J24185331		1-
R 1136	CHIP RES.	5.6k	1/16W	5%	RMC1/16 562JATP	J24185562		1-
R 1137	CHIP RES.	5.6k	1/16W	5%	RMC1/16 562JATP	J24185562		1-
R 1138	CHIP RES.	330	1/16W	5%	RMC1/16 331JATP	J24185331		1-
R 1139	CHIP RES.	10k	1/16W	5%	RMC1/16 103JATP	J24185103		1-
R 1140	CHIP RES.	2.2k	1/16W	5%	RMC1/16 222JATP	J24185222		3-
R 1141	CHIP RES.	330	1/16W	5%	RMC1/16 331JATP	J24185331		1-
R 1142	CHIP RES.	2.2k	1/16W	5%	RMC1/16 222JATP	J24185222		1-
R 1143	CHIP RES.	2.2k	1/16W	5%	RMC1/16 222JATP	J24185222		1-
R 1144	CHIP RES.	2.2k	1/16W	5%	RMC1/16 222JATP	J24185222		1-
R 1145	CHIP RES.	1.2k	1/16W	5%	RMC1/16 122JATP	J24185122		1-
R 1146	CHIP RES.	2.7k	1/16W	5%	RMC1/16 272JATP	J24185272		1-
R 1147	CHIP RES.	5.6k	1/16W	5%	RMC1/16 562JATP	J24185562		1-
R 1148	CHIP RES.	100k	1/16W	5%	RMC1/16 104JATP	J24185104		1-
R 1149	CHIP RES.	100k	1/16W	5%	RMC1/16 104JATP	J24185104		1-
R 1150	CHIP RES.	0	1/16W	5%	RMC1/16 000JATP	J24185000		1-
R 1151	CHIP RES.	10k	1/16W	5%	RMC1/16 103JATP	J24185103		1-
R 1152	CHIP RES.	5.6k	1/16W	5%	RMC1/16 562JATP	J24185562		1-
R 1153	CHIP RES.	5.6k	1/16W	5%	RMC1/16 562JATP	J24185562		1-
R 1154	CHIP RES.	4.7k	1/16W	5%	RMC1/16 472JATP	J24185472		1-
R 1155	CHIP RES.	3.3k	1/16W	5%	RMC1/16 332JATP	J24185332		1-
R 1156	CHIP RES.	33k	1/16W	5%	RMC1/16 333JATP	J24185333		1-
R 1157	CHIP RES.	1k	1/16W	5%	RMC1/16 102JATP	J24185102		1-
R 1158	CHIP RES.	0	1/16W	5%	RMC1/16 000JATP	J24185000		1-
R 1159	CHIP RES.	33k	1/16W	5%	RMC1/16 333JATP	J24185333		1-
R 1160	CHIP RES.	0	1/16W	5%	RMC1/16 000JATP	J24185000		1-
R 1161	CHIP RES.	0	1/16W	5%	RMC1/16 000JATP	J24185000		1-
R 1162	CHIP RES.	1.2k	1/16W	5%	RMC1/16 122JATP	J24185122		1-
R 1163	CHIP RES.	47	1/16W	5%	RMC1/16 470JATP	J24185470		1-
R 1164	CHIP RES.	33k	1/16W	5%	RMC1/16 333JATP	J24185333		1-
R 1165	CHIP RES.	33k	1/16W	5%	RMC1/16 333JATP	J24185333		1-
R 1166	CHIP RES.	22k	1/16W	5%	RMC1/16 223JATP	J24185223		1-
R 1167	CHIP RES.	22k	1/16W	5%	RMC1/16 223JATP	J24185223		1-
R 1168	CHIP RES.	47k	1/16W	5%	RMC1/16 473JATP	J24185473		1-
R 1169	CHIP RES.	6.8k	1/16W	5%	RMC1/16 682JATP	J24185682		1-
R 1170	CHIP RES.	0	1/16W	5%	RMC1/16 000JATP	J24185000		1-
R 1171	CHIP RES.	47k	1/16W	5%	RMC1/16 473JATP	J24185473		1-
R 1172	CHIP RES.	5.6k	1/16W	5%	RMC1/16 562JATP	J24185562		1-
R 1173	CHIP RES.	4.7k	1/16W	5%	RMC1/16 472JATP	J24185472		1-
R 1174	CHIP RES.	47k	1/16W	5%	RMC1/16 473JATP	J24185473		1-
R 1175	CHIP RES.	47k	1/16W	5%	RMC1/16 473JATP	J24185473		1-
R 1176	CHIP RES.	47k	1/16W	5%	RMC1/16 473JATP	J24185473		1-
R 1177	CHIP RES.	47k	1/16W	5%	RMC1/16 473JATP	J24185473		1-
R 1178	CHIP RES.	47k	1/16W	5%	RMC1/16 473JATP	J24185473		1-
R 1179	CHIP RES.	47k	1/16W	5%	RMC1/16 473JATP	J24185473		1-
R 1180	CHIP RES.	47k	1/16W	5%	RMC1/16 473JATP	J24185473		1-

RF Unit

REF.	DESCRIPTION	VALUE	V/W	TOL.	MFGR'S DESIG	VXSTD P/N	VERS.	LOT.
R 1181	CHIP RES.	47k	1/16W	5%	RMC1/16 473JATP	J24185473		1-
R 1182	CHIP RES.	10k	1/16W	5%	RMC1/16 103JATP	J24185103		1-
R 1183	CHIP RES.	47k	1/16W	5%	RMC1/16 473JATP	J24185473		1-
R 1184	CHIP RES.	47k	1/16W	5%	RMC1/16 473JATP	J24185473		1-
R 1185	CHIP RES.	47k	1/16W	5%	RMC1/16 473JATP	J24185473		1-
R 1186	CHIP RES.	47k	1/10W	5%	RMC1/10T 473J	J24205473		1-
R 1186	CHIP RES.	47k	1/16W	5%	RMC1/16 473JATP	J24185473		3-
R 1187	CHIP RES.	10k	1/16W	5%	RMC1/16 103JATP	J24185103		1-
R 1189	METAL FILM RES.	10	3W	5%	ERG-3SJ100P 10	J22359031		3-
R 1189	METAL FILM RES.	18	2W	5%	ERG-2SJ180P 18	J22339004		1-
R 1190	CHIP RES.	47k	1/16W	5%	RMC1/16 473JATP	J24185473		1-
R 1191	CHIP RES.	47k	1/16W	5%	RMC1/16 473JATP	J24185473		1-
R 1192	CHIP RES.	0	1/16W	5%	RMC1/16 000JATP	J24185000		1-
R 1193	CHIP RES.	0	1/16W	5%	RMC1/16 000JATP	J24185000		1-
R 1194	CHIP RES.	22k	1/16W	5%	RMC1/16 223JATP	J24185223		1-
R 1195	CHIP RES.	0	1/16W	5%	RMC1/16 000JATP	J24185000		3-
R 1196	CHIP RES.	0	1/16W	5%	RMC1/16 000JATP	J24185000		3-
R 1197	CHIP RES.	0	1/16W	5%	RMC1/16 000JATP	J24185000		3-
R 1198	METAL FILM RES.	18	2W	5%	ERG-2SJ180P 18	J22339004		1-
R 1199	CHIP RES.	470	1/16W	5%	RMC1/16 471JATP	J24185471		1-
R 1201	CHIP RES.	330	1/16W	5%	RMC1/16 331JATP	J24185331		1-
R 1202	CARBON FILM RES.	10	1/4W	5%	RD14TPJ100	J07245100		1-
R 1202	CHIP RES.	10	1/4W	5%	RMC1/4 100JATP	J24245100		5-
R 1203	CHIP RES.	47	1/16W	5%	RMC1/16 470JATP	J24185470		1-
R 1203	CHIP RES.	0	1/16W	5%	RMC1/16 000JATP	J24185000	VERSION C	5-
R 1204	CHIP RES.	0	1/16W	5%	RMC1/16 000JATP	J24185000		5-
R 1205	CHIP RES.	0	1/16W	5%	RMC1/16 000JATP	J24185000		5-
R 1206	CHIP RES.	4.7k	1/16W	5%	RMC1/16 472JATP	J24185472		5-
R 1207	CHIP RES.	4.7k	1/16W	5%	RMC1/16 472JATP	J24185472		5-
R 1208	CHIP RES.	10k	1/16W	5%	RMC1/16 103JATP	J24185103		5-
R 1209	CHIP RES.	47k	1/16W	5%	RMC1/16 473JATP	J24185473		13-
R 1210	CHIP RES.	0	1/16W	5%	RMC1/16 000JATP	J24185000		13-
R 1211	CHIP RES.	10k	1/16W	5%	RMC1/16 103JATP	J24185103		13-
TC1002	TRIMMER CAP.	20pF			ECR-JA020E11X	K91000228		1-
TC1002	TRIMMER CAP.	10pF			ECR-JA010A11X	K91000227		5-
TH1001	THERMISTOR				NTCCM20123NH153JCT	G9090105		1-
TH1002	THERMISTOR				NTCCM20123SH223JCT	G9090106		1-
X 1001	XTAL LP-5.0S.2S	20.945MHz			20.945MHZ	H0103169		1-
X 1002	XTAL TOP-B	14.4MHz			14.4MHZ	H0103160		1-
X 1003	XTAL LP-5.0S.2S	11.0592MHz			11.0592MHZ	H0103165		1-
X 1004	CERAMIC OSC	3.58MHz			PBRC3.58AR03-LC6	H7901190		1-
XF1001	XTAL FILTER				21M10B1	H1102314		5-
XF1001	XTAL FILTER				21S102A	H1102298		1-
XF1002	XTAL FILTER				21M10B1	H1102314		5-
XF1002	XTAL FILTER				21S102A	H1102298		1-
	SHIELD CASE					RA0014300		1-
	SHIELD CASE					RA0014200		1-
	SHIELD CASE					RA0015000		1-
	SHIELD CASE					RA001500A		3-
	HEATSINK PLATE					RA0015300		1-
	LEAF SPRING					R0132100		5-

Circuit Diagram

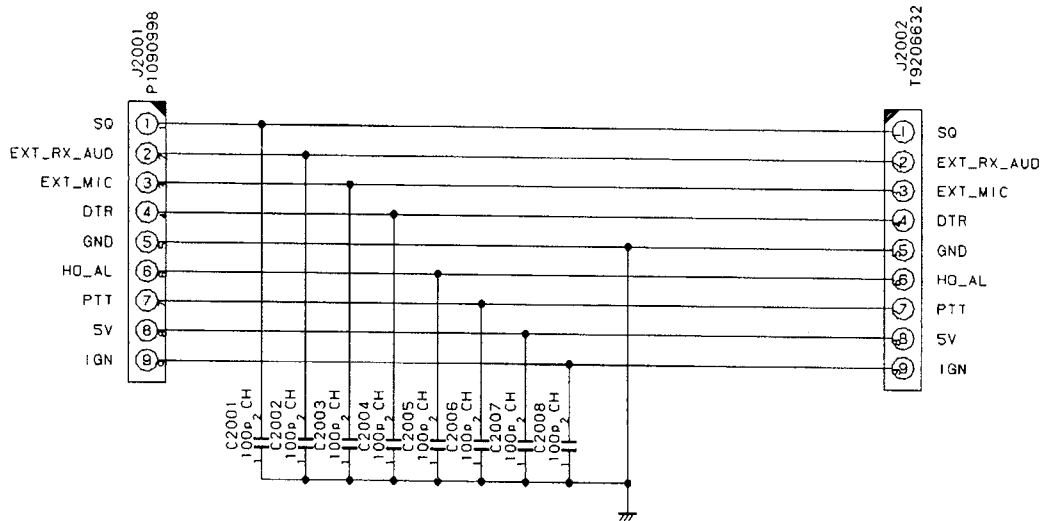

Parts Layout

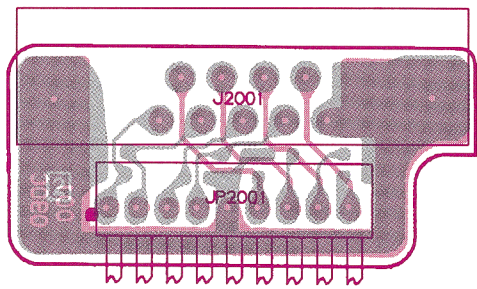

Component Side

To RF Unit
(See Page 4A-3)

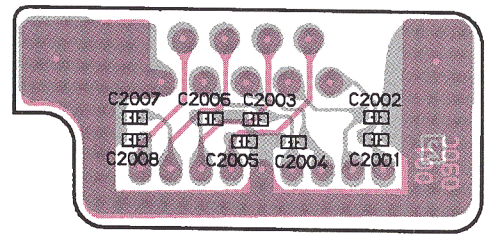

Solder Side

Parts List

REF.	DESCRIPTION	VALUE	V/W	TOL.	MFGR'S DESIG	VXSTD P/N	VERS.	LOT.
*** D-SUB UNIT ***								
PCB with Component						CB0169001		1-
Printed Circuit Board						FR001090C		1-
C 2001	CHIP CAP.	100pF	50V	CH	GRM39CH101J50PT	K22174235		1-
C 2002	CHIP CAP.	100pF	50V	CH	GRM39CH101J50PT	K22174235		1-
C 2003	CHIP CAP.	100pF	50V	CH	GRM39CH101J50PT	K22174235		1-
C 2004	CHIP CAP.	100pF	50V	CH	GRM39CH101J50PT	K22174235		1-
C 2005	CHIP CAP.	100pF	50V	CH	GRM39CH101J50PT	K22174235		1-
C 2006	CHIP CAP.	100pF	50V	CH	GRM39CH101J50PT	K22174235		1-
C 2007	CHIP CAP.	100pF	50V	CH	GRM39CH101J50PT	K22174235		1-
C 2008	CHIP CAP.	100pF	50V	CH	GRM39CH101J50PT	K22174235		1-
J 2001	CONNECTOR				AE0031-00	P1090998		1-
J 2002	WIRE ASSY				A0834+	T9206632		1-
	HOLDER					RA0014400		1-

DSUB Unit

Notes:

Front-AUnit

Notes:

Parts Layout

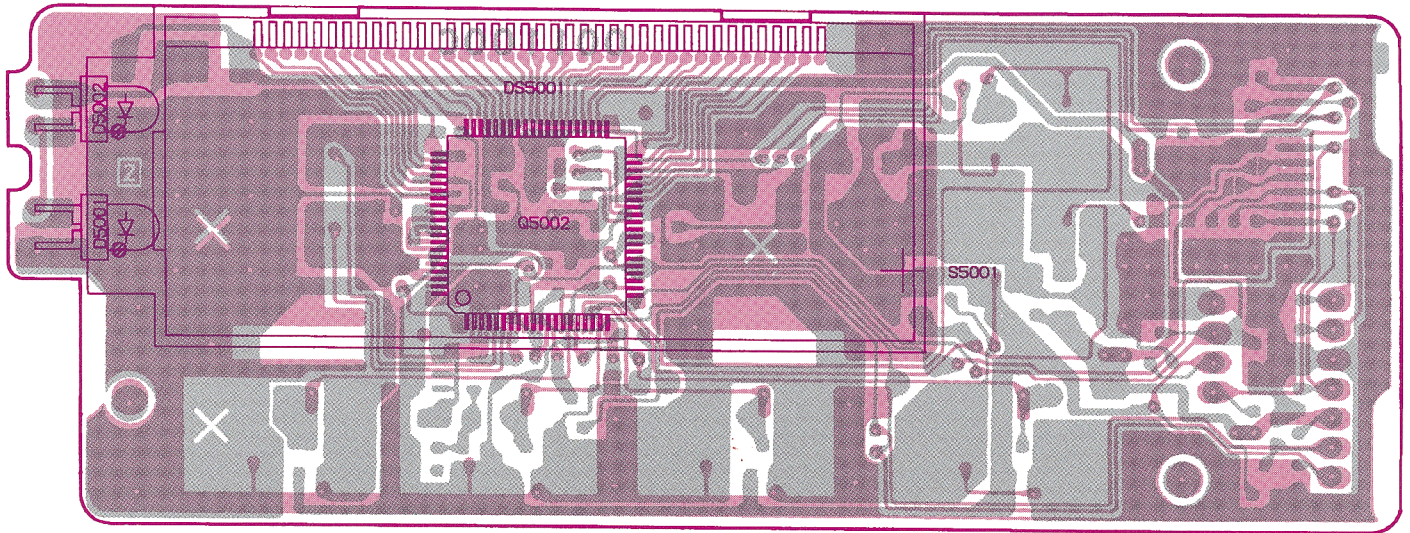

LCD Side

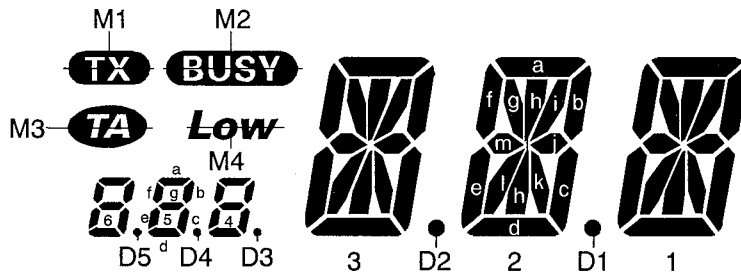
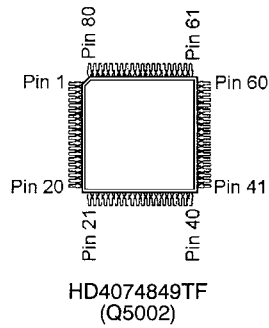

Pin No.	1	2	3	4	5	6	7	8	9	10	11	12	13	14	15	16	17	18	19	20
		COM1		D5	6d	6e	6f	6a	5a	5f	5e	5d	M2	4a	4f	4e	4d	3e	3f	3a
	COM2		D3		6c	6g	6b	M3	M1	5b	5g	5c	M4	D4	4b	4g	4c	3l	3m	3g
Pin No.	21	22	23	24	25	26	27	28	29	30	31	32	33	34	35	36	37	38	39	
	3b	3c		3d	D2	2c	2d	2e	2f	2a	2b	2j	1f	1a	1b	1c	1d	1e		
	3i	3j	3k	3h		2k	2h	2l	2m	2g	2i	1m	1g	1i	1j	1k	1h	1l	D1	

DS5001 LCD Display

Front-A Unit

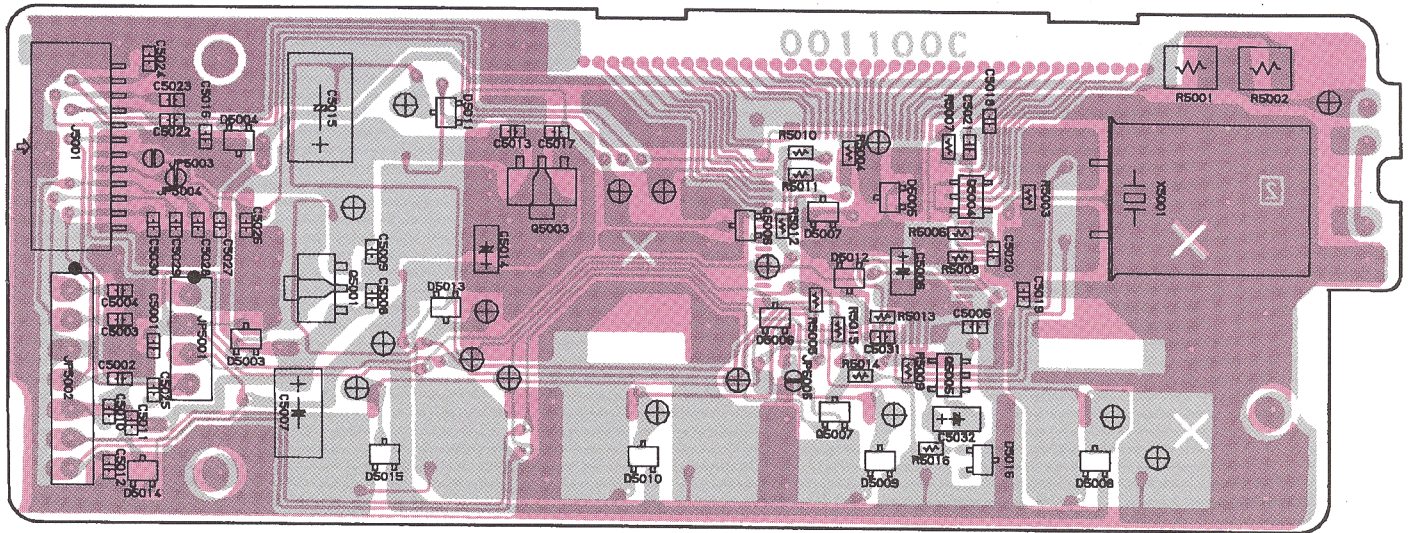

Component Side

J5001

- GND
- CLK_FD
- BUSY
- FD
- 13SWD
- D_ON
- MUTE
- VOL
- HOOK
- PTT
- MIC
- GND

To RF Unit J1003
(See Page 4A-3)

JP5002

- PTT
- HOOK
- GND
- MIC
- 9V
- CL_SW
- CL_DATA

To MIC Unit JP7101
(See Page 4F-1)



NJM78L09UA (8H)
(Q5001)

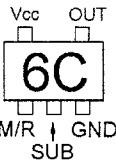

PST596CNR (6C)
(Q 5005)



NJM78L05UA (8C)
(Q5003)

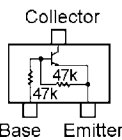

UN5213-(TX) (8C)
(Q5006, 5007)

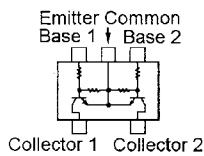

XN1213-(TX) (9L)
(Q5004)

Cathode 1, Anode 2

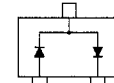

MA143-(TX) (MC)
(D5003, 5004, 5005, 5006, 5007,
5008, 5009, 5010, 5011, 5012,
5013, 5014, 5015)

Circuit Diagram

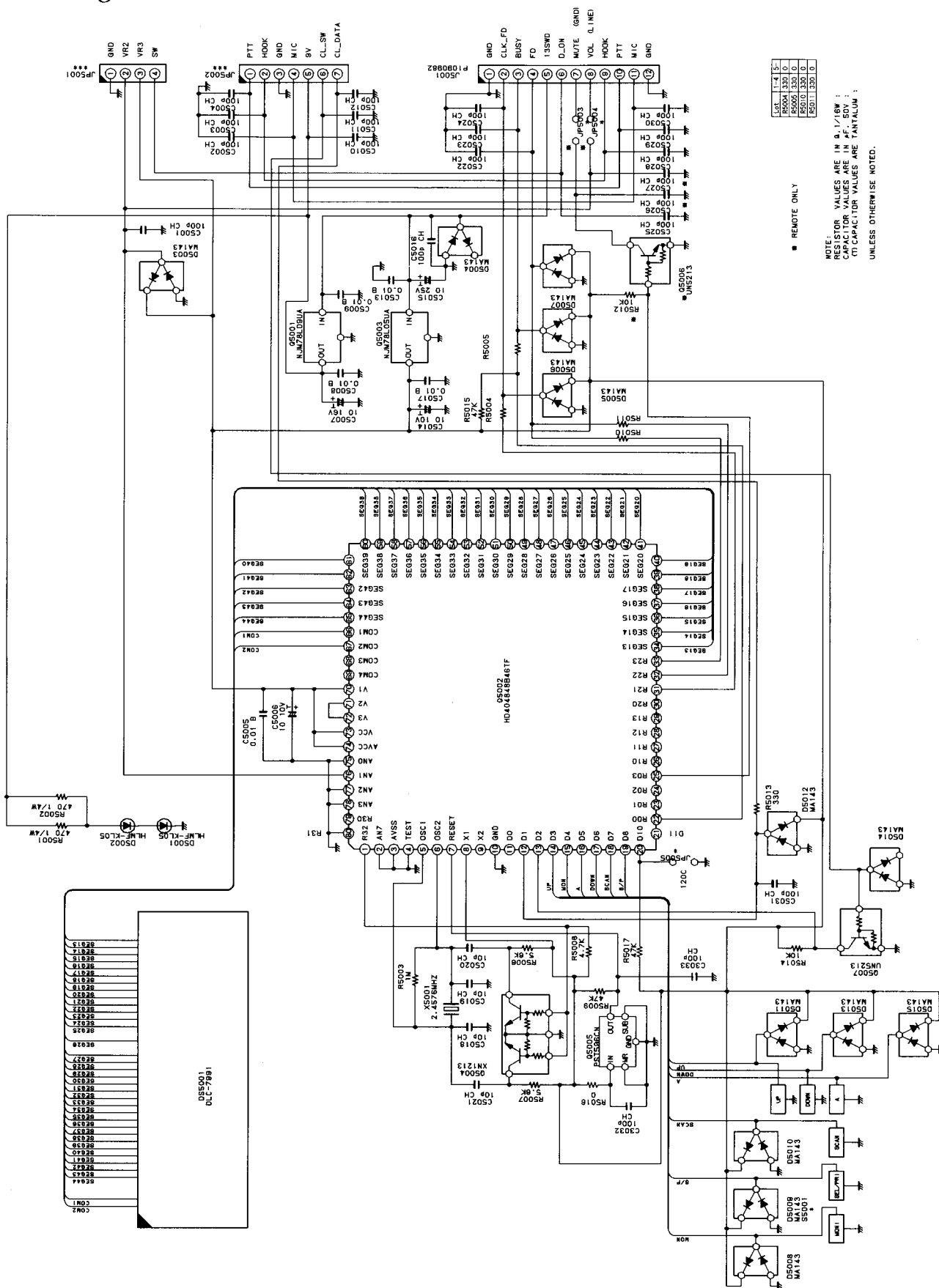

Front-A Unit (Lot. 3~)

Notes:

Parts Layout

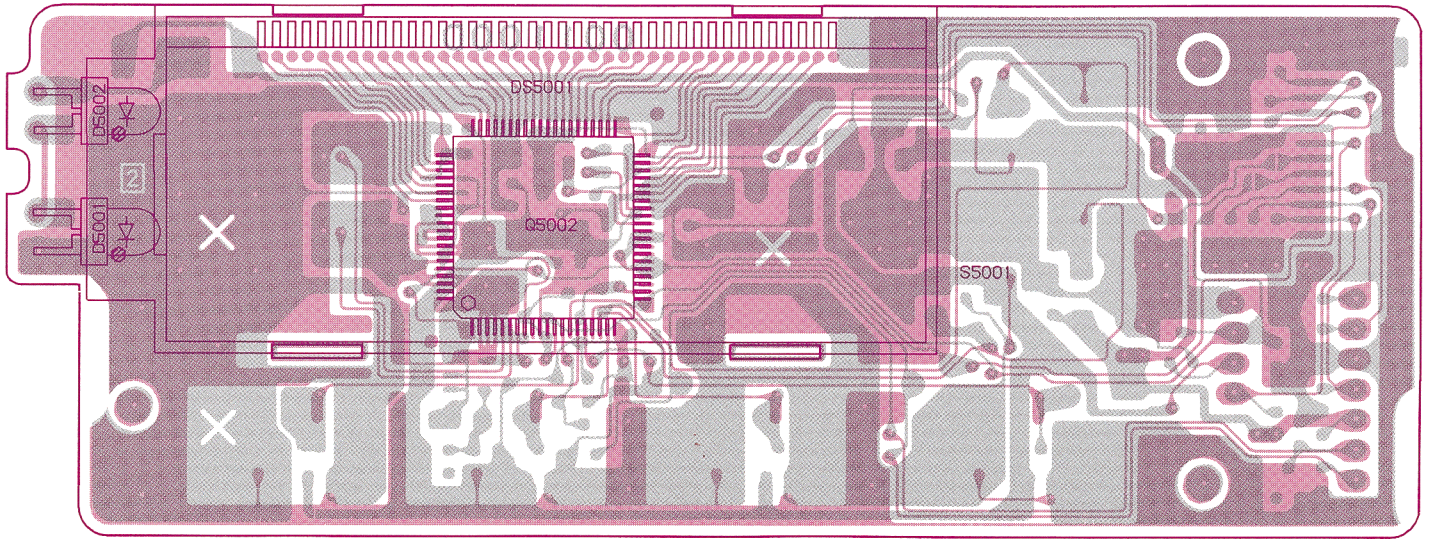

LCD Side

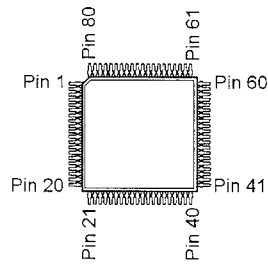

HD4074849TF
(Q5002)

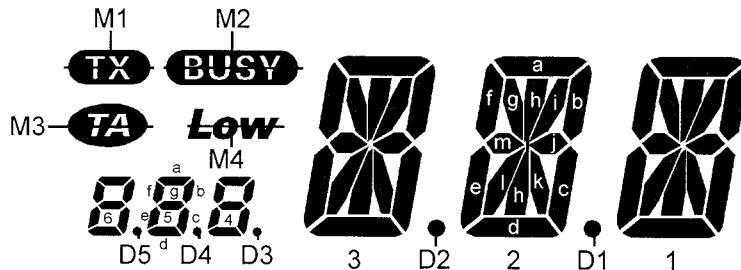

Pin No.	1	2	3	4	5	6	7	8	9	10	11	12	13	14	15	16	17	18	19	20
		COM1		D5	6d	6e	6f	6a	5a	5f	5e	5d	M2	4a	4f	4e	4d	3e	3f	3a
	COM2		D3		6c	6g	6b	M3	M1	5b	5g	5c	M4	D4	4b	4g	4c	3l	3m	3g
Pin No.	21	22	23	24	25	26	27	28	29	30	31	32	33	34	35	36	37	38	39	
	3b	3c		3d	D2	2c	2d	2e	2f	2a	2b	2j	1f	1a	1b	1c	1d	1e		
	3i	3j	3k	3h		2k	2h	2l	2m	2g	2i	1m	1g	1i	1j	1k	1h	1l	D1	

DS5001 LCD Display

Front-A Unit (Lot. 3~)

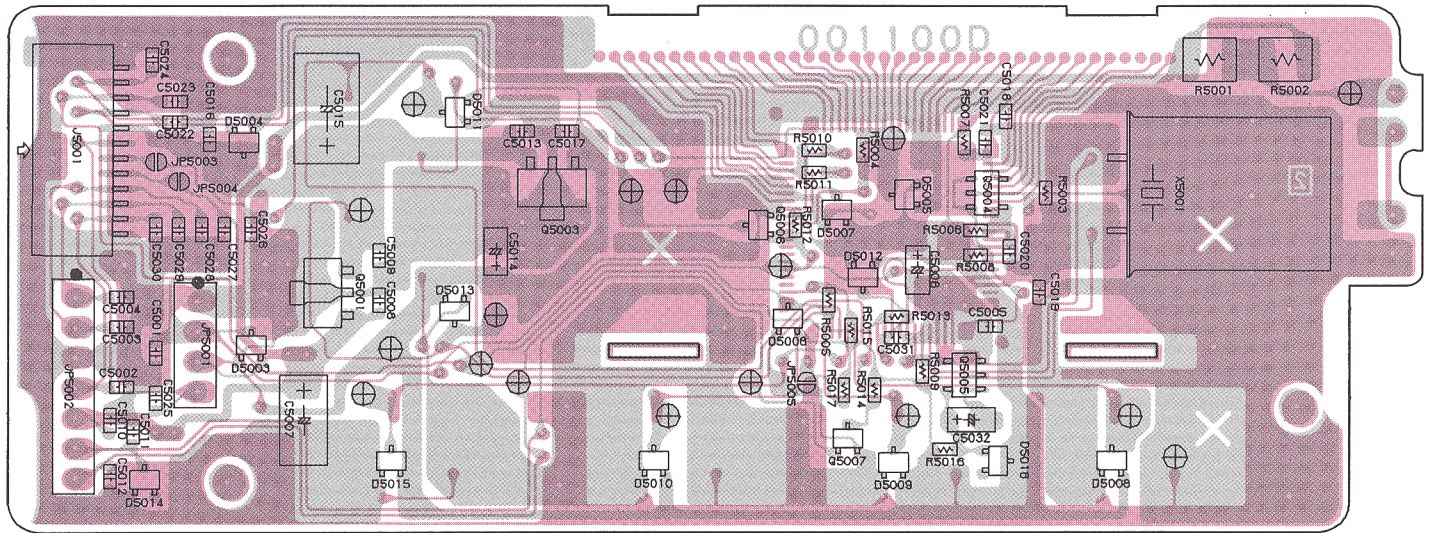

Component Side

J5001

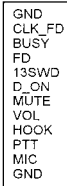

To RF Unit J1003
 (See Page 4A-7: Lot 3)
 (See Page 4A-11: Lot 4)
 (See Page 4A-15: Lot 5 ~)

JP5002

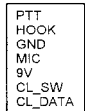

To MIC Unit JP7101
 (See Page 4F-1)

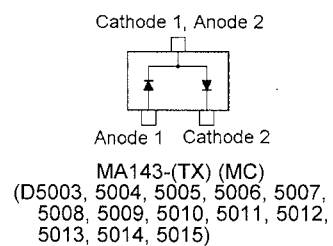
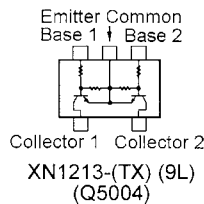
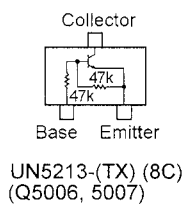
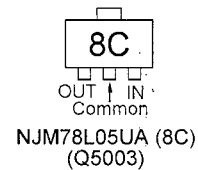
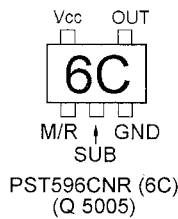
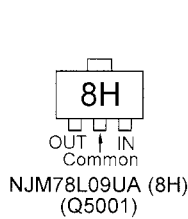

Parts List

REF.	DESCRIPTION	VALUE	V/W	TOL.	MFGR'S DESIG	VXSTD P/N	VERS.	LOT.
*** FRONT-A UNIT ***								
	PCB with Components					CB0170101	48 CHANNELS	
	PCB with Components					CB0170102	120 CHANNELS	
	Printed Circuit Board					FR001100C		1-
	Printed Circuit Board					FR001100D		3-
C 5001	CHIP CAP.	100pF	50V	CH	GRM39CH101J50PT	K22174235		1-
C 5002	CHIP CAP.	100pF	50V	CH	GRM39CH101J50PT	K22174235		1-
C 5003	CHIP CAP.	100pF	50V	CH	GRM39CH101J50PT	K22174235		1-
C 5004	CHIP CAP.	100pF	50V	CH	GRM39CH101J50PT	K22174235		1-
C 5005	CHIP CAP.	0.01uF	50V	B	GRM39B103M50PT	K22174823		1-
C 5006	TANTALUM CHIP CAP.	10uF	10V		TEMSVA1A106M-8R	K78100028		1-
C 5007	TANTALUM CHIP CAP.	10uF	16V		TESVC1C106M12R	K78120011		1-
C 5008	CHIP CAP.	0.01uF	50V	B	GRM39B103M50PT	K22174823		1-
C 5009	CHIP CAP.	0.01uF	50V	B	GRM39B103M50PT	K22174823		1-
C 5010	CHIP CAP.	100pF	50V	CH	GRM39CH101J50PT	K22174235		1-
C 5011	CHIP CAP.	100pF	50V	CH	GRM39CH101J50PT	K22174235		1-
C 5012	CHIP CAP.	100pF	50V	CH	GRM39CH101J50PT	K22174235		1-
C 5013	CHIP CAP.	0.01uF	50V	B	GRM39B103M50PT	K22174823		1-
C 5014	TANTALUM CHIP CAP.	10uF	10V		TEMSVA1A106M-8R	K78100028		1-
C 5015	TANTALUM CHIP CAP.	10uF	25V		TESVD1E106M12R	K78140018		1-
C 5016	CHIP CAP.	100pF	50V	CH	GRM39CH101J50PT	K22174235		1-
C 5017	CHIP CAP.	0.01uF	50V	B	GRM39B103M50PT	K22174823		1-
C 5018	CHIP CAP.	10pF	50V	CH	GRM39CH100D50PT	K22174211		1-
C 5019	CHIP CAP.	10pF	50V	CH	GRM39CH100D50PT	K22174211		1-
C 5020	CHIP CAP.	10pF	50V	CH	GRM39CH100D50PT	K22174211		1-
C 5021	CHIP CAP.	10pF	50V	CH	GRM39CH100D50PT	K22174211		1-
C 5022	CHIP CAP.	100pF	50V	CH	GRM39CH101J50PT	K22174235		1-
C 5023	CHIP CAP.	100pF	50V	CH	GRM39CH101J50PT	K22174235		1-
C 5024	CHIP CAP.	100pF	50V	CH	GRM39CH101J50PT	K22174235		1-
C 5025	CHIP CAP.	100pF	50V	CH	GRM39CH101J50PT	K22174235		1-
C 5026	CHIP CAP.	100pF	50V	CH	GRM39CH101J50PT	K22174235		1-
C 5027	CHIP CAP.	100pF	50V	CH	GRM39CH101J50PT	K22174235		1-
C 5028	CHIP CAP.	100pF	50V	CH	GRM39CH101J50PT	K22174235		1-
C 5029	CHIP CAP.	100pF	50V	CH	GRM39CH101J50PT	K22174235		1-
C 5030	CHIP CAP.	100pF	50V	CH	GRM39CH101J50PT	K22174235		1-
C 5031	CHIP CAP.	100pF	50V	CH	GRM39CH101J50PT	K22174235		1-
C 5032	CHIP CAP.	100pF	50V	CH	GRM39CH101J50PT	K22174235		1-
C 5033	CHIP CAP.	100pF	50V	CH	GRM39CH101J50PT	K22174235		1-
D 5001	LED				HLMF-KL05	G2090692		1-
D 5002	LED				HLMF-KL05	G2090692		1-
D 5003	DIODE				MA143-(TX)	G2070536		1-
D 5004	DIODE				MA143-(TX)	G2070536		1-
D 5005	DIODE				MA143-(TX)	G2070536		1-
D 5006	DIODE				MA143-(TX)	G2070536		1-
D 5007	DIODE				MA143-(TX)	G2070536		1-
D 5008	DIODE				MA143-(TX)	G2070536		1-
D 5009	DIODE				MA143-(TX)	G2070536		1-
D 5010	DIODE				MA143-(TX)	G2070536		1-
D 5011	DIODE				MA143-(TX)	G2070536		1-
D 5012	DIODE				MA143-(TX)	G2070536		1-
D 5013	DIODE				MA143-(TX)	G2070536		1-
D 5014	DIODE				MA143-(TX)	G2070536		1-
D 5015	DIODE				MA143-(TX)	G2070536		1-
DS5001	LCD				DLC-7998	G6090129		1-
J 5001	CONNECTOR				12FMS-1.0SP-TF	P1090982		1-
JP5006	WIRE ASSY				BLK100 B2/(3)	T9318038		3-
Q 5001	IC				NJM78L09UA TE2	G1091305		1-
Q 5002	IC				HD404848B46TF	G1092950		1-
Q 5003	IC				NJM78L05UA TE2	G1091325		1-
Q 5004	TRANSISTOR				XN1213-(TX)	G3070194		1-

Front-A Unit

REF.	DESCRIPTION	VALUE	V/W	TOL.	MFGR'S DESIG	VXSTD P/N	VERS.	LOT.
Q 5005	IC				PST596CNR	G1092588		1-
Q 5006	TRANSISTOR				UN5213-(TX)	G3070192		1-
Q 5007	TRANSISTOR				UN5213-(TX)	G3070192		1-
R 5001	CHIP RES.	470	1/4W	5%	RMC1/4 471JATP	J24245471		1-
R 5002	CHIP RES.	470	1/4W	5%	RMC1/4 471JATP	J24245471		1-
R 5003	CHIP RES.	1M	1/16W	5%	RMC1/16 105JATP	J24185105		1-
R 5004	CHIP RES.	330	1/16W	5%	RMC1/16 331JATP	J24185331		1-
R 5004	CHIP RES.	0	1/16W	5%	RMC1/16 000JATP	J24185000		5-
R 5005	CHIP RES.	330	1/16W	5%	RMC1/16 331JATP	J24185331		1-
R 5005	CHIP RES.	0	1/16W	5%	RMC1/16 000JATP	J24185000		5-
R 5006	CHIP RES.	5.6k	1/16W	5%	RMC1/16 562JATP	J24185562		1-
R 5007	CHIP RES.	5.6k	1/16W	5%	RMC1/16 562JATP	J24185562		1-
R 5008	CHIP RES.	4.7k	1/16W	5%	RMC1/16 472JATP	J24185472		1-
R 5009	CHIP RES.	47k	1/16W	5%	RMC1/16 473JATP	J24185473		1-
R 5010	CHIP RES.	330	1/16W	5%	RMC1/16 331JATP	J24185331		1-
R 5010	CHIP RES.	0	1/16W	5%	RMC1/16 000JATP	J24185000		5-
R 5011	CHIP RES.	330	1/16W	5%	RMC1/16 331JATP	J24185331		1-
R 5011	CHIP RES.	0	1/16W	5%	RMC1/16 000JATP	J24185000		5-
R 5012	CHIP RES.	10k	1/16W	5%	RMC1/16 103JATP	J24185103		1-
R 5013	CHIP RES.	330	1/16W	5%	RMC1/16 331JATP	J24185331		1-
R 5014	CHIP RES.	10k	1/16W	5%	RMC1/16 103JATP	J24185103		1-
R 5015	CHIP RES.	47k	1/16W	5%	RMC1/16 473JATP	J24185473		1-
R 5016	CHIP RES.	0	1/16W	5%	RMC1/16 000JATP	J24185000		1-
R 5017	CHIP RES.	47k	1/10W	5%	RMC1/10T 473J	J24205473		1-
R 5017	CHIP RES.	47k	1/16W	5%	RMC1/16 473JATP	J24185473		3-
X 5001	XTAL	2.4576MHz			HC-49/U.2S 2.4576MHz	H0103166		1-
	LCD HOLDER					RA0014900		1-
	LIGHT GUIDE					RA0013200		1-
	REFLECTOR SHEET					RA0013500		1-
	DIFFUSER SHEET					RA0013600		1-
	INTER CONNECTOR					RA0013700		1-
	SPONGE RUBBER (2pcs)					R7130200		1-
	LED SPACER (2pcs)				LH-5-4	S6000237		1-

Front-B Unit

Notes:

Parts Layout

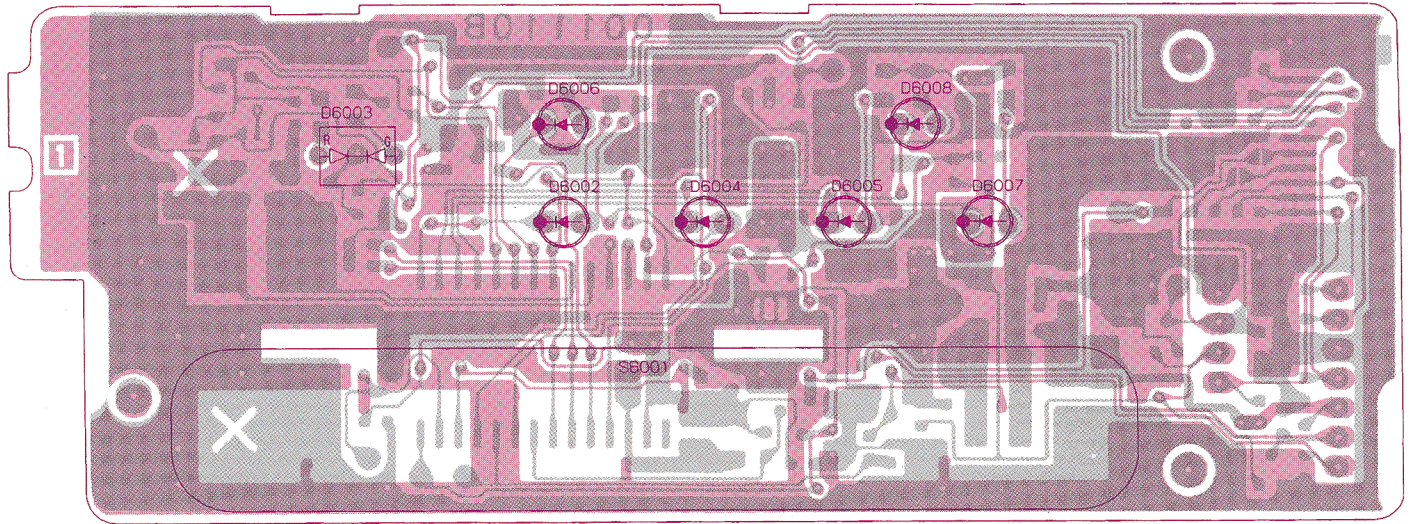

LED Side

Front-B Unit

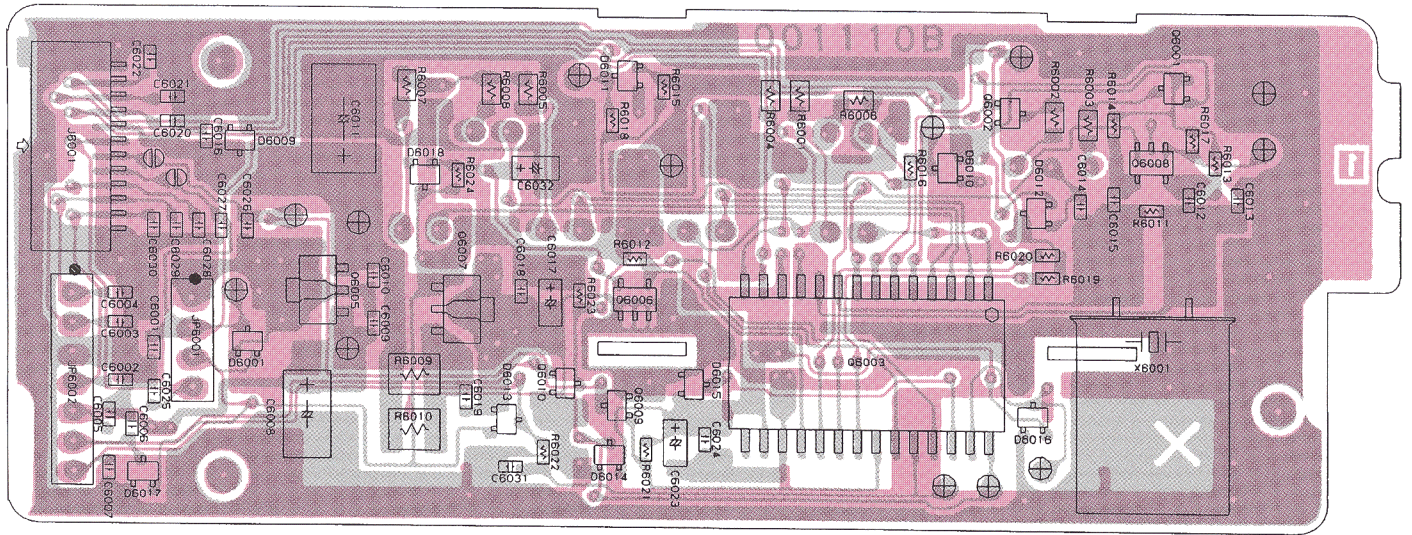

J6001

GND
CLK FD
BUSY
FD
13SWD
D_ON
MUTE
VOL
HCOK
PTT
MIC
GND

To RF Unit J1003
(See Page 4A-3)

JP6002

PTT
HOOK
GND
MIC
9V
CL_SW
CL_DATA

To MIC Unit JP7101
(See Page 4F-1)

Component Side

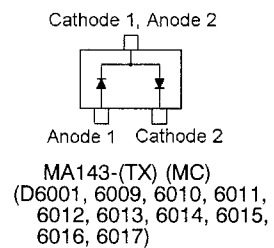
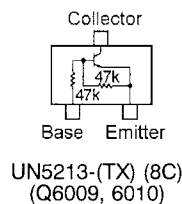
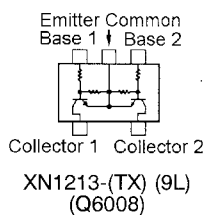
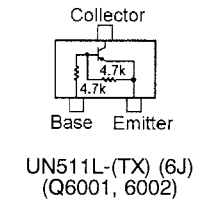
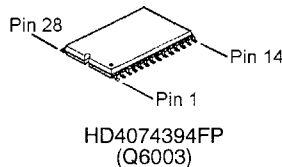
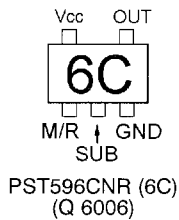
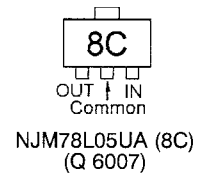
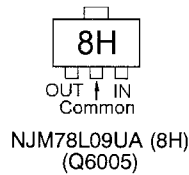
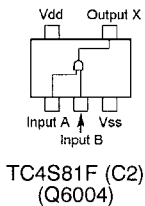

Front-B Unit (Lot. 3~)

Circuit Diagram

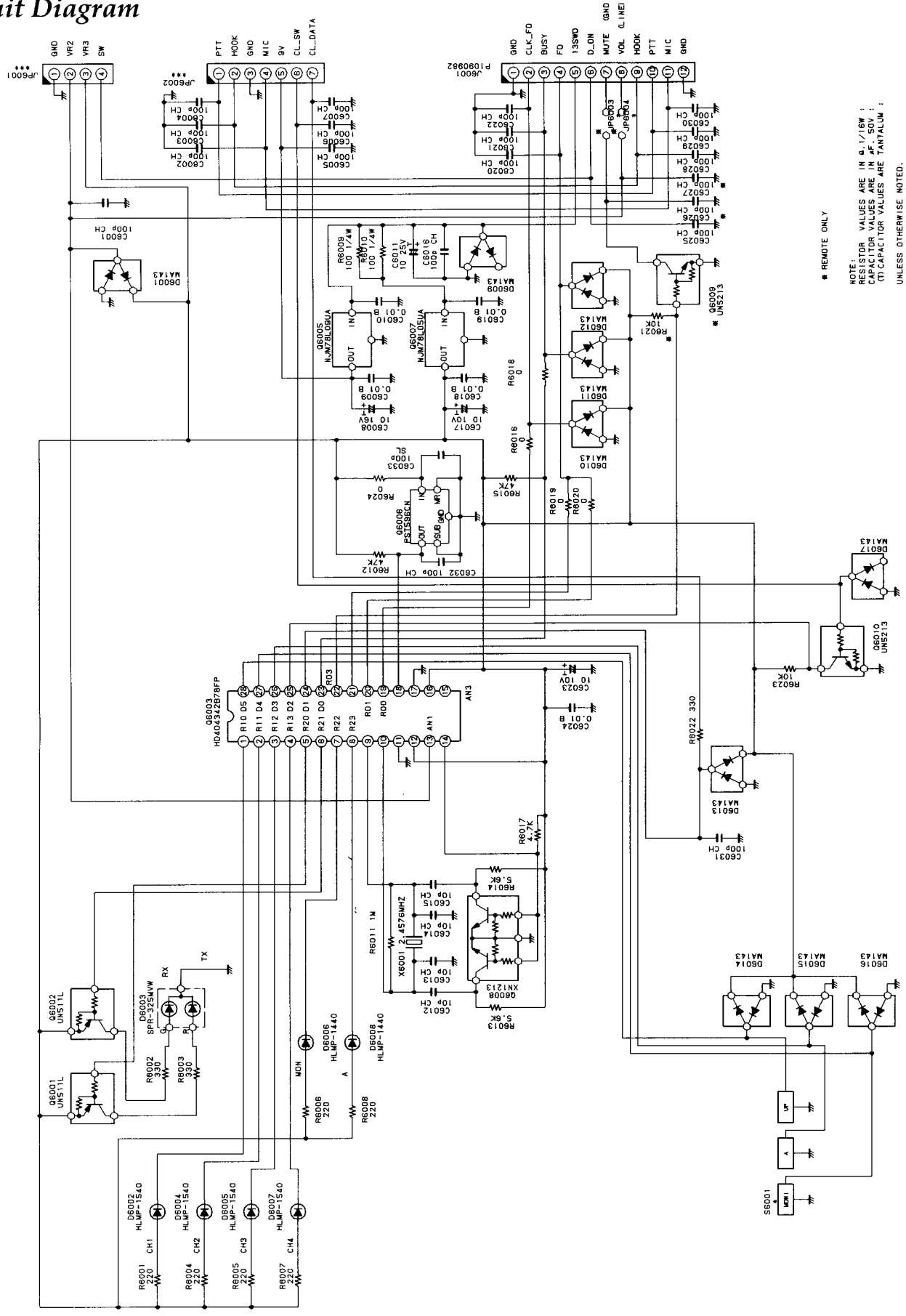

■ REMOTE ONLY

NOTE: RESISTOR VALUES ARE IN OHMS UNLESS OTHERWISE NOTED.
CAPACITOR VALUES ARE IN MICROFARADS UNLESS OTHERWISE NOTED.
(T) CAPACITOR VALUES ARE TANTALUM.

Front-B Unit (Lot. 3~)

Notes:

Parts Layout

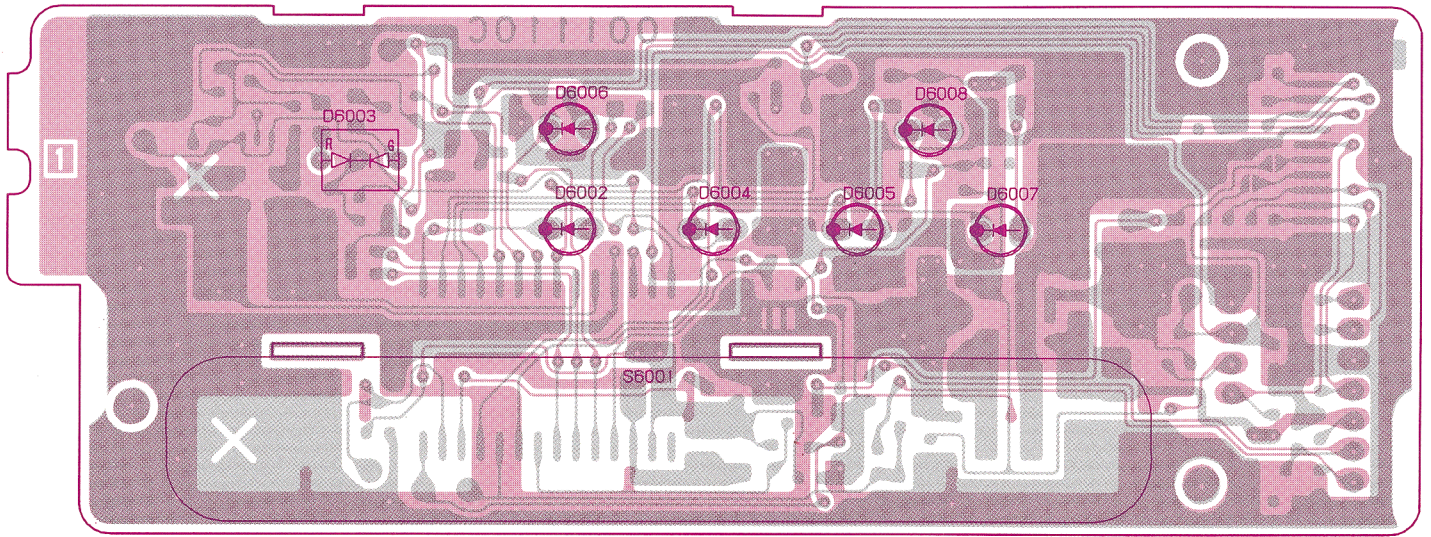

LED Side

Front-B Unit (Lot. 3~)

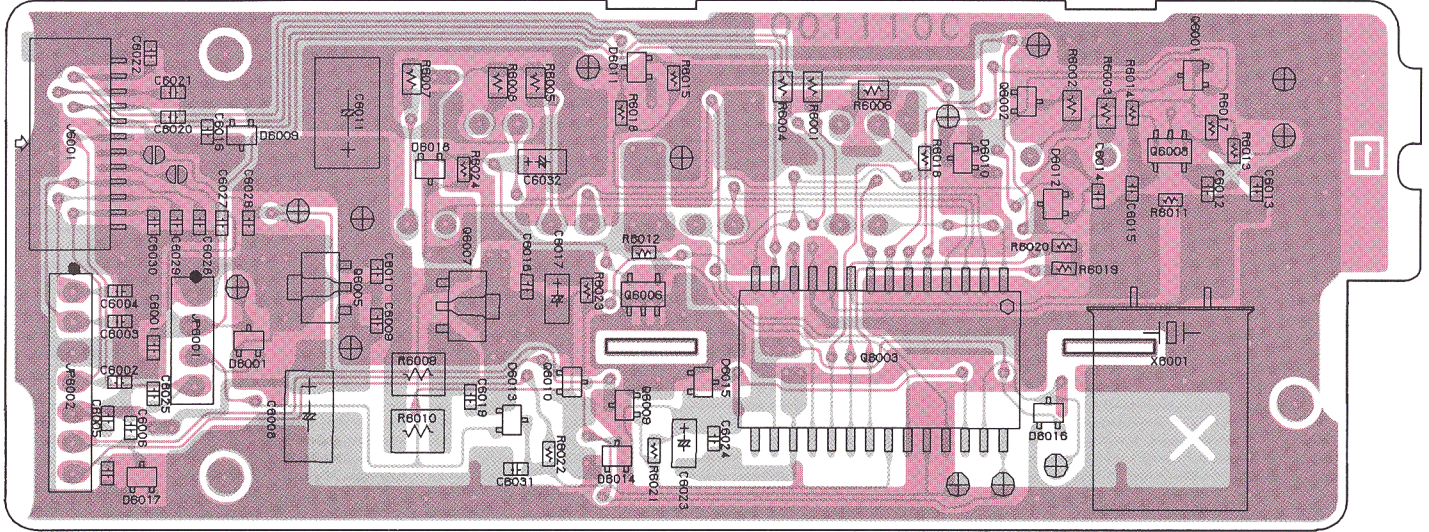

Component Side

J6001



JP6002

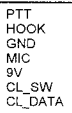

To MIC Unit JP7101
(See Page 4F-1)

To RF Unit J1003
(See Page 4A-7: Lot 3)
(See Page 4A-11: Lot 4)
(See Page 4A-15: Lot 5 ~)

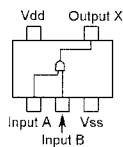

TC4S81F (C2)
(Q6004)

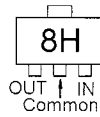

NJM78L09UA (8H)
(Q6005)

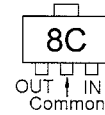

NJM78L05UA (8C)
(Q6007)

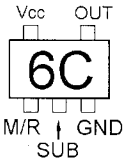

PST596CNR (6C)
(Q6006)

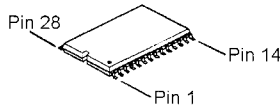

HD4074394FP
(Q6003)

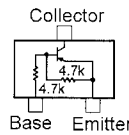

UN511L-(TX) (6J)
(Q6001, 6002)

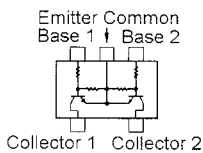

XN1213-(TX) (9L)
(Q6008)

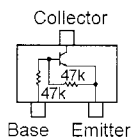

UN5213-(TX) (8C)
(Q6009, 6010)

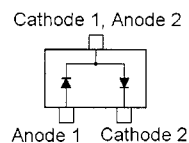

MA143-(TX) (MC)
(D6001, 6009, 6010, 6011,
6012, 6013, 6014, 6015,
6016, 6017)

Parts List

REF.	DESCRIPTION	VALUE	V/W	TOL.	MFGR'S DESIG	VXSTD P/N	VERS.	LOT.
*** FRONT-B UNIT ***								
PCB with Components						CB0171101	4 CHANNELS	
	Printed Circuit Board					FR001110B		1-
	Printed Circuit Board					FR001110C		3-
C 6001	CHIP CAP.	100pF	50V	CH	GRM39CH101J50PT	K22174235		1-
C 6002	CHIP CAP.	100pF	50V	CH	GRM39CH101J50PT	K22174235		1-
C 6003	CHIP CAP.	100pF	50V	CH	GRM39CH101J50PT	K22174235		1-
C 6004	CHIP CAP.	100pF	50V	CH	GRM39CH101J50PT	K22174235		1-
C 6005	CHIP CAP.	100pF	50V	CH	GRM39CH101J50PT	K22174235		1-
C 6006	CHIP CAP.	100pF	50V	CH	GRM39CH101J50PT	K22174235		1-
C 6007	CHIP CAP.	100pF	50V	CH	GRM39CH101J50PT	K22174235		1-
C 6008	TANTALUM CHIP CAP.	10uF	16V		TESVC1C106M12R	K78120011		1-
C 6009	CHIP CAP.	0.01uF	50V	B	GRM39B103M50PT	K22174823		1-
C 6010	CHIP CAP.	0.01uF	50V	B	GRM39B103M50PT	K22174823		1-
C 6011	TANTALUM CHIP CAP.	10uF	25V		TESVD1E106M12R	K78140018		1-
C 6012	CHIP CAP.	10pF	50V	CH	GRM39CH100D50PT	K22174211		1-
C 6013	CHIP CAP.	10pF	50V	CH	GRM39CH100D50PT	K22174211		1-
C 6014	CHIP CAP.	10pF	50V	CH	GRM39CH100D50PT	K22174211		1-
C 6015	CHIP CAP.	10pF	50V	CH	GRM39CH100D50PT	K22174211		1-
C 6016	CHIP CAP.	100pF	50V	CH	GRM39CH101J50PT	K22174235		1-
C 6017	TANTALUM CHIP CAP.	10uF	10V		TEMSVA1A106M-8R	K78100028		1-
C 6018	CHIP CAP.	0.01uF	50V	B	GRM39B103M50PT	K22174823		1-
C 6019	CHIP CAP.	0.01uF	50V	B	ECUV1H103KBV	K22179626		1-
C 6020	CHIP CAP.	100pF	50V	CH	GRM39CH101J50PT	K22174235		1-
C 6021	CHIP CAP.	100pF	50V	CH	GRM39CH101J50PT	K22174235		1-
C 6022	CHIP CAP.	100pF	50V	CH	GRM39CH101J50PT	K22174235		1-
C 6023	TANTALUM CHIP CAP.	10uF	10V		TEMSVA1A106M-8R	K78100028		1-
C 6024	CHIP CAP.	0.01uF	50V	B	GRM39B103M50PT	K22174823		1-
C 6025	CHIP CAP.	100pF	50V	CH	GRM39CH101J50PT	K22174235		1-
C 6026	CHIP CAP.	100pF	50V	CH	GRM39CH101J50PT	K22174235		1-
C 6027	CHIP CAP.	100pF	50V	CH	GRM39CH101J50PT	K22174235		1-
C 6028	CHIP CAP.	100pF	50V	CH	GRM39CH101J50PT	K22174235		1-
C 6029	CHIP CAP.	100pF	50V	CH	GRM39CH101J50PT	K22174235		1-
C 6030	CHIP CAP.	100pF	50V	CH	GRM39CH101J50PT	K22174235		1-
C 6031	CHIP CAP.	100pF	50V	CH	GRM39CH101J50PT	K22174235		1-
C 6032	CHIP CAP.	100pF	50V	CH	GRM39CH101J50PT	K22174235		1-
C 6033	CERAMIC CAP.	100pF	50V	SL	DD105SL101J50	K00175101		1-
D 6001	DIODE				MA143-(TX)	G2070536		1-
D 6002	LED				HLMP-1540	G2090696		1-
D 6003	LED				SPR-325MVWT31	G2050016		1-
D 6004	LED				HLMP-1540	G2090696		1-
D 6005	LED				HLMP-1540	G2090696		1-
D 6006	LED				HLMP-1440	G2090695		1-
D 6007	LED				HLMP-1540	G2090696		1-
D 6008	LED				HLMP-1440	G2090695		1-
D 6009	DIODE				MA143-(TX)	G2070536		1-
D 6010	DIODE				MA143-(TX)	G2070536		1-
D 6011	DIODE				MA143-(TX)	G2070536		1-
D 6012	DIODE				MA143-(TX)	G2070536		1-
D 6013	DIODE				MA143-(TX)	G2070536		1-
D 6014	DIODE				MA143-(TX)	G2070536		1-
D 6015	DIODE				MA143-(TX)	G2070536		1-
D 6016	DIODE				MA143-(TX)	G2070536		1-
D 6017	DIODE				MA143-(TX)	G2070536		1-
J 6001	CONNECTOR				12FMS-1.0SP-TF	P1090982		1-
JP6005	WIRE ASSY				BLK100 B2/(3)	T9318038		3-
Q 6001	TRANSISTOR				UN511L-(TX)	G3070196		1-
Q 6002	TRANSISTOR				UN511L-(TX)	G3070196		1-
Q 6003	IC				HD404342B78FP	G1092771		1-
Q 6005	IC				NJM78L09UA TE2	G1091305		1-

Front-B Unit

REF.	DESCRIPTION	VALUE	V/W	TOL.	MFGR'S DESIG	VXSTD P/N	VERS.	LOT.
Q 6006	IC				PST596CNR	G1092588		1-
Q 6007	IC				NJM78L05UA TE2	G1091325		1-
Q 6008	TRANSISTOR				XN1213-(TX)	G3070194		1-
Q 6009	TRANSISTOR				UN5213-(TX)	G3070192		1-
Q 6010	TRANSISTOR				UN5213-(TX)	G3070192		1-
R 6001	CHIP RES.	220	1/10W	5%	RMC1/10T 221J	J24205221		1-
R 6002	CHIP RES.	330	1/10W	5%	RMC1/10T 331J	J24205331		1-
R 6003	CHIP RES.	330	1/10W	5%	RMC1/10T 331J	J24205331		1-
R 6004	CHIP RES.	220	1/10W	5%	RMC1/10T 221J	J24205221		1-
R 6005	CHIP RES.	220	1/10W	5%	RMC1/10T 221J	J24205221		1-
R 6006	CHIP RES.	220	1/10W	5%	RMC1/10T 221J	J24205221		1-
R 6007	CHIP RES.	220	1/10W	5%	RMC1/10T 221J	J24205221		1-
R 6008	CHIP RES.	220	1/10W	5%	RMC1/10T 221J	J24205221		1-
R 6009	CHIP RES.	100	1/4W	5%	RMC1/4 101JATP	J24245101		1-
R 6010	CHIP RES.	100	1/4W	5%	RMC1/4 101JATP	J24245101		1-
R 6011	CHIP RES.	1M	1/16W	5%	RMC1/16 105JATP	J24185105		1-
R 6012	CHIP RES.	47k	1/16W	5%	RMC1/16 473JATP	J24185473		1-
R 6013	CHIP RES.	5.6k	1/16W	5%	RMC1/16 562JATP	J24185562		1-
R 6014	CHIP RES.	5.6k	1/16W	5%	RMC1/16 562JATP	J24185562		1-
R 6015	CHIP RES.	47k	1/16W	5%	RMC1/16 473JATP	J24185473		1-
R 6016	CHIP RES.	330	1/16W	5%	RMC1/16 331JATP	J24185331		1-
R 6016	CHIP RES.	0	1/16W	5%	RMC1/16 000JATP	J24185000		5-
R 6017	CHIP RES.	4.7k	1/16W	5%	RMC1/16 472JATP	J24185472		1-
R 6018	CHIP RES.	330	1/16W	5%	RMC1/16 331JATP	J24185331		1-
R 6019	CHIP RES.	330	1/16W	5%	RMC1/16 331JATP	J24185331		1-
R 6019	CHIP RES.	0	1/16W	5%	RMC1/16 000JATP	J24185000		5-
R 6020	CHIP RES.	330	1/16W	5%	RMC1/16 331JATP	J24185331		1-
R 6020	CHIP RES.	0	1/16W	5%	RMC1/16 000JATP	J24185000		5-
R 6021	CHIP RES.	10k	1/16W	5%	RMC1/16 103JATP	J24185103		1-
R 6022	CHIP RES.	330	1/16W	5%	RMC1/16 331JATP	J24185331		1-
R 6023	CHIP RES.	10k	1/16W	5%	RMC1/16 103JATP	J24185103		1-
R 6024	CHIP RES.	0	1/16W	5%	RMC1/16 000JATP	J24185000		1-
X 6001	XTAL	2.4576MHz			HC-49/U.2S 2.4576MHz	H0103166		1-
	LED SPACER (6pcs)				LH-5-2	S6000235		1-
	LED SPACER				LH-36-3	S6000301		1-

Circuit Diagram

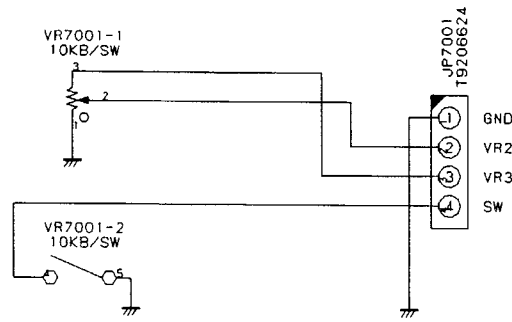

Parts Layout

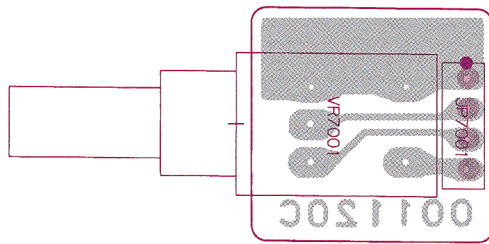

Component Side

GND
VR2
VR3
SW

To FRONT-A, FRONT-B Unit
(See Page 4C-4, 4D-4)

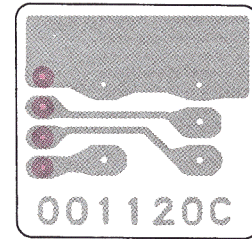

Solder Side

Parts List

REF.	DESCRIPTION	VALUE	V/W	TOL.	MFGR'S DESIG	VXSTD P/N	VERS.	LOT.
*** VR UNIT ***								
	PCB with Component					CB0172001		1-
	Printed Circuit Board					FR001120C		1-
JP 7001	WIRE ASSY					T9206624		1-
VR7001	POT.	10k			RK0971111 10KB/SW	J60800228		1-

VR Unit

Notes:

Circuit Diagram

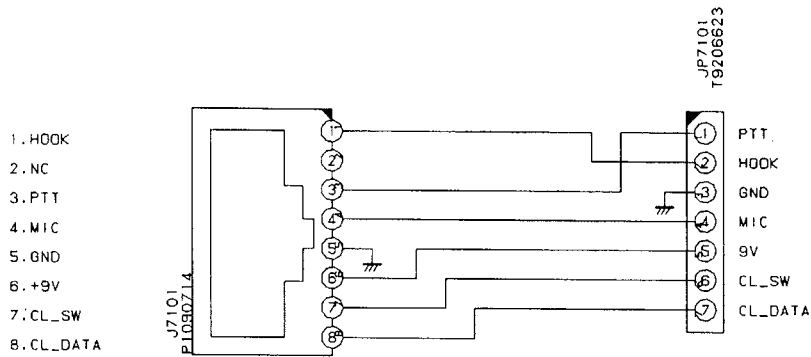

Parts Layout

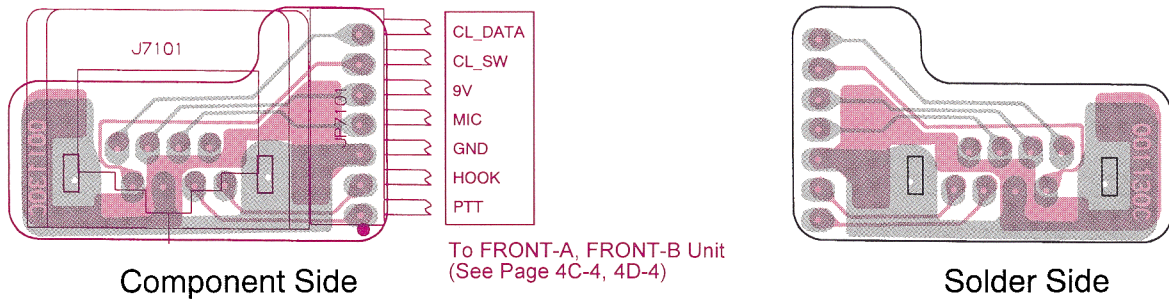

Parts List

REF.	DESCRIPTION	VALUE	V/W	TOL.	MFGR'S DESIG	VXSTD P/N	VERS.	LOT.
*** MIC UNIT ***								
	PCB with Component					CB0173001		1-
	Printed Circuit Board					FR001130C		1-
J 7101	CONNECTOR				R41-2509H	P1090714		1-
JP 7101	WIRE ASSY				A0834	T9206623		1-

MIC Unit

Notes:



Copyright 2001
VERTEX STANDARD CO., LTD.
All rights reserved

No portion of this manual
may be reproduced without
the permission of
VERTEX STANDARD CO., LTD.

Printed in Japan.

0111s-DT

