

Circuit Diagram

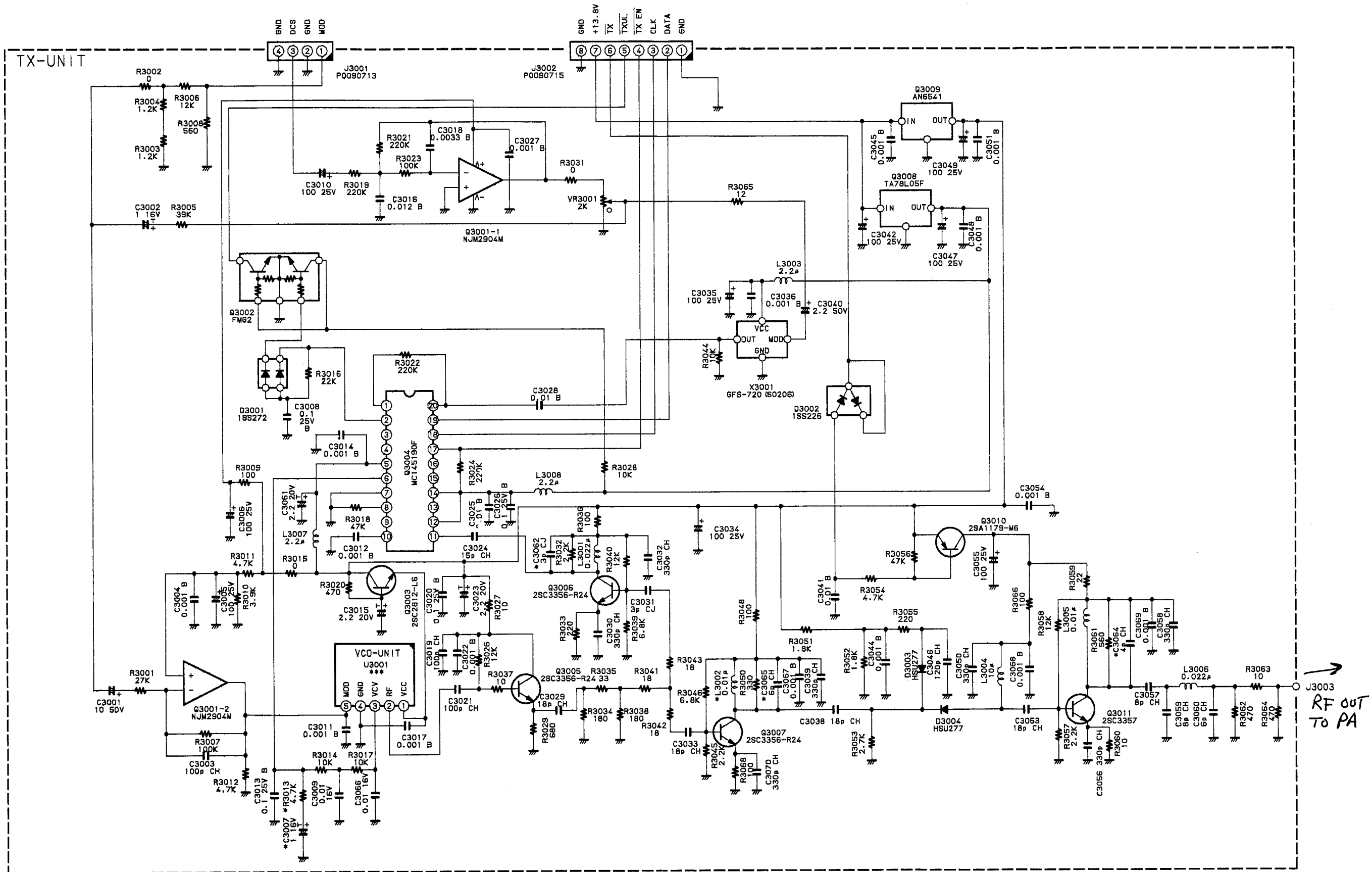

TX UNIT

Parts Layout

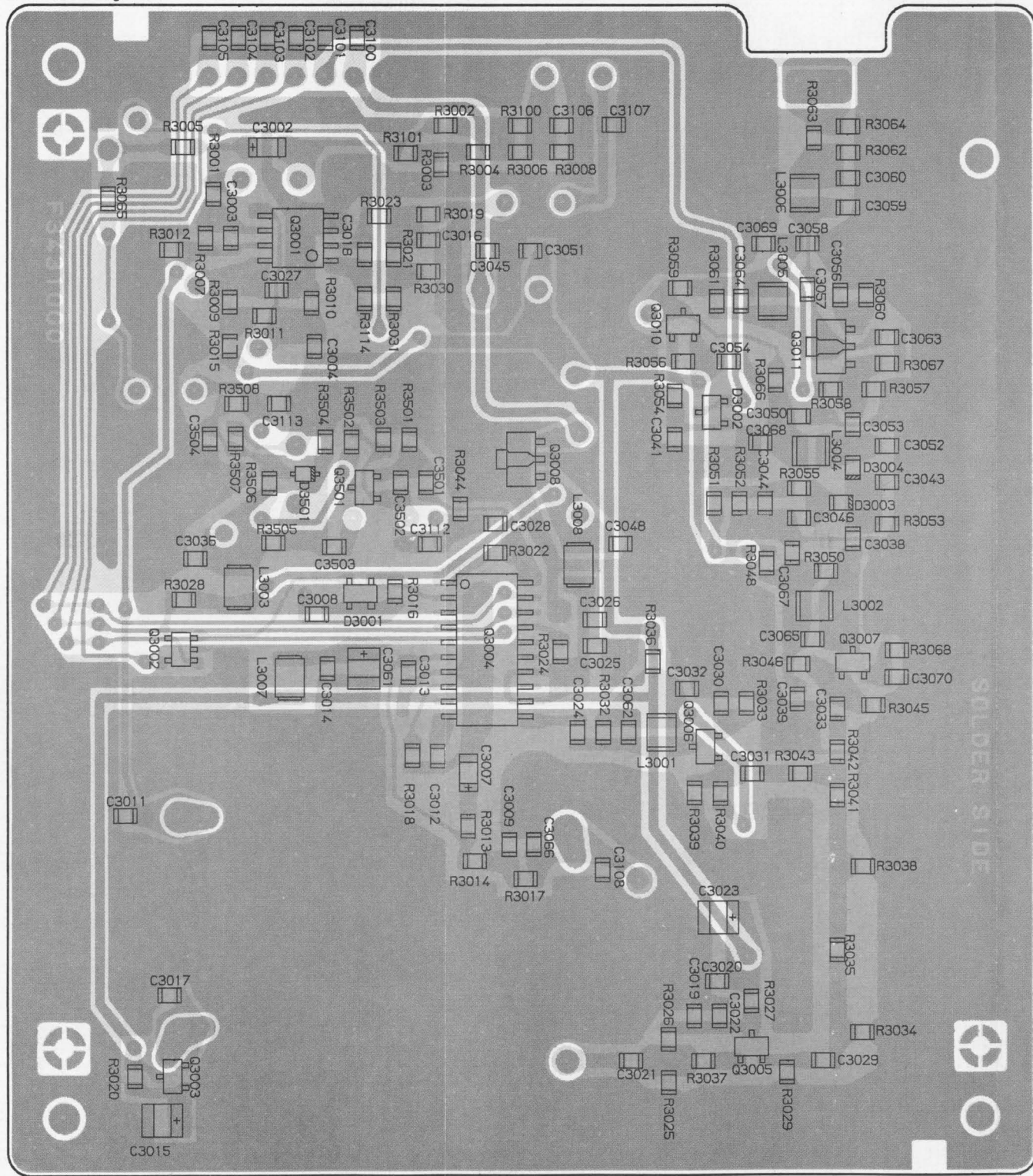

obverse view of chip side

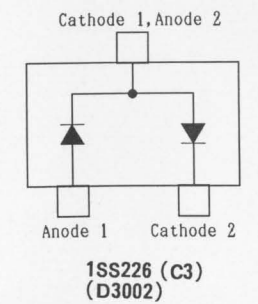
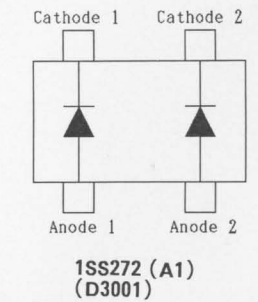
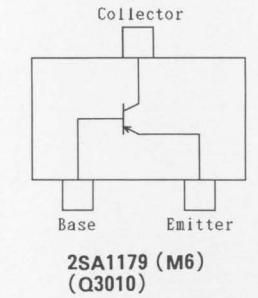
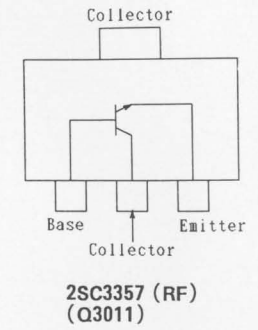
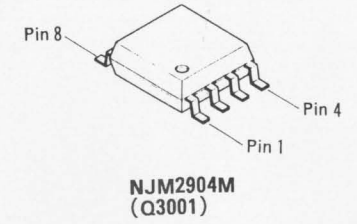
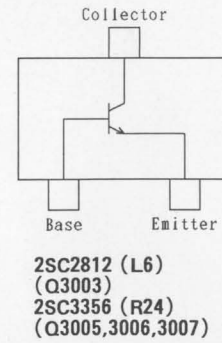
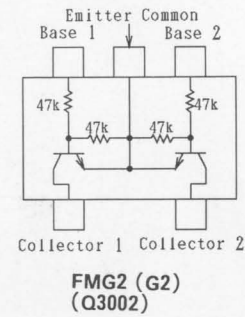
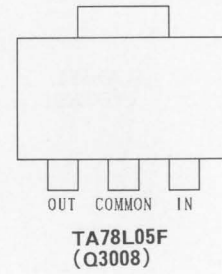
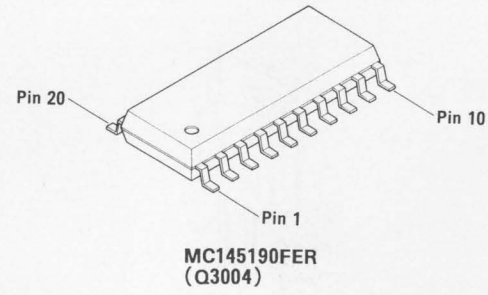

REF.	DESCRIPTION	VALUE	WV	TOL.	MPGR'S DESIG	YAESU P/N	VERS.	LOT.
*** TX UNIT ***								
	P.C.B. with Components (W/O TX VCO UNIT, J3003 CONNECTOR, SHIELD COVER, SHIELD CASE, SHIELD FRAME, SPECIAL NUT)					CA1254001	TYP D	
						CA1254002	TYP E	4-
						CA1254003	TYP F	4-
						CA1254004	TYP C	5-
						CA1254005	TYP A	5-
	P.C.B. with Components (W/O J3003 CONNECTOR, SHIELD COVER, SHIELD CASE, SHIELD FRAME, SPECIAL NUT)					CS1356001	TYP D	
						CS1356002	TYP E	4-
						CS1356003	TYP F	4-
						CS1356004	TYP C	5-
						CS1356005	TYP A	5-
	Printed Circuit Board					F3431000		
C 3001	AL. ELECTRO. CAP.				25V101M6X11	K46140005		
C 3001	AL. ELECTRO. CAP.	10uF	50V		50V100M5X11TR5	K46170021		2-
C 3002	TANTALUM CHIP CAP.	1uF	16V		TESVA1C105M1-8R	K78120009		
C 3003	CHIP CAP.	100pF	50V	CH	GRM40CH101J50PT	K22170235		
C 3004	CHIP CAP.	0.001uF	50V	B	GRM40B102M50PT	K22170805		
C 3005	AL. ELECTRO. CAP.	100uF	25V		25V101M6X11TR5	K46140005		
C 3006	AL. ELECTRO. CAP.	100uF	25V		25V101M6X11TR5	K46140005		
C 3007	TANTALUM CHIP CAP.	2.2uF	6.3V		TESVA0J225M1-8R	K78080009	TYP A	5-
C 3007	TANTALUM CHIP CAP.	1uF	16V		TESVA1C105M1-8R	K78120009	TYP C	5-
C 3007	TANTALUM CHIP CAP.	1uF	16V		TESVA1C105M1-8R	K78120009	TYP D	
C 3007	TANTALUM CHIP CAP.	1uF	16V		TESVA1C105M1-8R	K78120009	TYP E	5-
C 3007	TANTALUM CHIP CAP.	1uF	16V		TESVA1C105M1-8R	K78120009	TYP F	5-
C 3008	CHIP CAP.	0.1uF	25V	B	GRM40B104M25PT	K22140811		
C 3009	FILM CAP.	0.01	16V		ECHU1C103JB5	K57120007		
C 3010	AL. ELECTRO. CAP.	100uF	25V		25V101M6X11TR5	K46140005		
C 3011	CHIP CAP.	0.001uF	50V	B	GRM40B102M50PT	K22170805		
C 3012	CHIP CAP.	0.001uF	50V	B	GRM40B102M50PT	K22170805		
C 3013	CHIP CAP.	0.1uF	25V	B	GRM40B104M25PT	K22140811		
C 3014	CHIP CAP.	0.001uF	50V	B	GRM40B102M50PT	K22170805		
C 3015	TANTALUM CHIP CAP.	2.2uF	20V		TESVB21D225M8R	K78130010		
C 3016	CHIP CAP.	0.012	50V	B	GRM40B123M50PT	K22170818		
C 3017	CHIP CAP.	0.001uF	50V	B	GRM40B102M50PT	K22170805		
C 3018	CHIP CAP.	0.0033uF	50V	B	GRM40B332M50PT	K22170811		
C 3019	CHIP CAP.	100pF	50V	CH	GRM40CH101J50PT	K22170235		
C 3020	CHIP CAP.	0.1uF	25V	B	GRM40B104M25PT	K22140811		
C 3021	CHIP CAP.	100pF	50V	CH	GRM40CH101J50PT	K22170235		
C 3022	CHIP CAP.	0.001uF	50V	B	GRM40B102M50PT	K22170805		
C 3023	TANTALUM CHIP CAP.	2.2uF	20V		TESVB21D225M8R	K78130010		
C 3024	CHIP CAP.	15pF	50V	CH	GRM40CH150J50PT	K22170215		
C 3025	CHIP CAP.	0.01uF	50V	B	GRM40B103M50PT	K22170817		
C 3026	CHIP CAP.	0.1uF	25V	B	GRM40B104M25PT	K22140811		
C 3027	CHIP CAP.	0.001uF	50V	B	GRM40B102M50PT	K22170805		
C 3028	CHIP CAP.	0.01uF	50V	B	GRM40B103M50PT	K22170817		
C 3029	CHIP CAP.	18pF	50V	CH	GRM40CH180J50PT	K22170217		
C 3030	CHIP CAP.	330pF	50V	CH	GRM40CH331J50PT	K22170247		
C 3031	CHIP CAP.	3pF	50V	CJ	GRM40CJ030C50PT	K22170204		

REF.	DESCRIPTION	VALUE	WV	TOL.	MFRG'S DESIG	YAESU P/N	VERS.	LOT.
C 3032	CHIP CAP.	330pF	50V	CH	GRM40CH331J50PT	K22170247		
C 3033	CHIP CAP.	18pF	50V	CH	GRM40CH180J50PT	K22170217		
C 3034	AL. ELECTRO. CAP.	100uF	25V		25V101M6X11TR5	K46140005		
C 3035	AL. ELECTRO. CAP.	100uF	25V		25V101M6X11TR5	K46140005		
C 3036	CHIP CAP.	0.001uF	50V	B	GRM40B102M50PT	K22170805		
C 3038	CHIP CAP.	18pF	50V	CH	GRM40CH180J50PT	K22170217		
C 3039	CHIP CAP.	330pF	50V	CH	GRM40CH331J50PT	K22170247		
C 3040	AL. ELECTRO. CAP.	2.2uF	50V		50V2R2M5X11TR5	K46170018		
C 3041	CHIP CAP.	0.01uF	50V	B	GRM40B103M50PT	K22170817		
C 3042	AL. ELECTRO. CAP.	100uF	25V		25V101M6X11TR5	K46140005		
C 3044	CHIP CAP.	0.001uF	50V	B	GRM40B102M50PT	K22170805		
C 3045	CHIP CAP.	0.001uF	50V	B	GRM40B102M50PT	K22170805		
C 3046	CHIP CAP.	120pF	50V	CH	GRM40CH121J50PT	K22170237		
C 3047	AL. ELECTRO. CAP.	100uF	25V		25V101M6X11TR5	K46140005		
C 3048	CHIP CAP.	0.001uF	50V	B	GRM40B102M50PT	K22170805		
C 3049	AL. ELECTRO. CAP.	100uF	25V		25V101M6X11TR5	K46140005		
C 3050	CHIP CAP.	330pF	50V	CH	GRM40CH331J50PT	K22170247		
C 3051	CHIP CAP.	0.001uF	50V	B	GRM40B102M50PT	K22170805		
C 3053	CHIP CAP.	18pF	50V	CH	GRM40CH180J50PT	K22170217		
C 3054	CHIP CAP.	0.001uF	50V	B	GRM40B102M50PT	K22170805		
C 3055	AL. ELECTRO. CAP.	100uF	25V		25V101M6X11TR5	K46140005		
C 3056	CHIP CAP.	330pF	50V	CH	GRM40CH331J50PT	K22170247		
C 3057	CHIP CAP.	8pF	50V	CH	GRM40CH080D50PT	K22170209		
C 3058	CHIP CAP.	330pF	50V	CH	GRM40CH331J50PT	K22170247		
C 3059	CHIP CAP.	8pF	50V	CH	GRM40CH080D50PT	K22170209		
C 3060	CHIP CAP.	6pF	50V	CH	GRM40CH060D50PT	K22170207		
C 3061	TANTALUM CHIP CAP.	2.2uF	20V		TESVB21D225M8R	K78130010		
C 3062	CHIP CAP.	6pF	50V	CH	GRM40CH060D50PT	K22170207	TYP A	5-
C 3062	CHIP CAP.	3pF	50V	CJ	GRM40CJ030C50PT	K22170204	TYP C	5-
C 3062	CHIP CAP.	3pF	50V	CJ	GRM40CJ030C50PT	K22170204	TYP D	
C 3062	CHIP CAP.	3pF	50V	CJ	GRM40CJ030C50PT	K22170204	TYP E	5-
C 3062	CHIP CAP.	3pF	50V	CJ	GRM40CJ030C50PT	K22170204	TYP F	5-
C 3064	CHIP CAP.	6pF	50V	CH	GRM40CH060D50PT	K22170207	TYP A	5-
C 3064	CHIP CAP.	6pF	50V	CH	GRM40CH060D50PT	K22170207	TYP C	5-
C 3064	CHIP CAP.	4pF	50V	CH	GRM40CH040C50PT	K22170205	TYP D	
C 3064	CHIP CAP.	4pF	50V	CH	GRM40CH040C50PT	K22170205	TYP E	5-
C 3064	CHIP CAP.	4pF	50V	CH	GRM40CH040C50PT	K22170205	TYP F	5-
C 3065	CHIP CAP.	4pF	50V	CH	GRM40CH040C50PT	K22170205	TYP A	5-
C 3065	CHIP CAP.	4pF	50V	CH	GRM40CH040C50PT	K22170205	TYP C	5-
C 3065	CHIP CAP.	6pF	50V	CH	GRM40CH060D50PT	K22170207	TYP D	
C 3065	CHIP CAP.	6pF	50V	CH	GRM40CH060D50PT	K22170207	TYP E	5-
C 3065	CHIP CAP.	6pF	50V	CH	GRM40CH060D50PT	K22170207	TYP F	5-
C 3066	FILM CAP.	0.01	16V		ECHU1C103JB5	K57120007		
C 3067	CHIP CAP.	0.001uF	50V	B	GRM40B102M50PT	K22170805		
C 3068	CHIP CAP.	0.001uF	50V	B	GRM40B102M50PT	K22170805		
C 3069	CHIP CAP.	0.001uF	50V	B	GRM40B102M50PT	K22170805		
C 3070	CHIP CAP.	330pF	50V	CH	GRM40CH331J50PT	K22170247		
D 3001	DIODE				1SS272 TE85R	G2070048		
D 3002	DIODE				1SS226 TE85R	G2070003		
D 3003	DIODE				HSU277	G2070118		
D 3004	DIODE				HSU277	G2070118		

TX UNIT

REF.	DESCRIPTION	VALUE	WV	TOL.	MPGR'S DESIG	YAESU P/N	VERS.	LOT.
J 3001	CONNECTOR				SC25-04WL	P0090713		
J 3002	CONNECTOR				SC25-08WL	P0090715		
J 3003	CONNECTOR				BNC-RM-1 (W/O LUG)	P1090773A		
L 3001	CHIP COIL	0.022uH			LQN2A22NM	L1690002		
L 3002	CHIP COIL	0.022uH			LQN2A22NM	L1690002	TYP A	5-
L 3002	CHIP COIL	0.022uH			LQN2A22NM	L1690002	TYP C	5-
L 3002	CHIP COIL	0.01uH			LQN2A10NM	L1690001	TYP D	
L 3002	CHIP COIL	0.01uH			LQN2A10NM	L1690001	TYP E	5-
L 3002	CHIP COIL	0.01uH			LQN2A10NM	L1690001	TYP F	5-
L 3003	M. RFC	2.2uH			FLC32T-2R2K	L1690207		
L 3004	CHIP COIL	10uH			LQH3N100K02M00-	L1690087		
L 3005	CHIP COIL	0.01uH			LQN2A10NM	L1690001		
L 3006	CHIP COIL	0.022uH			LQN2A22NM	L1690002		
L 3007	M. RFC	2.2uH			FLC32T-2R2K	L1690207		
L 3008	M. RFC	2.2uH			FLC32T-2R2K	L1690207		
Q 3001	IC				NJM2904M-T2	G1091374		
Q 3002	TRANSISTOR				FMG2 T99	G3070015		
Q 3003	TRANSISTOR				2SC2812L6-TA	G3328127F		
Q 3004	IC				MC145190FER	G1091621		
Q 3005	TRANSISTOR				2SC3356-T2B R24	G3333567D		
Q 3006	TRANSISTOR				2SC3356-T2B R24	G3333567D		
Q 3007	TRANSISTOR				2SC3356-T2B R24	G3333567D		
Q 3008	IC				TA78L05F TE12R	G1091014		
Q 3009	IC				AN6541	G1091146		
Q 3010	TRANSISTOR				2SA1179M6-TA	G3111797F		
Q 3011	TRANSISTOR				2SC3357-T2	G3333577		
R 3001	CHIP RES.	27K	1/10W	5%	RMC1/10T 273J	J24205273		
R 3002	CHIP RES.	0	1/10W	5%	RMC1/10T 000J	J24205000		
R 3003	CHIP RES.	1.2K	1/10W	5%	RMC1/10T 122J	J24205122		
R 3004	CHIP RES.	1.2K	1/10W	5%	RMC1/10T 122J	J24205122		
R 3005	CHIP RES.	39K	1/10W	5%	RMC1/10T 393J	J24205393		
R 3006	CHIP RES.	12K	1/10W	5%	RMC1/10T 123J	J24205123		
R 3007	CHIP RES.	100K	1/10W	5%	RMC1/10T 104J	J24205104		
R 3008	CHIP RES.	560	1/10W	5%	RMC1/10T 561J	J24205561		
R 3009	CHIP RES.	100	1/10W	5%	RMC1/10T 101J	J24205101		
R 3010	CHIP RES.	3.9K	1/10W	5%	RMC1/10T 392J	J24205392		
R 3011	CHIP RES.	4.7K	1/10W	5%	RMC1/10T 472J	J24205472		
R 3012	CHIP RES.	4.7K	1/10W	5%	RMC1/10T 472J	J24205472		
R 3013	CHIP RES.	2.2K	1/10W	5%	RMC1/10T 222J	J24205222	TYP A	5-
R 3013	CHIP RES.	4.7K	1/10W	5%	RMC1/10T 472J	J24205472	TYP C	5-
R 3013	CHIP RES.	4.7K	1/10W	5%	RMC1/10T 472J	J24205472	TYP D	
R 3013	CHIP RES.	4.7K	1/10W	5%	RMC1/10T 472J	J24205472	TYP E	5-
R 3013	CHIP RES.	4.7K	1/10W	5%	RMC1/10T 472J	J24205472	TYP F	5-
R 3014	CHIP RES.	10K	1/10W	5%	RMC1/10T 103J	J24205103		
R 3015	CHIP RES.	0	1/10W	5%	RMC1/10T 000J	J24205000		
R 3016	CHIP RES.	22K	1/10W	5%	RMC1/10T 223J	J24205223		
R 3017	CHIP RES.	10K	1/10W	5%	RMC1/10T 103J	J24205103		
R 3018	CHIP RES.	47K	1/10W	5%	RMC1/10T 473J	J24205473		
R 3019	CHIP RES.	220K	1/10W	5%	RMC1/10T 224J	J24205224		

TX UNIT

REF.	DESCRIPTION	VALUE	WV	TOL.	MFGR'S DESIG	YAESU P/N	VERS.	LOT.
R 3020	CHIP RES.	470	1/10W	5%	RMC1/10T 471J	J24205471		
R 3021	CHIP RES.	220K	1/10W	5%	RMC1/10T 224J	J24205224		
R 3022	CHIP RES.	220K	1/10W	5%	RMC1/10T 224J	J24205224		
R 3023	CHIP RES.	100K	1/10W	5%	RMC1/10T 104J	J24205104		
R 3024	CHIP RES.	220K	1/10W	5%	RMC1/10T 224J	J24205224		
R 3026	CHIP RES.	12K	1/10W	5%	RMC1/10T 123J	J24205123		
R 3027	CHIP RES.	10	1/10W	5%	RMC1/10T 100J	J24205100		
R 3028	CHIP RES.	10K	1/10W	5%	RMC1/10T 103J	J24205103		
R 3029	CHIP RES.	680	1/10W	5%	RMC1/10T 681J	J24205681		
R 3031	CHIP RES.	0	1/10W	5%	RMC1/10T 000J	J24205000		
R 3032	CHIP RES.	2.2K	1/10W	5%	RMC1/10T 222J	J24205222		
R 3033	CHIP RES.	220	1/10W	5%	RMC1/10T 221J	J24205221		
R 3034	CHIP RES.	180	1/10W	5%	RMC1/10T 181J	J24205181		
R 3035	CHIP RES.	33	1/10W	5%	RMC1/10T 330J	J24205330		
R 3036	CHIP RES.	100	1/10W	5%	RMC1/10T 101J	J24205101		
R 3037	CHIP RES.	10	1/10W	5%	RMC1/10T 100J	J24205100		
R 3038	CHIP RES.	180	1/10W	5%	RMC1/10T 181J	J24205181		
R 3039	CHIP RES.	6.8K	1/10W	5%	RMC1/10T 682J	J24205682		
R 3040	CHIP RES.	12K	1/10W	5%	RMC1/10T 123J	J24205123		
R 3041	CHIP RES.	18	1/10W	5%	RMC1/10T 180J	J24205180		
R 3042	CHIP RES.	18	1/10W	5%	RMC1/10T 180J	J24205180		
R 3043	CHIP RES.	18	1/10W	5%	RMC1/10T 180J	J24205180		
R 3044	CHIP RES.	10K	1/10W	5%	RMC1/10T 103J	J24205103		
R 3045	CHIP RES.	2.2K	1/10W	5%	RMC1/10T 222J	J24205222		
R 3046	CHIP RES.	6.8K	1/10W	5%	RMC1/10T 682J	J24205682		
R 3048	CHIP RES.	100	1/10W	5%	RMC1/10T 101J	J24205101		
R 3050	CHIP RES.	330	1/10W	5%	RMC1/10T 331J	J24205331		
R 3051	CHIP RES.	1.8K	1/10W	5%	RMC1/10T 182J	J24205182		
R 3052	CHIP RES.	1.8K	1/10W	5%	RMC1/10T 182J	J24205182		
R 3053	CHIP RES.	2.7K	1/10W	5%	RMC1/10T 272J	J24205272		
R 3054	CHIP RES.	4.7K	1/10W	5%	RMC1/10T 472J	J24205472		
R 3055	CHIP RES.	220	1/10W	5%	RMC1/10T 221J	J24205221		
R 3056	CHIP RES.	47K	1/10W	5%	RMC1/10T 473J	J24205473		
R 3057	CHIP RES.	2.2K	1/10W	5%	RMC1/10T 222J	J24205222		
R 3058	CHIP RES.	12K	1/10W	5%	RMC1/10T 123J	J24205123		
R 3059	CHIP RES.	22	1/10W	5%	RMC1/10T 220J	J24205220		
R 3060	CHIP RES.	10	1/10W	5%	RMC1/10T 100J	J24205100		
R 3061	CHIP RES.	560	1/10W	5%	RMC1/10T 561J	J24205561		
R 3062	CHIP RES.	470	1/10W	5%	RMC1/10T 471J	J24205471		
R 3063	CHIP RES.	10	1/10W	5%	RMC1/10T 100J	J24205100		
R 3064	CHIP RES.	470	1/10W	5%	RMC1/10T 471J	J24205471		
R 3065	CHIP RES.	12	1/10W	5%	RMC1/10T 120J	J24205120		
R 3066	CHIP RES.	100	1/10W	5%	RMC1/10T 101J	J24205101		
R 3068	CHIP RES.	100	1/10W	5%	RMC1/10T 101J	J24205101		
VR3001	POT.	2K			EVN-DCAA03B23 2K	J50784202		
X 3001	XTAL				GFS-720(60206)	H9500210		
	SHIELD FRAME					R0147200		
	SHIELD CASE					R0519070A		
	SPECIAL NUT (4pcs)					R6068570		

TX UNIT