

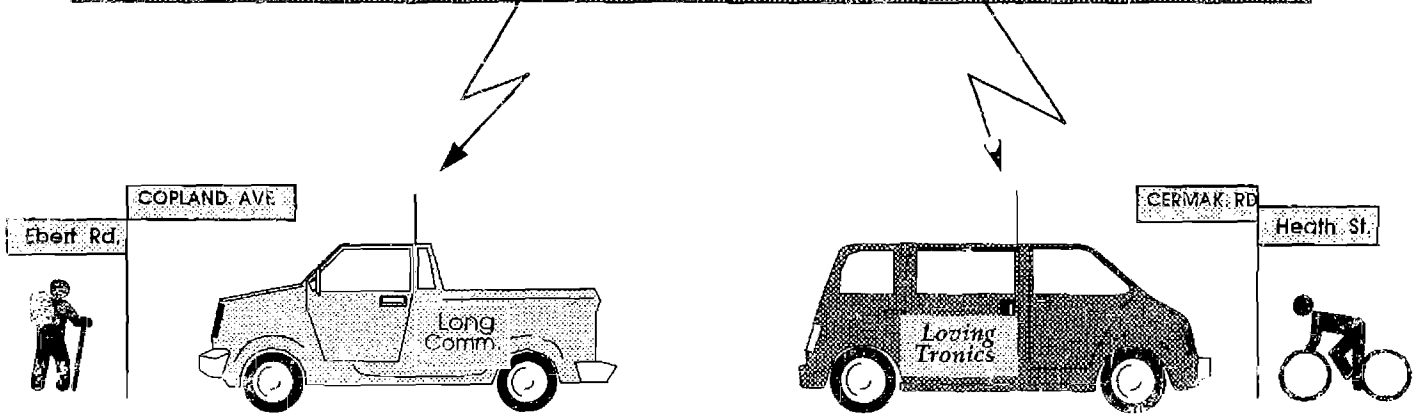

**MOTOROLA INC.**

# R\*I\*C\*K

## Repeater Interface Communications Kit

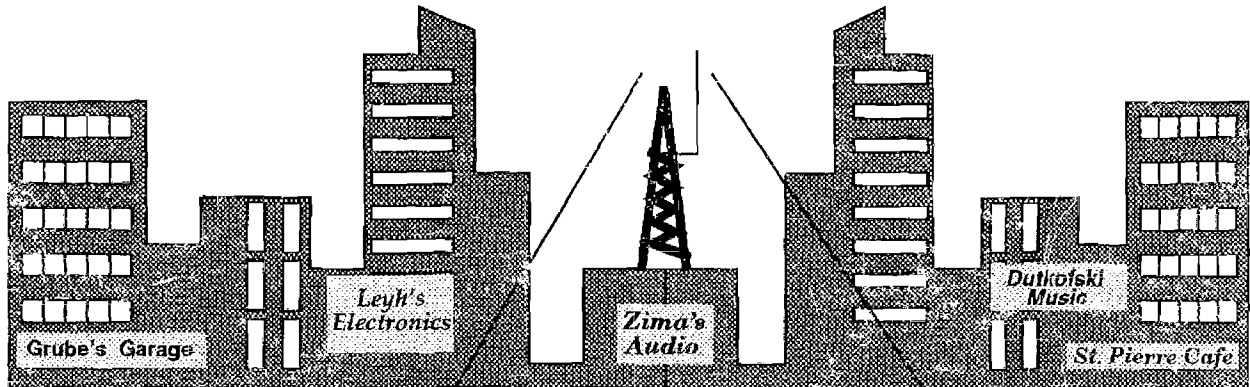
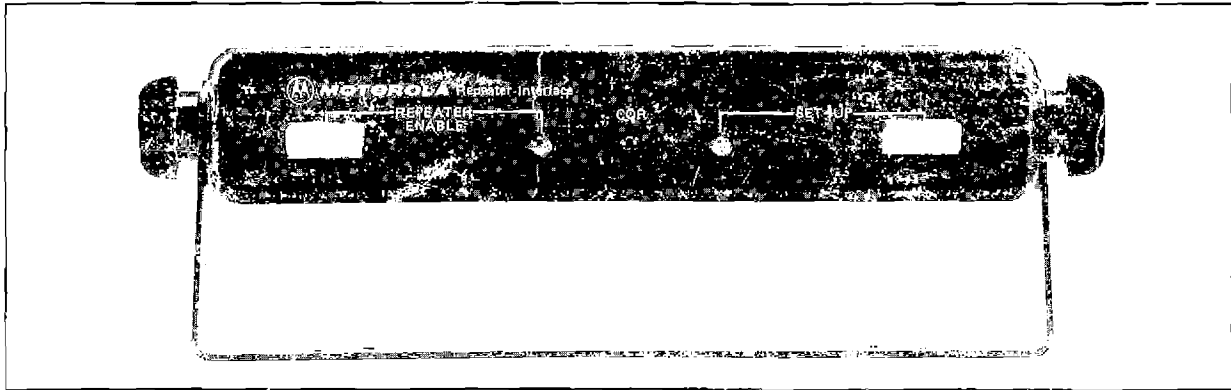

**Radius™**  
A DIVISION OF MOTOROLA INC.

6880901Z79-B

## TABLE OF CONTENTS

RADIO AND REPEATER COMPATIBILITY .....	ii
R*I*C*K (HLN3333) .....	1
Uses .....	1
Configurations .....	1
R*I*C*K Contents .....	1
REPEATER EXAMPLES .....	3
Cross Band, bi-directional .....	3
Single Band, unidirectional .....	9
R*I*C*K WORKSHEET .....	14
M400 INTERFACING WITH THE R*I*C*K .....	16
ADJUSTMENTS AND INTERCONNECTIONS .....	17
R*I*C*K Dip Switch S2 .....	17
R*I*C*K and Radios Interconnection .....	17
R*I*C*K Adjustments .....	17
Installation .....	18
DUPLEXERS, CABLES AND ANTENNA SPACING .....	19
Duplexers .....	19
Coaxial Cabling .....	19
Antenna Spacing .....	20
ACCESSORY COMPATIBILITY .....	22
Compatibility Chart .....	22
Radio Programming Screens .....	22
Modem Paging .....	23
Phone Patch .....	24
Public Address .....	25
Remote .....	26
RPB50 Interface .....	27
SETUP/KNOCKDOWN OPERATION .....	28
DIP SWITCH (S2) FUNCTIONS .....	29
THEORY OF OPERATION .....	30
TROUBLESHOOTING PROCEDURES .....	32
GLOSSARY .....	36
SCHEMATIC .....	38
CIRCUIT BOARD DIAGRAM .....	39
PARTS LISTS .....	40
LIGHTNING PROTECTION RECOMMENDATIONS .....	42
INDEX .....	44

# Radio and Repeater Configuration Compatibility

## Standard Configurations

	"Receiver" Radio			"Transmitter" Radio		
	M100	M200	M400	M100	M200	M400
Unidirectional Local Setup/ Knockdown	NO	YES	NO	YES	YES	YES
Unidirectional Remote/Local Setup/Knockdown	NO	YES	NO	YES	YES	YES
Bi-directional Local Setup/ Knockdown	NO	YES	NO	NO	YES	NO
Bi-directional Remote/Local Setup/Knockdown	NO	YES	NO	NO	YES	NO

The M200 series radios include the newer models M208 and M216 or the older models M206 and M214 with either the B308 option for the Local Setup/Knockdown operation or the B833 option for the Remote/Local Setup/Knockdown operation.

## Very Limited Capability ("VLC") Configuration

	"Receiver" Radio			"Transmitter" Radio		
	M100	M200	M400	M100	M200	M400
Unidirectional Local Setup/ Knockdown	YES	YES	NO	YES	YES	YES

The "VLC" configuration requires radios with logic boards date coded 8937 and later, which have been shipping since late 1989. The date codes are ink-stamped on the top surface of the PC board.

See "R\*I\*C\*K, Radio and Associated Hardware" section of this manual for further explanation of the "VLC" repeater.

## **R\*I\*C\*K (HLN3333) Repeater Interface Communications Kit**

The Radius Repeater Interface Communications Kit, the R\*I\*C\*K, connects between two Radius mobile radios to construct an **intermittent** duty radio repeater. The repeater is referred to as a Radius "2-mobile" repeater.

### **Uses**

Some of the possible uses for the Radius "2-mobile" repeater include:

- MOBILE REPEATER
- MOBILE PAC\*RT "LIKE" REPEATER
- SUITCASE REPEATER
- PORTABLE SITE REPEATER
- "MOUNTAIN TOP" (lookout) REPEATER
- FIXED (rural) SITE REPEATER
- FIXED (base) REPEATER
- SHORT TERM, SUBSTITUTE RT REPEATER

The terms of the FCC license for a particular operator will determine the frequencies, output power and antenna heights for a given situation. Part 90 of the FCC Rules and Regulations must be consulted before a Radius "2-mobile" repeater is activated.

### **Configurations**

Possible configurations for a Radius "2-mobile Repeater" are:

- SINGLE BAND RT (unidirectional) REPEATER
- CROSSBAND RT (unidirectional) REPEATER
- SINGLE BAND, BI-DIRECTIONAL REPEATER
- CROSSBAND, BI-DIRECTIONAL REPEATER

### **R\*I\*C\*K Contents**

The HLN3333 R\*I\*C\*K consists of the following individual kits:

HLN9809	R*I*C*K Board
HLN9822	R*I*C*K Hardware
HKN9837	R*I*C*K Intercabling
HLN9839	Mounting Hardware

### **References to the M200 Series Radios**

References to the M200 series radios include the newer models M208 and M216 or the older models M206 and M214 with either the B308 option for the Local Setup/Knockdown operation or the B833 option for the Remote/Local Setup/Knockdown operation.

## **WARNING**

The Radius "2-mobile" repeater is an **INTERMITTENT** duty repeater only. Extended periods of transmitter keying will result in a steady decrease of the output power. No harm to the radio will occur.

## **WARNING**

Before placing a Radius "2-mobile" repeater in service, Part 90 FCC Rules and Regulations must be consulted. The legal limits for frequency use, power output, coded squelch and antenna height must be determined for a given service of operation.

## R\*I\*C\*K FRONT PANEL

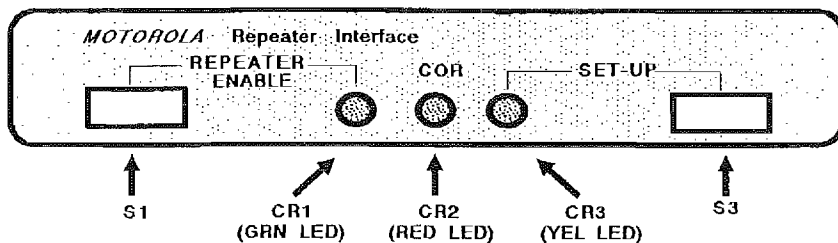

## R\*I\*C\*K BACK PANEL

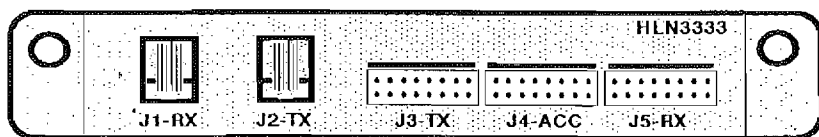

## R\*I\*C\*K REPEATER CONFIGURATIONS

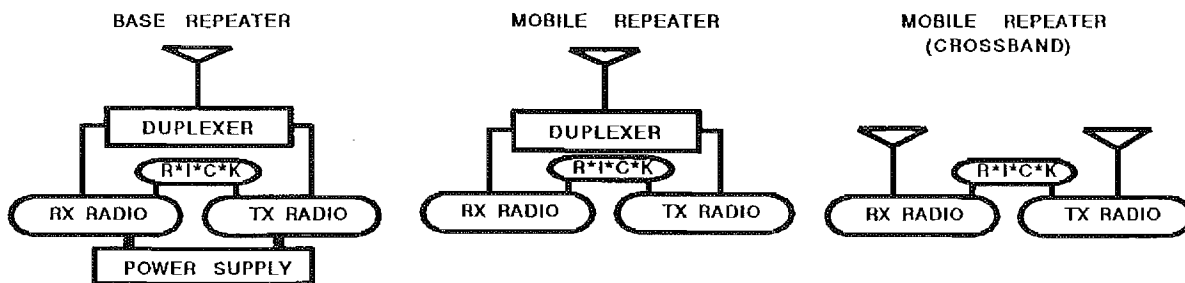

## CAUTION

INSERT CONNECTORS  
WITH LOCKING TABS  
UP!

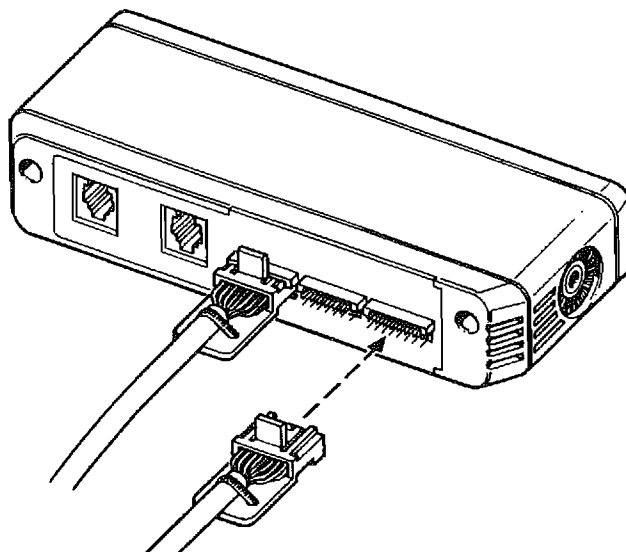
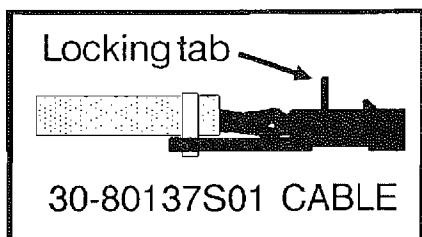

## Repeater Examples

The two examples that follow will probably cover the majority of the applications for the R\*I\*C\*K. The step by step outlines and the printouts from the Radio Service Software (RSS) should allow the service technician to easily get a Radius "2-mobile" repeater "up and running".

Two configurations are discussed in this "example" section:

1. a cross band, bi-directional repeater
2. a single band, unidirectional repeater

Refer to the "Glossary" at the end of this manual for the definitions of any unfamiliar terms.

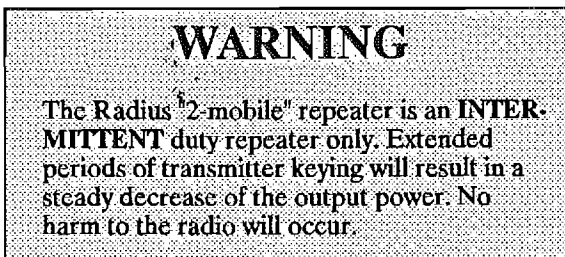

It is assumed that a Radio Interface Box (RIB) is connected to an IBM PC or equivalent and the RSS "MAIN MENU" is on the screen. If there are any questions concerning the RSS during the course of programming the radios, please refer to the "Radio Service Software Manual for Radius M100/M200 Mobile Radios", Motorola P/N 6880900Z20. The "ENTER" key on your keyboard may be marked with an arrow.

### Cross Band, Bi-Directional Repeater

The following section describes the programming information for the radios used to assemble a cross band, bi-directional repeater. Each radio will receive and transmit on a single frequency in its respective band of operation. The configuration uses two Radius M200 series radios.

The particular application is similar to a PAC\*RT system. A Fire Department desires local coverage at emergency scenes. The normal dispatch frequency for the Fire Department is 154.310 MHz (high-band VHF). The Department wishes to use 453.9875 MHz for the local coverage by UHF portable radios. The Time Out Timers of both of the radios will be set for 60 seconds. No signaling systems will be programmed into the radios. Normal receiver audio and transmitter microphone audio will be used for both radios.

A) **The "receiver" radio:** Let's define the "receiver" radio as the normal mobile radio used in the

emergency squad. The mobile radio is a 40 Watt VHF M216. Mode 1 will be programmed to receive and transmit on 154.310 MHz. Carrier squelch (CSQ) operation should be programmed to allow monitoring the highband frequency from the UHF portable radios.

- 1) Connect the radio to the RIB and a suitable power supply. Turn on the power supply.
- 2) Press the F3 "GET SAVE" key to bring up the "GET / SAVE MENU".
- 3) Press the F2 "READ CODEPLUG" key.
- 4) When the computer has finished reading the codeplug, press the F10 "EXIT" key.
- 5) Press the F4 "CHANGE VIEW" key to bring up the "CHANGE/VIEW CODEPLUG MENU".
- 6) Press the F2 "RADIO WIDE" key.
- 7) Key in the desired "TIME OUT TIMER" (time in seconds (060 for our example). Press the "ENTER" key.
- 8) Repeatedly press the "TAB" key until the "ACC. EXTERNAL" area is highlighted.
- 9) Repeatedly press the up arrow key to scroll through the accessories until "GENERAL I/O" appears. Press the "ENTER" key.
- 10) Press the F9 "OTHER ACCESSORY" key to view the "ACCESSORY CONNECTOR CONFIGURATION" screen.
- 11) It is a good idea to inhibit the radio for a short time after power-up; use the down arrow key to scroll the values in the "POWER-UP DELAY:" highlight until "4.301" appears. Press the "ENTER" key.
- 12) Repeatedly press the "TAB" key until the "FUNCTION #" column for "PIN NUMBER" 8 is highlighted.
- 13) Press the up arrow key to set the "FUNCTION #" to "01". Verify that a "NULL" function with an "OUTPUT" direction is present. Press the "ENTER" key. If a "LOW" active level description is present proceed to step 14. If the active level is "HIGH", then press the "TAB" key until the "HIGH" is highlighted under the "ACTIVE LEVEL" column. Press the up arrow to toggle to the "LOW" condition. Press the "ENTER" key.
- 14) Repeatedly press the "TAB" key until the "FUNCTION #" for "PIN NUMBER" 14 is highlighted.

- 15) Repeatedly press the up arrow key to set the "FUNCTION #" to "05". Verify that the "PL/DPL & CSQ Det" function with an "OUTPUT" direction is present. Press the "ENTER" key. If the "LOW" active level description is present then proceed to step 16. If the active level is "HIGH", then press the "TAB" key until the "HIGH" is highlighted under the "ACTIVE LEVEL" column. Press the up arrow to toggle to the "LOW" condition. Press the "ENTER" key.
- 16) Press the F10 key **twice** to return to the "CHANGE/ VIEW CODEPLUG MENU".
- 17) Press the F5 "MODE" key to move to the "MODE CONFIGURATION" screen.
- 18) Press the "TAB" key to highlight the "Rx FREQUENCY" area. Key in the receive frequency (154.3100 for this example). Press the "ENTER" key.
- 19) Key in the transmit frequency (154.3100 for this example). Press the "ENTER" key.
- 20) Since there are no coded squelch tones/codes or signaling systems being used at this time, verify that the "RX SQUELCH Type" is "Carrier". If "Carrier" is not present in the highlighted area, repeatedly press the up arrow until "Carrier" appears. Press the "ENTER" key.
- 21) Press the F10 key **twice** to return to the "MAIN MENU" screen. Verify that you have the "MAIN MENU" screen.
- 22) Press the F3 "GET SAVE" key to bring up the "GET / SAVE MENU".
- 23) Press the F8 "PROGRAM CODEPLUG" key to program the radio. You will be prompted to verify that you want to program the radio; press F2 ("CONTINUE") to confirm.
- 24) Press the F7 "SAVE FILE" key to save the codeplug data to a disk file. If the radio has not been previously programmed, you will be prompted to "CONTINUE" by pressing the F2 key. You will be asked to supply a "Customer ID:" such as HP Fire Dept.
- 25) Press F8 to save the data to the disk.
- 26) Turn off the radio and disconnect the power cable.
- 27) Remove the four (4) screws that secure the top and bottom covers. Loosen the two (2) front panel screws sufficiently to allow removing the bottom cover.
- 28) Move jumper block JU551 from the "A" position to the "B" position. (JU551 is near the heatsink support bar.)
- 29) Replace the bottom cover. Tighten the front panel screws. Replace the four (4) cover screws and tighten.
  - B) **The "transmitter" radio:** The "transmitter" radio is a 2 Watt LPI UHF M216 that operates on 453.9875 MHz with tone coded squelch (PL 1A-103.5 Hz).
    - 1) Connect the radio to the RIB and a suitable power supply. Turn on the power supply.
    - 2) Press the F3 "GET SAVE" key to bring up the "GET / SAVE MENU".
    - 3) Press the F2 "READ CODEPLUG" key.
    - 4) When the computer has finished reading the codeplug, press the F10 "EXIT" key.
    - 5) Press the F4 "CHANGE VIEW" key to bring up the "CHANGE/VIEW CODEPLUG MENU".
    - 6) Press the F2 "RADIO WIDE" key.
    - 7) Key in the desired "TIME OUT TIMER" time in seconds (060 for our example). Press the "ENTER" key.
    - 8) Repeatedly press the "TAB" key until the "ACC. EXTERNAL" area is highlighted.
    - 9) Repeatedly press the up arrow key to scroll through the accessories until "GENERAL I/O" appears. Press the "ENTER" key.
    - 10) Press the F9 "OTHER ACCESSORY" key to view the "ACCESSORY CONNECTOR CONFIGURATION" screen.
    - 11) Let's inhibit the radio for a short time after power-up; use the down arrow key to scroll the values in the "POWER-UP DELAY:" highlight until "4.301" appears. Press the "ENTER" key.
    - 12) Repeatedly press the "TAB" key until the "FUNCTION #" for "PIN NUMBER" 8 is highlighted.
    - 13) Repeatedly press the up arrow key to set the "FUNCTION #" to "05". Verify that the "PL/DPL & CSQ Det" function with an "OUTPUT" direction is present. Press the "ENTER" key. If the "LOW" active level description is present then proceed to step 14. If the active level is "HIGH", then press the "TAB" key until the "HIGH" is highlighted under the "ACTIVE

LEVEL" column. Press the up arrow to toggle to the "LOW" condition. Press the "ENTER" key.

- 14) Repeatedly press the "TAB" key until the "FUNCTION #" column for "PIN NUMBER" 14 is highlighted.
  - 15) Press the up arrow key to set the "FUNCTION #" to "01". Verify that a "NULL" function with an "OUTPUT" direction is present. Press the "ENTER" key. If a "LOW" active level description is present proceed to step 16. If the active level is "HIGH", then press the "TAB" key until the "HIGH" is highlighted under the "ACTIVE LEVEL" column. Press the up arrow to toggle to the "LOW" condition. Press the "ENTER" key.
  - 16) Press the F10 "EXIT" key twice to return to the "CHANGE/VIEW CODEPLUG MENU".
  - 17) Press the F5 "MODE" key to move to the "MODE CONFIGURATION" screen.
  - 18) Press the "TAB" key to highlight the "Rx FREQUENCY" area. Key in the receive frequency (453.9875 for this example). Press the "ENTER" key.
  - 19) Key in the transmit frequency (453.9875 for this example). Press the "ENTER" key.
  - 20) Press the up arrow key to scroll the "Rx SQUELCH Type" to "TPL". Press the "ENTER" key.
  - 21) Key in the TPL tone frequency (103.5 or 1A for this example). Press the "ENTER" key.
- If, as in our example, the transmit TPL code is the same as the receive TPL code, then proceed to step 23.
- 22) If the transmit TPL code is different from the receive TPL code, then press the "TAB" key to highlight the "Tx SQUELCH Code" area and key in the proper TPL code. Press the "ENTER" key.
  - 23) Repeatedly press the F10 key to return to the "MAIN MENU" screen. Verify that you have the "MAIN MENU".
  - 24) Press the F3 "GET SAVE" key to bring up the "GET / SAVE MENU".
  - 25) Press the F8 "PROGRAM CODEPLUG" key to program the radio. You will be prompted to verify that you want to program the radio; press

F2 ("CONTINUE") to confirm that you do want to program the radio.

- 26) Press the F7 "SAVE FILE" key to save the codeplug data to a disk file. If the radio has not been previously programmed, you will be prompted to "CONTINUE" by pressing the F2 key. You will be asked to supply a "Customer ID:" such as HP Fire Dept.
- 27) Press F8 to save the data to the disk.
- 28) Turn off the radio and disconnect the power cable.
- 29) Remove the four (4) screws that secure the top and bottom covers. Loosen the two (2) front panel screws sufficiently to allow removing the bottom cover.
- 30) Move jumper block JU551 from the "A" position to the "B" position. (JU551 is located near the heatsink.)
- 31) Replace the bottom cover. Tighten the front panel screws. Replace the four (4) cover screws and tighten.

#### C) R\*I\*C\*K Dip Switch (S2) Settings:

- 1) The repeater is bi-directional; turn S2-1 "ON".
- 2) The pin 14 signal of the "receiver" radio will key the "transmitter" radio; turn S2-2 "ON" and S2-3 "OFF".
- 3) There isn't any remote control to used with the repeater; turn S2-4 "OFF".
- 4) We have decided to use normal receiver audios from the radios; turn S2-5 "OFF", S2-6 "ON", S2-8 "ON" and S2-9 "OFF".
- 5) We will use the "COR" signal from the "receiver" radio; turn S2-7 "OFF".
- 6) The bi-directional repeater requires the shortest dropout delay; turn S2-10 and S2-11 "ON".
- 7) Our configuration is standard; turn S2-12 "OFF".

After setting all of the positions, dip switch S2 should look like the drawing on the following page.

D) **ADJUSTMENTS:** Continue to the sections of this manual titled "R\*I\*C\*K, Radio and Associated Hardware" and "R\*I\*C\*K Adjustments" for the completion of the setup process.



ON POSITION →

OFF POSITION →

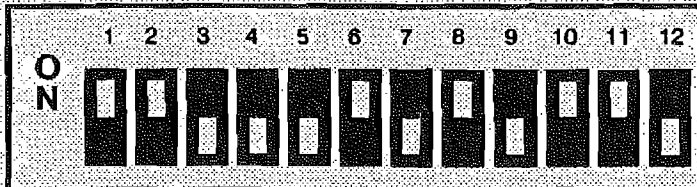

NOTE: WHITE PORTION INDICATES SWITCH POSITION

**S2 SETTINGS: BIDIRECTIONAL REPEATER**

# CROSS BAND, BI-DIRECTIONAL REPEATER "Receiver" Radio RSS Configuration

```

MOTOROLA Radio Service Software                                03 Dec 90
Radius M214                                                    13:50
Version R07.10.00
-----
Model:    D43LRA7PA5AK                      Coded Squelch
Serial:   778FNQ3693                        High Band
Software: 009                               40 W
-----
CHANGE/VIEW:RADIO WIDE                                SCREEN PRINT UTILITY
-----

                                RADIO WIDE CONFIGURATION
                                -----

MODEL INFORMATION                                           OPTIONS
D43LRA7PA5AK.....40 WATT                                TIME OUT TIMER.....060
HIGH BAND.....146.0 - 174.0 MHz                         PRIORITY 2 SCAN MODE.....Off
SQUELCH.....Coded                                       PRIORITY SAMPLING RATE...FAST
CONVENTIONAL MODES.....3                                HANDSET.....N
SERIAL NUMBER.....778FNQ3693                            SCAN TALK BACK.....Y
                                                         EMERGENCY ALARM.....NONE

                                                         ACC. INTERNAL.....NONE
                                                         ACC. EXTERNAL...  GENERAL I/O
                                                         ACC. CUSTOM.....Y
    
```

```

MOTOROLA Radio Service Software                                03 Dec 90
Radius M214                                                    13:50
Version R07.10.00
-----
Model:    D43LRA7PA5AK                      Coded Squelch
Serial:   778FNQ3693                        High Band
Software: 009                               40 W
-----
CHANGE/VIEW:RADIO WIDE:CONN CON                        SCREEN PRINT UTILITY
-----

                                ACCESSORY CONNECTOR CONFIGURATION
                                -----

INTERNAL ACCESSORY: NONE EXTERNAL ACCESSORY:              GENERAL I/O      CUSTOM: YES

  PIN      FUNCTION      DATA      DEBOUNCE      ACTIVE
  NUMBER   # DESCRIPTION   DIRECTION  OUTPUT        LEVEL
  -----   -
  4         03 External Alarm  OUTPUT     NO            HIGH
  6         00 NULL           INPUT      NO            LOW
  8         01 NULL           OUTPUT     NO            LOW
  9         02 Emergency Switch  INPUT     YES           HIGH
  12        00 NULL           INPUT      NO            LOW
  14        05 PL/DPL & CSQ Det  OUTPUT     NO            LOW

POWER-UP DELAY: 4.301 SEC
    
```

```

MOTOROLA Radio Service Software                                03 Dec 90
Radius M214                                                    13:50
Version R07.10.00
-----
Model:    D43LRA7PA5AK                      Coded Squelch
Serial:   778FNQ3693                        High Band
Software: 009                               40 W
-----
CHANGE/VIEW:MODE                                        SCREEN PRINT UTILITY
-----

                                MODE CONFIGURATION
                                -----

MODE 001
NAME.....01                               Busy Channel Lockout...N
TYPE.....Conventional
RX FREQUENCY.....154.31000                PHONE Signaling System...00
TX FREQUENCY.....154.31000                PHONE Signaling Name...NONE

Rx SQUELCH Type.....Carrier               Rx Signaling System.....00
                                           Rx Signaling Name.....NONE

Tx SQUELCH Type.....Carrier               Tx Signaling System.....00
                                           Tx Signaling Name.....NONE
    
```

# CROSS BAND, BI-DIRECTIONAL REPEATER "Transmitter" Radio RSS Configuration

```

MOTOROLA Radio Service Software                                03 Dec 90
Radius M214                                                    13:48
Version R07.10.00
-----
Model:   D04LRA7PA5AK                                         Coded Squelch
Serial:  778FNU1750                                           UHF
Software: 009                                                  2 W
-----
CHANGE/VIEW: RADIO WIDE                                       SCREEN PRINT UTILITY
-----
                        RADIO WIDE CONFIGURATION
                        -----
MODEL INFORMATION                                           OPTIONS
D04LRA7PA5AK..... 2 WATT                                     TIME OUT TIMER.....060
UHF BAND ..... 449.0 - 470.0 MHz                             PRIORITY 2 SCAN MODE.....Off
SQUELCH ..... Coded                                          PRIORITY SAMPLING RATE.....FAST
CONVENTIONAL MODES.....16                                     HANDSET.....N
SERIAL NUMBER.....778FNU1750                                  SCAN TALK BACK.....Y
                                                                EMERGENCY ALARM.....NONE
                                                                ACC. INTERNAL.....NONE
                                                                ACC. EXTERNAL.. GENERAL I/O
                                                                ACC. CUSTOM.....Y
  
```

```

MOTOROLA Radio Service Software                                03 Dec 90
Radius M214                                                    14:38
Version R07.10.00
-----
Model:   D04LRA7PA5AK                                         Coded Squelch
Serial:  778FNU1750                                           UHF
Software: 009                                                  2 W
-----
CHANGE/VIEW: RADIO WIDE:CONN CON                             SCREEN PRINT UTILITY
-----
                        ACCESSORY CONNECTOR CONFIGURATION
                        -----
INTERNAL ACCESSORY: NONE EXTERNAL ACCESSORY: GENERAL I/O CUSTOM: YES

  PIN      FUNCTION      DATA      DEBOUNCE      ACTIVE
  NUMBER   # DESCRIPTION   DIRECTION
  -----
  4         03 External Alarm  OUTPUT     NO            HIGH
  6         00 NULL           INPUT      NO            LOW
  8         05 PL/DPL & CSQ Det  OUTPUT     NO            LOW
  9         02 Emergency Switch  INPUT      YES           HIGH
  12        00 NULL           INPUT      NO            LOW
  14        01 NULL           OUTPUT     NO            LOW

POWER-UP DELAY: 4.301 SEC
  
```

```

MOTOROLA Radio Service Software                                03 Dec 90
Radius M214                                                    13:55
Version R07.10.00
-----
Model:   D04LRA7PA5AK                                         Coded Squelch
Serial:  778FNU1750                                           UHF
Software: 009                                                  2 W
-----
CHANGE/VIEW: MODE                                           SCREEN PRINT UTILITY
-----
                        MODE CONFIGURATION
                        -----
MODE 001
NAME.....01 Busy Channel Lockout...N
TYPE.....Conventional
Rx FREQUENCY.....453.98750 PHONE Signaling System...00
Tx FREQUENCY.....453.98750 PHONE Signaling Name...NONE

Rx SQUELCH Type.....TPL Rx Signaling System.....00
Rx SQUELCH Code.....103.5 1A Rx Signaling Name.....NONE

Tx SQUELCH Type.....TPL Tx Signaling System.....00
Tx SQUELCH Code.....103.5 1A Tx Signaling Name.....NONE
  
```

## Single Band, Unidirectional Repeater

The following section describes the programming information for the radios used to assemble a single band, unidirectional repeater. The configuration uses one Radius M200 series radio for the "receiver" radio and one Radius M100 radio for the "transmitter" radio. (A Radius M200 series radio may be used as the "transmitter" radio instead of the M100; refer to subsection E) M200 series "transmitter" radio for programming and setup details.)

During a severe spring storm, lightning has damaged part of a repeater. The application for the Radius "2-mobile" repeater is a temporary repeater to "fill in" while the main repeater is being repaired. The frequencies for the repeater are receive on 456.550 MHz with tone coded squelch of 167.9 Hz (PL 6Z) and transmit on 451.550 MHz with tone coded squelch of 103.5 Hz (PL 1A). The Time Out Timer will be set for 60 seconds. The repeater drop out delay (or hang time) will be set at 1.5 seconds. No signaling systems will be programmed into the radios. Normal receiver audio and transmitter microphone audio will be used for both radios.

A) **The "receiver" radio:** The "receiver" radio is a Radius 2 Watt LPI UHF M216. Mode 1 will be programmed to receive and transmit on the receive frequency of 456.550 MHz with PL 6Z.

- 1) Connect the radio to the RIB and a suitable power supply. Turn on the power supply.
- 2) Press the F3 "GET SAVE" key to bring up the "GET / SAVE MENU".
- 3) Press the F2 "READ CODEPLUG" key.
- 4) When the computer has finished reading the codeplug, press the F10 "EXIT" key.
- 5) Press the F4 "CHANGE VIEW" key to bring up the "CHANGE/VIEW CODEPLUG MENU".
- 6) Press the F2 "RADIO WIDE" key.
- 7) Key in the desired "TIME OUT TIMER" time in seconds (060 for our example). Press the "ENTER" key.
- 8) Repeatedly press the "TAB" key until the "ACC. EXTERNAL" area is highlighted.
- 9) Repeatedly press the up arrow key to scroll through the accessories until "GENERAL I/O" appears. Press the "ENTER" key.
- 10) Press the F9 "OTHER ACCESSORY" key to view the "ACCESSORY CONNECTOR CONFIGURATION" screen.
- 11) It is suggested to inhibit the radio for a short time after power-up; use the down arrow key to scroll the values in the "POWER-UP DELAY:" highlight until "4.301" appears. Press the "ENTER" key.
- 12) Repeatedly press the "TAB" key until the "FUNCTION #" column for "PIN NUMBER" 8 is highlighted.
- 13) Repeatedly press the up arrow key to set the "FUNCTION #" to "05". Verify that the "PL/DPL & CSQ Det" function with an "OUTPUT" direction is present. Press the "ENTER" key. If the "LOW" active level description is present then proceed to step 14. If the active level is "HIGH", then press the "TAB" key until the "HIGH" is highlighted under the "ACTIVE LEVEL" column. Press the up arrow to toggle to the "LOW" condition. Press the "ENTER" key.
- 14) Repeatedly press the "TAB" key until the "FUNCTION #" for "PIN NUMBER" 14 is highlighted.
- 15) Press the up arrow key to set the "FUNCTION #" to "01". Verify that a "NULL" function with an "OUTPUT" direction is present. Press the "ENTER" key. If a "LOW" active level description is present proceed to step 16. If the active level is "HIGH", then press the "TAB" key until the "HIGH" is highlighted under the "ACTIVE LEVEL" column. Press the up arrow to toggle to the "LOW" condition. Press the "ENTER" key.
- 16) Press the F10 "EXIT" key twice to return to the "CHANGE/ VIEW CODEPLUG MENU".
- 17) Press the F5 "MODE" key to move to the "MODE CONFIGURATION" screen.
- 18) Press the "TAB" key to highlight the "Rx FREQUENCY" area. Key in the receive frequency (456.5500 for this example). Press the "ENTER" key.
- 19) Key in either a transmit frequency (456.5500 for this example) or BLANK. Press the "ENTER" key.
- 20) Press the up arrow key to scroll the "Rx SQUELCH Type" to "TPL". Press the "ENTER" key.
- 21) Key in the TPL tone frequency (167.9 or 6Z for this example). Press the "ENTER" key.
- 22) Press the F10 key twice to return to the "MAIN MENU" screen. Verify that you have the "MAIN MENU".

- 23) Press the F3 "GET SAVE" key to bring up the "GET / SAVE MENU".
  - 24) Press the F8 "PROGRAM CODEPLUG" key to program the radio. You will be prompted to verify that you want to program the radio; press F2 ("CONTINUE") to confirm.
  - 25) Press the F7 "SAVE FILE" key to save the codeplug data to a disk file. If the radio has not been previously archived, you will be prompted to "CONTINUE" by pressing the F2 key. You will be asked to supply a "Customer ID:" such as Emer Rptr RX.
  - 26) Press F8 to save the data to the disk.
  - 27) Turn off the radio and disconnect the power cable.
  - 28) Remove the four (4) screws that secure the top and bottom covers to the radio. Loosen the two (2) front panel screws sufficiently to allow removing the bottom cover.
  - 29) Move jumper block JU551 from the "A" position to the "B" position. (JU551 is located near the support bar for the heatsink.)
  - 30) Replace the bottom cover. Tighten the front panel screws. Replace the four (4) cover screws and tighten.
- B) The "transmitter" radio:** The "transmitter" radio is a Radius 35 Watt UHF M100. The operating frequency is 451.550 MHz with PL 1A.
- 1) Connect the radio to the RIB and a suitable power supply. Turn on the power supply.
  - 2) Press the F3 "GET SAVE" key to bring up the "GET / SAVE MENU".
  - 3) Press the F2 "READ CODEPLUG" key.
  - 4) When the computer has finished reading the codeplug, press the F10 "EXIT" key.
  - 5) Press the F4 "CHANGE VIEW" key to bring up the "CHANGE/VIEW CODEPLUG MENU".
  - 6) Press the F2 "RADIO WIDE" key.
  - 7) Key in the desired "TIME OUT TIMER" time in seconds (060 for our example). Press the "ENTER" key.
  - 8) Press the F10 key to return to the "CHANGE/VIEW CODEPLUG MENU".
  - 9) Press the F5 "MODE" key to move to the "MODE CONFIGURATION" screen.
- 10) Press the "TAB" key to highlight the "Rx FREQUENCY" area. Key in the receive frequency (451.5500 for this example). Press the "ENTER" key.
  - 11) Key in the transmit frequency (451.5500 for this example). Press the "ENTER" key.
  - 12) Press the up arrow key to scroll the "Rx SQUELCH Type" to "TPL". Press the "ENTER" key.
  - 13) Key in the TPL tone frequency (103.5 or 1A for this example). Press the "ENTER" key.
  - 14) Press the F10 "EXIT" key **twice** to return to the "MAIN MENU".
  - 15) Press the F3 "GET SAVE" key to bring up the "GET / SAVE MENU".
  - 16) Press the F8 "PROGRAM CODEPLUG" key to program the radio. You will be prompted to verify that you want to program the radio; press F2 ("CONTINUE") to confirm.
  - 17) Press the F7 "SAVE FILE" key to save the codeplug data to a disk file. If the radio has not been previously programmed, you will be prompted to "CONTINUE" by pressing the F2 key. You will be asked to supply a "Customer ID:" such as Emer Rptr TX.
  - 18) Press F8 to save the data to the disk.
  - 19) Turn off the radio and disconnect the power cable.
- C) R\*I\*C\*K Dip Switch (S2) Settings:**
- 1) The repeater is unidirectional; turn S2-1 "OFF".
  - 2) The "receiver" radio will key the "transmitter" radio with the pin 8 signal; turn S2-2 "OFF" and S2-3 "ON".
  - 3) There isn't any remote control to used with the repeater; turn S2-4 "OFF".
  - 4) We have decided to use normal receiver audio from the receiver; turn S2-5 "OFF", S2-6 "ON", S2-8 "OFF" and S2-9 "OFF".
  - 5) We will use the "COR" signal from the "receiver" radio; turn S2-7 "OFF".
  - 6) We desired a 1.5 second drop out delay to unkey the "transmitter" radio; turn S2-10 "ON" and S2-11 "OFF".
  - 7) Our configuration is standard; turn S2-12 "OFF".

After setting all of the positions, dip switch S2 should look like the drawing below.

D) **Adjustments:** Continue to the sections of this manual titled "R\*I\*C\*K, Radio and Associated Hardware" and "R\*I\*C\*K Adjustments" for the completion of the setup process.

E) **M200 series "transmitter" radio:** If a microphone is to be used with the "transmitter" radio in a unidirectional repeater then a Radius M200 series radio must be used. The I/O lines must be programmed. The following steps continue the setup of the M200 radios as the "transmitter" radio for those cases in which no external accessory will be attached to the R\*I\*C\*K. If an external accessory will be used with the R\*I\*C\*K then refer to the "ACCESSORY COMPATIBILITY" section of this manual (see Table of Contents).

- 1) Follow steps 1 through 13 described in B) **The "transmitter" radio.** After completing step 13, you should be in the "MODE CONFIGURATION" screen.
- 2) Press the F10 "EXIT" key to return to the "CHANGE/VIEW CODEPLUG MENU".
- 3) Press the F2 "RADIO WIDE" key.
- 4) Repeatedly press the "TAB" key until the "ACC. EXTERNAL" area is highlighted.
- 5) Use the up arrow key until the "GENERAL I/O" appears in the highlight. Press the "ENTER" key.
- 6) Press the F9 "OTHER ACCESSORY" key to view the "ACCESSORY CONNECTOR CONFIGURATION" screen.
- 7) It is suggested to inhibit the radio for a short

time after power-up; use the down arrow key to scroll the values in the "POWER-UP DELAY:" highlight until "4.301" appears. Press the "ENTER" key.

- 8) Repeatedly press the TAB key until the "FUNCTION #" for "PIN NUMBER" 8 is highlighted.
- 9) Repeatedly press the up arrow key to set the "FUNCTION #" to "01". Verify that a "NULL" function with an "OUTPUT" direction is present. Press the "ENTER" key. If a "LOW" active level description is present proceed to step 10. If the active level is "HIGH", then press the "TAB" key until the "HIGH" is highlighted under the "ACTIVE LEVEL" column. Press the up arrow to toggle to the "LOW" condition. Press the "ENTER" key.
- 10) Repeatedly press the TAB key until the "FUNCTION #" for "PIN NUMBER" 14 is highlighted.
- 11) Repeatedly press the up arrow key to set the "FUNCTION #" to "01". Verify that a "NULL" function with an "OUTPUT" direction is present. Press the "ENTER" key. If a "LOW" active level description is present proceed to step 12. If the active level is "HIGH", then press the "TAB" key until the "HIGH" is highlighted under the "ACTIVE LEVEL" column. Press the up arrow to toggle to the "LOW" condition. Press the "ENTER" key.
- 12) Press the F10 "EXIT" key to return to the "RADIO WIDE" screen.
- 13) To program the "transmitter" radio, return to subsection B) **The "transmitter" radio.** Complete the remaining steps 14 through 19 in subsection B) then continue to subsections C) **R\*I\*C\*K Dip Switch (S2) Settings** and D) **Adjustments.**

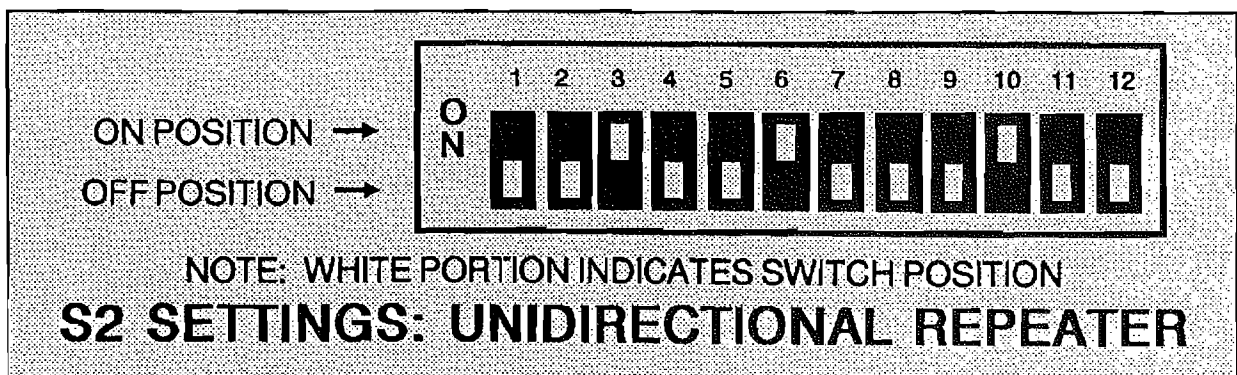

# SINGLE BAND, UNIDIRECTIONAL REPEATER "Receiver" Radio RSS Configuration

```

MOTOROLA Radio Service Software                                03 Dec 90
Radius M214                                                    14:41
Version R07.10.00
-----
Model:   D04LRA7PA5AK                Coded Squelch
Serial:  778FNU1750                  UHF
Software: 009                        2 W
-----
CHANGE/VIEW: RADIO WIDE                SCREEN PRINT UTILITY
-----
                        RADIO WIDE CONFIGURATION
                        -----
MODEL INFORMATION
D04LRA7PA5AK..... 2 WATT
UHF BAND .....449.0 - 470.0 MHz
SQUELCH.....Coded
CONVENTIONAL MODES.....16
SERIAL NUMBER.....778FNU1750

OPTIONS
TIME OUT TIMER.....060
PRIORITY 2 SCAN MODE.....Off
PRIORITY SAMPLING RATE.....FAST
HANDSET.....N
SCAN TALK BACK.....Y
EMERGENCY ALARM.....NONE

ACC. INTERNAL.....NONE
ACC. EXTERNAL... GENERAL I/O
ACC. CUSTOM.....Y
  
```

```

MOTOROLA Radio Service Software                                03 Dec 90
Radius M214                                                    14:42
Version R07.10.00
-----
Model:   D04LRA7PA5AK                Coded Squelch
Serial:  778FNU1750                  UHF
Software: 009                        2 W
-----
CHANGE/VIEW: RADIO WIDE: CONN CON      SCREEN PRINT UTILITY
-----
                        ACCESSORY CONNECTOR CONFIGURATION
                        -----
INTERNAL ACCESSORY: NONE EXTERNAL ACCESSORY: GENERAL I/O CUSTOM: YES

  PIN      FUNCTION          DATA          DEBOUNCE      ACTIVE
  NUMBER   | DESCRIPTION            DIRECTION
  4         03 External Alarm      OUTPUT         NO             HIGH
  6         00 NULL                 INPUT          NO             LOW
  8         05 PL/DPL & CSQ Det    OUTPUT         NO             LOW
  9         02 Emergency Switch    INPUT         YES            HIGH
  12        00 NULL                 INPUT          NO             LOW
  14        01 NULL                 OUTPUT         NO             LOW

POWER-UP DELAY: 4.301 SEC
  
```

```

MOTOROLA Radio Service Software                                03 Dec 90
Radius M214                                                    14:40
Version R07.10.00
-----
Model:   D04LRA7PA5AK                Coded Squelch
Serial:  778FNU1750                  UHF
Software: 009                        2 W
-----
CHANGE/VIEW: MODE                      SCREEN PRINT UTILITY
-----
                        MODE CONFIGURATION
                        -----
MODE 001
NAME.....01                Busy Channel Lockout...N
TYPE.....Conventional
Rx FREQUENCY.....456.55000    PHONE Signaling System...00
Tx FREQUENCY.....456.55000    PHONE Signaling Name...NONE

Rx SQUELCH Type.....TPL        Rx Signaling System....00
Rx SQUELCH Code.....167.9 62   Rx Signaling Name.....NONE

Tx SQUELCH Type.....TPL        Tx Signaling System....00
Tx SQUELCH Code.....167.9 62   Tx Signaling Name.....NONE
  
```

# SINGLE BAND, UNIDIRECTIONAL REPEATER "Transmitter" Radio RSS Configuration

```

MOTOROLA Radio Service Software                                03 Dec 90
Radius M100                                                    13:35
Version R07.10.00
-----
Model:   D44LRA73A5AK                      Coded Squelch
Serial:  778FPC0697                        UHF
Software: 006                               35 W
-----
CHANGE/VIEW: RADIO WIDE                                SCREEN PRINT UTILITY
-----
                                RADIO WIDE CONFIGURATION
                                -----
MODEL INFORMATION                                OPTIONS
D44LRA73A5AK.....35 WATT                      TIME OUT TIMER.....060
UHF BAND .....449.0 - 470.0 MHz                HANDSET.....N
SQUELCH.....Coded
CONVENTIONAL MODES.....1
SERIAL NUMBER.....778FPC0697
    
```

```

MOTOROLA Radio Service Software                                03 Dec 90
Radius M100                                                    13:36
Version R07.10.00
-----
Model:   D44LRA73A5AK                      Coded Squelch
Serial:  778FPC0697                        UHF
Software: 006                               35 W
-----
CHANGE/VIEW: MODE                                SCREEN PRINT UTILITY
-----
                                MODE CONFIGURATION
                                -----
MODE 001
NAME.....01
TYPE.....Conventional
Rx FREQUENCY.....451.55000
Tx FREQUENCY.....451.55000

Rx SQUELCH Type.....TPL
Rx SQUELCH Code.....103.5 1A

Tx SQUELCH Type.....TPL
Tx SQUELCH Code.....103.5 1A
    
```

*Accessory connector programming for M200-series radios only:*

```

MOTOROLA Radio Service Software                                03 Dec 90
Radius M214                                                    13:42
Version R07.10.00
-----
Model:   D44LRA7PA5AK                      Coded Squelch
Serial:  778FNU1751                        UHF
Software: 009                               35 W
-----
CHANGE/VIEW: RADIO WIDE: CONN CON                SCREEN PRINT UTILITY
-----
                                ACCESSORY CONNECTOR CONFIGURATION
                                -----
INTERNAL ACCESSORY: NONE EXTERNAL ACCESSORY:          GENERAL I/O    CUSTOM: YES

  PIN      FUNCTION      DATA      DEBOUNCE      ACTIVE
  NUMBER   # DESCRIPTION   DIRECTION
  4         03 External Alarm  OUTPUT      NO             HIGH
  6         00 NULL           INPUT       NO             LOW
  8         01 NULL           OUTPUT      NO             LOW
  9         02 Emergency Switch INPUT       YES           HIGH
  12        00 NULL           INPUT       NO             LOW
  14        01 NULL           OUTPUT      NO             LOW

POWER-UP DELAY: 4.301 SEC
    
```



## R\*I\*C\*K WORKSHEET

If your application is different than those shown in the examples, this worksheet will help you to determine the proper settings for jumper JU1 and dip switch S2 in the R\*I\*C\*K. If there is any confusion with the terms then consult the "Glossary" section of this manual.

All dip switch sections should be OFF before starting the worksheet.

1. Is the repeater supposed to be in the "setup" state at power-up?

yes: place JU1 across pins 1 and 2 of J6.

no: place JU1 across pins 2 and 3 of J6.

2. Is the repeater unidirectional or bi-directional?

unidirectional: Will the "PL/DPL and CSQ" (COR) function be programmed on pin 8 or pin 14 of the accessory connector, J3, of the "receiver" radio? (Use the pin that is used by any accessory connected to "J4-ACC" or use pin 8.)

pin 8: S2-1 OFF  
S2-2 OFF  
S2-3 ON

pin 14: S2-1 OFF  
S2-2 ON  
S2-3 OFF

bi-directional: S2-1 ON  
S2-2 ON  
S2-3 OFF  
S2-10 OFF  
S2-11 ON

NOTE: J3 pin 14 of the "receiver" radio and J3 pin 8 of the "transmitter" radio must be programmed for "PL/DPL and CSQ Detect" (OUTPUT direction, active LOW).

3. Will the remote repeater setup/knockdown be used? (See the "Setup/Knockdown Operation" section of this manual.)

yes: S2-4 ON

no: S2-4 OFF

4. Is the "transmitter" radio an M100 or an M400?

yes: S2-5 OFF  
S2-6 ON  
S2-8 ON  
S2-9 OFF  
Proceed to step 7.

no: Continue on to the next question.

5. Are any of the signaling features contained in the "RapidCall" package going to be transmitted through the repeater to the field radios?

yes: S2-5 ON  
S2-6 OFF  
S2-7 OFF  
S2-8 OFF  
S2-9 ON

no: Continue on to the next question.

NOTE: All signaling (PL, DPL and RapidCall) will be generated by the field radios. The "transmitter" radio of the repeater must be programmed to transmit "CSQ".

6. Will the repeater receive and transmit the same PL tones (or DPL codes)?

\_\_\_ yes: Do you want the "transmitter" radio to generate the tone (or code)?

\_\_\_ yes: S2-5 OFF (JU551 in the M200 series  
S2-6 ON radios must be moved  
S2-8 ON to the "B" position.)  
S2-9 OFF

\_\_\_ no: S2-5 ON (JU551 in the M200 series  
S2-6 OFF radios must be moved  
S2-7 OFF to the "A" position.)  
S2-8 OFF  
S2-9 ON

\_\_\_ no: S2-5 OFF (JU551 in the M200 series  
S2-6 ON radios must be moved to  
S2-8 ON the "B" position.)  
S2-9 OFF

7. Is the "receiver" radio an M100?

\_\_\_ yes: S2-7 ON You are setting up the "VLC"  
S2-11 OFF repeater (ONLY unidirectional  
S2-12 ON configuration).

\_\_\_ no: If the "transmitter" radio is an M100 or M400 then JU551 in the M200 series radios must be moved to the "B" position.

8. What is the desired drop-out delay: 0, 1.5 or 3 seconds?

NOTE: A 0 second drop out delay is mandatory for a bi-directional repeater. A 1.5 or 3.0 second drop out delay is mandatory in the "VLC" repeater.

\_\_\_ 0 seconds: S2-10 ON  
S2-11 ON

\_\_\_ 1.5 seconds: S2-10 ON  
S2-11 OFF

\_\_\_ 3.0 seconds: S2-10 OFF  
S2-11 OFF

## M400 Interfacing With The R\*I\*C\*K

### WARNING

Before placing a Radius "2-mobile" repeater in service, Part 90 FCC Rules and Regulations must be consulted. The legal limits for frequency use, power output, coded squelch and antenna height must be determined for a given service of operation.

The Radius M400 trunk mounted radios may be used only as the "transmitter" radio and only in the unidirectional repeater configurations of the Radius "2-mobile" repeater. The interconnection to the R\*I\*C\*K is via the VIP connector on the M400 Advanced Control Head. The cable is not available from the factory; one may be assembled in the field from one of the 16-conductor cables, 3080137S01, and a VIP connector, 1580221J01.

- 1) Cut off one of the 16-pin connectors from one of the 16-conductor cables, 3080137S01, included with the R\*I\*C\*K.
- 2) Remove approximately 2" of the outer insulating jacket of the cable at the free end. Be careful not to nick the spiral wrapped shield or any of the conductors inside the cable.
- 3) Locate the RED (no striping) wire. Strip 1/8" of insulation from the end and attach a contact, 3984257L01. Place the contact into the #4 hole of the VIP connector. Push the contact through the gasket until a "click" is heard.
- 4) Locate the ORANGE (no striping) wire. Strip 1/8" of insulation from the end and attach a contact, 3984257L01. Place the contact into the #20 hole of the VIP connector. Push the contact through the gasket until a "click" is heard.
- 5) Locate the stranded, BARE "drain" wire. Twist the individual wires together to form a single lead. Slip a short length of insulated "spaghetti" tubing over the lead. Attach a contact, 3984257L01. Place the contact into the #5 hole of the VIP connector. Push the contact through the gasket until a "click" is heard.
- 6) Since the other leads of the 16-conductor cable are not used, they may be cut off near the outer insulating jacket.
- 7) Bundle the RED, ORANGE and BARE wires together and secure to the VIP connector with a tie wrap.
- 8) Plug the VIP connector into the VIP receptacle on the back of the Radius Advanced Control Head.
- 9) Plug the 16-pin connector into the "J3-TX" jack on the R\*I\*C\*K.
- 10) Continue to the sections of this manual titled "R\*I\*C\*K, Radio and Associated Hardware" and "R\*I\*C\*K Adjustments" for the completion of the setup process.

## ADJUSTMENTS AND INTERCONNECTIONS

The adjustments to the R\*I\*C\*K are the same for the "normal" and "VLC" repeater configurations. The interconnecting of the R\*I\*C\*K and the radios is different for the "VLC" and the "normal" configurations.

### R\*I\*C\*K Dip Switch S2

1. Remove the R\*I\*C\*K board from the housing if this has not been done already. Removal is accomplished by loosening the two screws at the back of the R\*I\*C\*K and pulling off the front panel. If there are any cables attached to the R\*I\*C\*K, they must be disconnected before the R\*I\*C\*K board may be removed from the rear housing.
2. Set the 12 positions of dip switch S2 according to the information from the "Repeater Examples" or the "R\*I\*C\*K Worksheet" section of this manual.

### R\*I\*C\*K and Radios Interconnection

The interconnecting of the R\*I\*C\*K and the Radius radios depends upon whether the repeater is "normal" or VLC".

#### "Normal" Repeater Interconnection

1. Remove the 16-pin connector from the accessory jack, J3, of the "receiver" radio. Place the 16-pin connector on the "J4-ACC" jack of the R\*I\*C\*K to activate the speaker of the "receiver" radio. Connect one of the 16-conductor cables, 3080137S01, between J3 of the "receiver" radio and "J5-RX" of the R\*I\*C\*K.
2. Remove the 16-pin connector from the accessory jack, J3, of the "transmitter" radio. One of the following two methods may be used to interconnect the R\*I\*C\*K and the "transmitter" radio:
  - a) Connect the other 16-conductor cable, 3080137S01, between J3 of the "transmitter" radio and "J3-TX" of the R\*I\*C\*K. (With early versions of the R\*I\*C\*K, if the speaker must be active in the "transmitter" radio, then remove the wires from pins 15 and 16 at the radio end of the 3080137S01 cable. Remove the jumper wire between pins 15 and 16 of the original 16-pin connector and place it between pins 15 and 16 of the 3080137S01 cable. Make sure the locking tabs on the terminals are facing down toward the strain relief tab and that the terminals click into place. Later versions of the

R\*I\*C\*K have pins 15 and 16 of "J3-TX" connected together.)

-or-

- b) For a unidirectional repeater that uses an M100 radio for the "transmitter" radio, connect the coiled cord, 3080043N05, between the front panel microphone jack (J11) of the radio and "J2-TX", the 6-pin modular (telco) jack of the R\*I\*C\*K.

#### "VLC" Repeater Interconnection

The "VLC" (Very Limited Capability) repeater configuration is not recommended for normal situations. The capability to use two M100 Radius radios has been included for those situations that might warrant the very short term use of a unidirectional repeater (e.g., an emergency). The VOX operation is not as positive as the COR operation that was previously described. The VOX responds to deviations of 0.8 kHz or greater from the handset audio line if the audio line-up in the M100 has a nominal output of 600 mV rms. Older radios do not have sufficient audio available to reliably activate the VOX and must be modified if a unidirectional "VLC" repeater is to be used.

1. Connect the coiled cord, 3080043N05, between the front panel microphone jack (J11) of the "receiver" radio and "J1-RX" of the R\*I\*C\*K.
2. Connect a suitable cable (such as the microphone replacement coiled cord, 3080043N05/HLN5301A) between the front panel microphone jack (J11) of the "transmitter" radio and "J2-TX" of the R\*I\*C\*K.
3. The DC power for the R\*I\*C\*K should be applied to "J5-RX" to insure that the fuse, F1, of the R\*I\*C\*K can provide protection for the associated wiring. The power may be obtained from the "receiver" radio with a suitable cable (HKN9792A, not supplied in this kit) to connect between the 5-pin accessory jack on the radio and "J5-RX" on the R\*I\*C\*K. The power may be also obtained directly from the terminals of the power supply. In either case, the cable connects the + supply terminal to pin 13 of "J5-RX" and the - supply terminal to pin 7 of "J5-RX".

### R\*I\*C\*K Adjustments

The following steps should be performed with a dummy load connected to the antenna jack of the transmitter and a Deviation Meter monitoring the output of the transmitter. An RF Signal Generator should be connected to the antenna jack of the receiver. NOTE: the definitions of transmitter and

receiver change for the reverse direction of a bi-directional repeater.

1. Connect a suitable power source to supply "12 Vdc" to the two radios.
2. Before energizing the power supply or the radios, ensure that the "REPEATER ENABLE" switch of the R\*I\*C\*K is in the released (out) position. Failure to "disable" the repeater will result in keying of the transmitter of the "transmitter" radio. Turn on the power supply and the radios.
3. Enable the repeater function by actuating the front panel "REPEATER ENABLE" switch of the R\*I\*C\*K; the green "REPEATER ENABLE" LED should light.
4. Apply an on-channel signal from the RF Signal Generator to the "receiver" radio; modulate the signal with a 1 kHz tone at 3 kHz peak deviation. Adjust R23 on the R\*I\*C\*K board for 3 kHz peak deviation of the "transmitter" radio.
5. If a bi-directional repeater is being setup, connect the RF Signal Generator to the antenna connector of the "transmitter" radio and the dummy load to the antenna connector of the "receiver" radio. Apply an on-channel signal to the receiver of the "transmitter" radio; modulate with a 1 kHz tone at 3 kHz peak deviation. Adjust R24 on the R\*I\*C\*K board for 3 kHz peak deviation of the transmitter of the "receiver" radio.
6. Check the settings of the 12 positions of dip switch S2 for correctness.
7. Unplug all cables and connectors attached to the R\*I\*C\*K board.
8. Place the R\*I\*C\*K board into the housing. Attach the front panel with the two long screws; tighten the screws snugly.

## Installation

1. Plug the microphone jack of the "receiver" radio with a shorting plug, 0180970X01, to enable the hook switch in the coded squelch mode. If it is desired to communicate on the frequency of the "receiver" radio, a mobile microphone in a hang-up clip or a desk microphone, may be substituted for the shorting plug.
2. Plug the microphone jack of the "transmitter" radio with a shorting plug, 0180970X01, to enable the hook switch in the coded squelch mode. If it is desired to communicate on the frequency of the "transmitter" radio, a mobile microphone in a hang-up clip or a desk microphone, may be substituted for the shorting plug.

NOTE: the I/O pins defined for coded squelch operation activate only with the reception of the proper tone or code regardless of the hook switch condition. The shorting plugs or the microphones allow the speakers of the two radios to remain muted to those signals without the proper tones or codes.

3. Mount the R\*I\*C\*K in a convenient location with the trunion and hardware provided in the HLN9839 Mounting Hardware Kit.
4. Reattach the cables and the 16-pin jumpered connector that were removed in step 7 of "R\*I\*C\*K Adjustments".
5. Connect the antenna RF feedlines to the two radios. The cables may come from two separate antennas or from a duplexer if a common antenna is to be used for a single band repeater.
6. Connect a suitable power source to supply "12 Vdc" to the two radios. The "12 Vdc" may come from the "12 Vdc" vehicle battery supply for a mobile repeater or an ac operated power supply for a "fixed" repeater. Two tap connectors, 0982845L01, are provided to allow paralleling two Radius mobile power cables (HKN4137A or HKN9402A) or a mobile power cable and the HKN9455A "fixed" power cable.

## DUPLEXERS, CABLES AND ANTENNA SPACING

### Duplexers

A duplexer is a device that allows two radios or a receiver and a transmitter to simultaneously operate in the same frequency band with a single antenna and transmission line. The duplexer "isolates" the "receiver" radio from the "transmitter" radio in the Radius "2-mobile" repeater. Without this isolation, the ability of the "receiver" radio to detect weak signals would be severely degraded by the output signal of the "transmitter" radio. Isolation also may be obtained by using separate antennas with proper spacing, or distance, between the antennas. It will be shown later that less vertical spacing is needed for a given isolation of land-mobile antennas than may be obtained easily with horizontal spacing.

There are two basic types of duplexers: the bandpass and the bandreject.

The bandpass duplexer has two filters connected together such that each filter will "pass", or appear transparent to, a narrow segment of frequencies; the filters are tuned to different frequencies. Any signal within the segment will be transferred from or to the antenna while frequencies outside of the segment will be "blocked".

The bandreject duplexer has two filters connected together such that each filter rejects, or "blocks", a narrow segment of frequencies. Again, the filters are tuned to different frequencies but any signal outside of the segment will be transferred from or to the antenna while frequencies within the segment will be "blocked".

The choice of which duplexer configuration to purchase may be dictated by the particular application. If several radios and a Radius "2-mobile" repeater are to operate at a given location, the bandpass duplexer might provide additional rejection to the signals from the other radios.

The basic specifications for a VHF or a UHF duplexer are:

Impedance: 50 Ohms  
Isolation: 70 dB minimum

The term "isolation" may be referred to as "Receiver (or RX) Isolation at the Transmitter Frequency" and "Transmitter (or TX) Noise Suppression at the Receiver Frequency" by the manufacturer of the duplexer.

Power handling: 50 Watts minimum  
(M100/M200)

Power Handling: 125 Watts minimum  
(M400)

Power handling may be called "Continuous Power Input" by the manufacturer. If a Lowband repeater is being assembled with the M100/M200 series Radius radios, the power handling capability would have to be increased to 100 Watts.

Insertion loss: 3 dB maximum

Less insertion loss of the duplexer means the "receiver" radio will be able to discern weaker signals and the "transmitter" radio will deliver more power output to the antenna. The 3 dB specification will result in coverage range being reduced approximately 30%. Typical insertion losses quoted in catalog sheets are 1.5 dB.

Frequency spacing: 3 MHz minimum

"Frequency spacing" is the frequency difference between the operating frequencies of the receiver and the transmitter. Frequency spacing less than 3 MHz can be achieved but the physical size of the duplexer increases dramatically. If a VHF repeater is being assembled, be aware of the minimum frequency spacing that a duplexer can provide when choosing the operating frequencies for the repeater. Also, note that the spacing in the 450 MHz to 470 MHz UHF band is 5 MHz and the spacing in the 470 MHz to 476 MHz band is 3 MHz.

If the proper equipment necessary to tune a duplexer is not available, then the duplexer must be pretuned by the manufacturer. Be ready to provide the exact receiver and transmitter frequencies at the time of purchase. Also indicate whether the duplexer will be used in a mobile or a fixed (base station) application.

Connector Type: N (female)

The type BNC connector may be used on the receiver and transmitter inputs but must be avoided for the antenna. The BNC is prone to mechanical movement which can generate noise when the transmitter is operating. Type UHF connectors will suffice for VHF but should be avoided for UHF (so why is it called a "UHF" connector?). The mini-UHF connector, if available for the duplexer, is very good. Other connectors, such as the SMA and the TNC, are very good but may be more expensive, fragile and rather difficult to assemble in the field. The best general performance comes from the type N.

### Coaxial Cabling

The coaxial cables that connect the radios to the duplexer can be fabricated from RG58A/U (the

cable that is used with most of the mobile antenna kits). Do not route the cables close to each other since RG58A/U does not have a "perfect" shield. If the routing of the cables does not allow a physical separation of approximately 1" for each foot of length, then RG400/U double shielded cable should be used. Use the minimum length of cable that is necessary to connect the duplexer to the radios.

Never use RG58A/U, RG8A/U or RG213/U as the coaxial cable that connects the duplexer to the antenna. The single layer, bare copper, loose braid of the coax shield can result in noise generation by the output signal of the transmitter. The rather small size of RG58A/U can introduce excessive losses in the system that will decrease the effective range of the repeater. Substitute RG400/U for short lengths and RG214/U or 1/2-inch "hardline" for the longer lengths. If the "hardline" is used, then connect the duplexer to the end of the "hardline" with a flexible jumper cable to avoid undue stress on the connectors of the cables and the duplexer.

In planning a system, make sure that the various connectors found on the radios, duplexer, feedlines, feedline jumpers and antenna are the correct "mating pairs".

The chart shown in Table 1 on the following page can be used to determine which feedline to choose for a given frequency band and line length.

To further assist you, Table 2 provides a list of Motorola part numbers for the various connectors and cables which may be used.

### Antenna Spacing

Isolation between the the output from the transmitter and the input to the receiver may be obtained with physical distance. Instead of using a duplexer, two antennas may be spaced apart and connected to the "receiver" radio and the "transmitter" radio with separate transmission lines. The separation necessary to yield the desired 70 dB of isolation is dependent upon the frequency band of operation. It is obvious from the following charts that vertical spacing will get the 70 dB more easily than horizontal spacing. The horizontal spacing may be reduced

if buildings or hills or mountains are present between the antennas; the amount of reduction will have to be determined by experiment ("trial and error").

#### VERTICAL SPACING

FREQ (MHz)	SPACING	
	(ft)	(m)
30	295	90
40	220	68
50	177	54
150	59	18
170	52	16
400	22	7
470	20	6

NOTE: The two antennas will couple to a metallic support; the position of one of the antennas may have to be varied to obtain the desired isolation. Generally, the receive antenna is placed above the transmit antenna, for enhanced receive coverage from portable units.

#### HORIZONTAL SPACING

FREQ (MHz)	SPACING	
	(ft)	(m)
30	12,800	3,900
150	2,600	780
400	960	293

NOTE: The losses associated with long transmission lines have not been included in the calculations of the spacings. It is readily seen that horizontal spacing of antennas is somewhat useless; the cost of the transmission lines to the two antennas would be greater than the cost of a duplexer.

*Table 1. Maximum Length of Feedline in Feet (Meters)*

<b>BAND</b>	<b>RG400/U</b>	<b>RG214/U</b>	<b>1/2" Hardline</b>
Low (50 MHz)	55 (17)	100 (30)	300 (90)
VHF (150 MHz)	25 (7.5)	50 (15)	150 (45)
UHF (450 MHz)	15 (4.5)	25 (7.5)	90 (27)
800 MHz	10 (3)	20 (6)	70 (21)

*Table 2. Motorola Part Numbers for Connector and Coaxial Cable*

<b>PART</b>	<b>MOTOROLA P/N</b>
mini-UHF male connector	28-84606M01
UHF male connector	28-84579F04
type-N male connector	28-84476G01
type-N hardline male	RRX-4007A
type-N hardline female	RRX-4008A
RG58A/U coaxial cable	30-00475378
RG400/U coaxial cable	30-84173E01
RG214/U coaxial cable	30-15068A17
1/2" hardline cable	30-80329A22
8 ft jumper cable	01-84605A02



## Accessory Compatibility with the R\*I\*C\*K

**NOTE:** The accessories may be used ONLY with the unidirectional configurations.

The "ACCESSORY CONNECTOR CONFIGURATION" screens of the RSS show the required J3 pin connections for the Radius accessories. The signals that the accessories require are available at "J4-ACC" on the R\*I\*C\*K. The following table lists:

- 1) the pin on J3 of the "receiver" radio (COR signal),
- 2) the position for jumper JU551 in the "receiver" radio,
- 3) the settings of dip switch S2 sections -2, -3, -5, -6 and -7 in the R\*I\*C\*K, and
- 4) if an M100 or an M400 radio can be the "trans-

mitter" radio in the repeater and use a particular accessory.

If the accessory has not defined a "PL/DPL & CSQ Det" COR signal on either pin 8 or pin 14 of J3 of the "receiver" radio, then use the pin listed in the chart below. Program Function #05 "PL/DPL & CSQ Det" with NO debounce and LOW active level.

## Radio Programming Screens

In this section, the screens from the RSS with suggested programming for the "receiver" radio and the "transmitter" radio will be presented. As is true with the default settings for any given accessory, it is believed that these should suffice for the majority of applications.

**NOTE:** The GENERAL I/O screen is used for programming the "receiver" radio for a Radius "2-mobile" repeater when Modem paging is the desired accessory.

*Table 3. Accessory Compatibility Chart for the R\*I\*C\*K*

Accessory	COR PIN	JU-551	S2-2	S2-3	S2-5	S2-6	S2-7	M100/M400
DTMF Decoder (1)	14	B	ON	OFF	OFF	ON	ON	YES
MDC-1200 Console	8	A	OFF	ON	ON	OFF	OFF	NO
Modem Paging	14	A	ON	OFF	ON	OFF	OFF	NO
Phone Patch	8	B	OFF	ON	OFF	ON	ON	NO
Public Address	8	A	OFF	ON	ON	OFF	OFF	NO
Remote	8	B	OFF	ON	OFF	ON	OFF	YES
RPB50 Interface (2)	8	A	OFF	ON	ON	OFF	OFF	NO

(1) If the DTMF Decoder is present, only two of the three external accessories are compatible with the R\*I\*C\*K:

- (a) the Public Address accessory may not be used
- (b) the Remote will lose the "I/O Mic Off Hook"
- (c) the "General I/O" operates normally.

(2) The Encoder model, E08ZPE0001, with either the HKN9547 (6 ft cable) or the HKN9555 (100 ft cable) should be used in this R\*I\*C\*K application. Note that the "I/O Mic Off Hook" function will not operate.

# MODEN PAGING

```

MOTOROLA Radio Service Software                               12 Dec 90
Radius M214                                                  12:21
Version R07.00.00
-----
Model:   D04LRA7PA5AK           Coded Squelch
Serial:  778RPTRX02            UHF
Software: 009                   2 W
-----
CHANGE/VIEW:RADIO WIDE:CONN CON                SCREEN PRINT UTILITY
-----
                        ACCESSORY CONNECTOR CONFIGURATION
                        -----
INTERNAL ACCESSORY: NONE EXTERNAL ACCESSORY:      GENERAL I/O    CUSTOM: YES

  PIN      FUNCTION          DATA          DEBOUNCE    ACTIVE
  NUMBER   # DESCRIPTION        DIRECTION      NO          LEVEL
  4         03 External Alarm      OUTPUT         NO          HIGH
  6         00 NULL                INPUT          NO          LOW
  8         00 NULL                INPUT          NO          LOW
  9         02 Emergency Switch  INPUT         YES         HIGH
  12        00 NULL                INPUT          NO          LOW
  14        05 PL/DPL & CSQ Det  OUTPUT         NO          LOW

POWER-UP DELAY:  4.301 SEC
  
```

# "RECEIVER" RADIO

```

MOTOROLA Radio Service Software                               12 Dec 90
Radius M214                                                  12:19
Version R07.00.00
-----
Model:   D44LRA7PA5AK           Coded Squelch
Serial:  778FNU1750            UHF
Software: 009                   35 W
-----
CHANGE/VIEW:RADIO WIDE:CONN CON                SCREEN PRINT UTILITY
-----
                        ACCESSORY CONNECTOR CONFIGURATION
                        -----
INTERNAL ACCESSORY: NONE EXTERNAL ACCESSORY:      MODEN PAGING    CUSTOM: YES

  PIN      FUNCTION          DATA          DEBOUNCE    ACTIVE
  NUMBER   # DESCRIPTION        DIRECTION      NO          LEVEL
  4         03 External Alarm      OUTPUT         NO          HIGH
  6         12 Page PTT          INPUT          NO          LOW
  8         14 Tx Audio Mute     INPUT          NO          LOW
  9         02 Emergency Switch  INPUT         YES         HIGH
  12        06 Tx PL Inhibit   INPUT          NO          LOW
  14        01 NULL                OUTPUT         NO          LOW

POWER-UP DELAY:  4.301 SEC
  
```

# "TRANSMITTER" RADIO

# PHONE PATCH

```

MOTOROLA Radio Service Software                               12 Dec 90
Radius M214                                                  12:28
Version R07.00.00
-----
Model:   D04LRA7PA5AK           Coded Squelch
Serial:  778RPTRX02            UHF
Software: 009                  2 W
-----
CHANGE/VIEW:RADIO WIDE:CONN CON          SCREEN PRINT UTILITY
-----

                ACCESSORY CONNECTOR CONFIGURATION
                -----
INTERNAL ACCESSORY: NONE EXTERNAL ACCESSORY:          PHONE PATCH    CUSTOM: NO

  PIN      FUNCTION      DATA      DEBOUNCE      ACTIVE
  NUMBER   # DESCRIPTION  DIRECTION  DEBOUNCE      LEVEL
  4         03 External Alarm  OUTPUT     NO            HIGH
  6         06 Tx PL Inhibit  INPUT      NO            LOW
  8         05 PL/DPL & CSQ Det  OUTPUT     NO            LOW
  9         02 Emergency Switch  INPUT      YES           HIGH
  12        11 Phone Patch Inh.  OUTPUT     NO            HIGH
  14        07 CSQ Detect        OUTPUT     NO            LOW

POWER-UP DELAY:  4.301 SEC
    
```

# "RECEIVER" RADIO

```

MOTOROLA Radio Service Software                               12 Dec 90
Radius M214                                                  12:27
Version R07.00.00
-----
Model:   D44LRA7PA5AK           Coded Squelch
Serial:  778FNUL1750          UHF
Software: 009                  35 W
-----
CHANGE/VIEW:RADIO WIDE:CONN CON          SCREEN PRINT UTILITY
-----

                ACCESSORY CONNECTOR CONFIGURATION
                -----
INTERNAL ACCESSORY: NONE EXTERNAL ACCESSORY:          PHONE PATCH    CUSTOM: YES

  PIN      FUNCTION      DATA      DEBOUNCE      ACTIVE
  NUMBER   # DESCRIPTION  DIRECTION  DEBOUNCE      LEVEL
  4         03 External Alarm  OUTPUT     NO            HIGH
  6         06 Tx PL Inhibit  INPUT      NO            LOW
  8         01 NULL              OUTPUT     NO            LOW
  9         02 Emergency Switch  INPUT      YES           HIGH
  12        11 Phone Patch Inh.  OUTPUT     NO            HIGH
  14        01 NULL              OUTPUT     NO            LOW

POWER-UP DELAY:  4.301 SEC
    
```

# "TRANSMITTER" RADIO

# PUBLIC ADDRESS

```

MOTOROLA Radio Service Software                               12 Dec 90
Radius M214                                                  12:27
Version R07.00.00
-----
Model:   D04LRA7PA5AK                                     Coded Squelch
Serial:  778RPTRX02                                       UHF
Software: 009                                             2 W
-----
CHANGE/VIEW:RADIO WIDE:CONN CON                            SCREEN PRINT UTILITY
-----
                                ACCESSORY CONNECTOR CONFIGURATION
                                -----
INTERNAL ACCESSORY: NONE EXTERNAL ACCESSORY: PUBLIC ADDRESS CUSTOM: YES

  PIN      FUNCTION      DATA      DEBOUNCE      ACTIVE
  NUMBER   # DESCRIPTION   DIRECTION
  4         03 External Alarm  OUTPUT      NO             HIGH
  6         00 NULL          INPUT       NO             LOW
  8         05 PL/DPL & CSQ Det  OUTPUT      NO             LOW
  9         02 Emergency Switch  INPUT       YES            HIGH
  12        00 NULL          INPUT       NO             LOW
  14        04 PA Switch    INPUT       YES            LOW

POWER-UP DELAY: 4.301 SEC
  
```

# "RECEIVER" RADIO

```

MOTOROLA Radio Service Software                               12 Dec 90
Radius M214                                                  12:22
Version R07.00.00
-----
Model:   D44LRA7PA5AK                                     Coded Squelch
Serial:  778FNU1750                                       UHF
Software: 009                                             35 W
-----
CHANGE/VIEW:RADIO WIDE:CONN CON                            SCREEN PRINT UTILITY
-----
                                ACCESSORY CONNECTOR CONFIGURATION
                                -----
INTERNAL ACCESSORY: NONE EXTERNAL ACCESSORY: PUBLIC ADDRESS CUSTOM: YES

  PIN      FUNCTION      DATA      DEBOUNCE      ACTIVE
  NUMBER   # DESCRIPTION   DIRECTION
  4         03 External Alarm  OUTPUT      NO             HIGH
  6         00 NULL          INPUT       NO             LOW
  8         01 NULL          OUTPUT      NO             LOW
  9         02 Emergency Switch  INPUT       YES            HIGH
  12        00 NULL          INPUT       NO             LOW
  14        04 PA Switch    INPUT       YES            LOW

POWER-UP DELAY: 4.301 SEC
  
```

# "TRANSMITTER" RADIO

# REMOTE

```
MOTOROLA Radio Service Software                      12 Dec 90
Radius M214                                           12:28
Version R07.00.00
-----
Model:   D04LRA7PA5AK                               Coded Squelch
Serial:  778RPTRX02                                UHF
Software: 009                                       2 W
-----
CHANGE/VIEW:RADIO WIDE:CONN CON                    SCREEN PRINT UTILITY
-----

                        ACCESSORY CONNECTOR CONFIGURATION
-----
INTERNAL ACCESSORY: NONE EXTERNAL ACCESSORY:          REMOTE    CUSTOM: YES

  PIN      FUNCTION      DATA      ACTIVE
  NUMBER   # DESCRIPTION   DIRECTION  DEBOUNCE  LEVEL
  4         03 External Alarm  OUTPUT     NO         HIGH
  6         00 NULL          INPUT      NO         LOW
  8         05 PL/DPL & CSQ Det  OUTPUT     NO         LOW
  9         02 Emergency Switch  INPUT      YES        HIGH
  12        00 NULL          INPUT      NO         LOW
  14        10 I/O Mic Off Hook  INPUT      YES        LOW

POWER-UP DELAY: 4.301 SEC
```

# "RECEIVER" RADIO

```
MOTOROLA Radio Service Software                      12 Dec 90
Radius M214                                           12:28
Version R07.00.00
-----
Model:   D44LRA7PA5AK                               Coded Squelch
Serial:  778FNU1750                                UHF
Software: 009                                       35 W
-----
CHANGE/VIEW:RADIO WIDE:CONN CON                    SCREEN PRINT UTILITY
-----

                        ACCESSORY CONNECTOR CONFIGURATION
-----
INTERNAL ACCESSORY: NONE EXTERNAL ACCESSORY:          REMOTE    CUSTOM: YES

  PIN      FUNCTION      DATA      ACTIVE
  NUMBER   # DESCRIPTION   DIRECTION  DEBOUNCE  LEVEL
  4         03 External Alarm  OUTPUT     NO         HIGH
  6         00 NULL          INPUT      NO         LOW
  8         01 NULL          OUTPUT     NO         LOW
  9         02 Emergency Switch  INPUT      YES        HIGH
  12        00 NULL          INPUT      NO         LOW
  14        10 I/O Mic Off Hook  INPUT      YES        LOW

POWER-UP DELAY: 4.301 SEC
```

# "TRANSMITTER" RADIO

# RPB50\_INTERFACE

```

MOTOROLA Radio Service Software                               12 Dec 90
Radius M214                                                  12:29
Version R07.00.00
-----
Model:   D04LRA7PA5AK                                       Coded Squelch
Serial:  778RPTRX02                                         UHF
Software: 009                                               2 W
-----
CHANGE/VIEW:RADIO WIDE:CONN CON                             SCREEN PRINT UTILITY
-----
                        ACCESSORY CONNECTOR CONFIGURATION
-----
INTERNAL ACCESSORY: NONE EXTERNAL ACCESSORY:                REMOTE    CUSTOM: YES

  PIN      FUNCTION      DATA      ACTIVE
  NUMBER   # DESCRIPTION  DIRECTION  DEBOUNCE  LEVEL
  4        01 NULL          OUTPUT     NO         LOW
  6        00 NULL          INPUT      NO         LOW
  8        05 PL/DPL & CSQ Det  OUTPUT     NO         LOW
  9        00 NULL          INPUT      NO         LOW
  12       07 CSQ Detect      OUTPUT     NO         LOW
  14       10 I/O Mic Off Hook  INPUT      YES        HIGH

POWER-UP DELAY:  4.301 SEC
  
```

## "RECEIVER" RADIO

```

MOTOROLA Radio Service Software                               12 Dec 90
Radius M214                                                  12:29
Version R07.00.00
-----
Model:   D44LRA7PA5AK                                       Coded Squelch
Serial:  778FNU1750                                         UHF
Software: 009                                               35 W
-----
CHANGE/VIEW:RADIO WIDE:CONN CON                             SCREEN PRINT UTILITY
-----
                        ACCESSORY CONNECTOR CONFIGURATION
-----
INTERNAL ACCESSORY: NONE EXTERNAL ACCESSORY:                REMOTE    CUSTOM: YES

  PIN      FUNCTION      DATA      ACTIVE
  NUMBER   # DESCRIPTION  DIRECTION  DEBOUNCE  LEVEL
  4        01 NULL          OUTPUT     NO         LOW
  6        06 Tx PL Inhibit    INPUT      NO         LOW
  8        00 NULL          INPUT      NO         LOW
  9        00 NULL          INPUT      NO         LOW
  12       01 NULL          OUTPUT     NO         LOW
  14       10 I/O Mic Off Hook  INPUT      YES        HIGH

POWER-UP DELAY:  4.301 SEC
  
```

## "TRANSMITTER" RADIO

## Setup/Knockdown Operation

The ignition control of the "transmitter" radio of a repeater may be turned on and off either locally or remotely to provide a "setup/knockdown" action for the repeater. The supply voltage for the ignition control input is switched electronically by the R\*I\*C\*K.

1. Fuse F801 (or jumper JU801 in earlier models) on the logic board of the "transmitter" radio must be removed in order to enable the setup/knockdown feature.
  2. The "power-up" state of the repeater upon the initial application of supply voltage is determined by jumper JU1 on J6 of the R\*I\*C\*K.
    - a) Place the 2-pin push-on jumper, JU1, on pins 1 and 2 of J6 if the repeater is to be initialized in the "setup" (ON) state. The local and remote control will then toggle the repeater between the "setup" and "knockdown" (OFF) states.
    - b) Place the 2-pin push-on jumper, JU1, on pins 2 and 3 of J6 if the repeater is to initialize in the "knockdown" (OFF) state. The local and remote control will then toggle the repeater between the "knockdown" and "setup" (ON) states.
  3. The remote setup/knockdown control is enabled in the R\*I\*C\*K by placing switch S2-4 in the ON position.
  4. The "receiver" radio, at the least, must be an M200 series radio.
    - a) The "Call List" of the "receiver" radio must include the identification of a controlling field radio (defined as a "console" with the Radio Service Software).
    - b) The "receiver" radio must be programmed to receive and transmit on the receive frequency of the repeater.
    - c) The Call List of the console must also contain the identification of the "receiver" radio.
    - d) The console radio must have a mode (or channel) allocated to receive and transmit on the frequency of the "receiver" radio of the repeater.
    - e) If an Emergency Alert by the "receiver" radio is desired as a verification when the repeater has knocked down (OFF), then program the "receiver" radio to transmit an Emergency Alert.
    - f) Program the console (radio) and the "receiver" radio of the repeater for the MDC-1200 signaling format. Refer to the Rapid-Call Planning Guide and RapidCall Instruction Manual.
  5. To knockdown a repeater that is setup:
    - a) Initiate a Call Alert from the console to the "receiver" radio; use the ID number that was assigned to the "receiver" radio.
    - b) If the "receiver" radio has been programmed to transmit an Emergency Alert, the Alert will be transmitted by the "receiver" radio when the repeater assumes the knockdown state.
    - c) Clear the Emergency Alert at the console (refer to the Radius RapidCall Planning Guide).
- NOTE: An Emergency Alert will be transmitted by the "receiver" radio upon application of supply voltage if the repeater initializes in the knockdown condition (J6-2 jumpered to J6-3 in the R\*I\*C\*K).
6. To setup a repeater that is in the knockdown condition:
    - a) Initiate a Call Alert to the "receiver" radio from the console; use the ID number that was assigned to the "receiver" radio.
    - b) The transmitter of the "receiver" radio will transmit a Call Alert to the console to verify that the repeater is setup.

## Dip Switch (S2) Functions

R\*I\*C\*K DIP switch S2 positions ( \* = typical setup):

**S2-1:** S2-1 routes the PL/DPL & CSQ I/O signal (active low) from J3 pin 8 of the "transmitter" radio to J3 pin 3, the PTT, of the "receiver" radio in the bi-directional repeater configurations. For unidirectional repeaters, S2-1 should be OFF.

S2-1: OFF for uni-directional repeaters \*  
ON for bi-directional repeaters

**S2-2 and S2-3:** S2-2 selects pin 14 of "J5-RX" as the COR input from the "receiver" radio; S2-3 selects pin 8 of "J5-RX" for the same function. Either S2-2 or S2-3 should be ON with the other switch in the OFF position. No harm to the R\*I\*C\*K or the "receiver" radio will occur if both of the switches are accidentally ON. In the bi-directional repeater configuration continuous keying of the transmitter of the "receiver" radio will occur if S2-3 is ON; therefore, S2-2 (pin 14 I/O) must be used.

S2-2: OFF for PIN 8 I/O (CSQ or PL/DPL) \*  
ON for PIN 14 I/O (CSQ or PL/DPL)

S2-3: OFF for PIN 14 I/O (CSQ or PL/DPL) \*  
ON for PIN 8 I/O (CSQ or PL/DPL) \*

**S2-4:** S2-4 enables the remote Setup/Knockdown feature which requires the MDC-1200 RapidCall signaling format with an M200 series radio for the "receiver" radio. The R\*I\*C\*K supplies operating voltage to J3 pin 10, the ignition control input, of the "transmitter" radio. See the section of these instructions for "Setup/Knockdown Operation."

S2-4: OFF for local only repeater Setup/Knockdown \*  
ON to enable remote Setup/Knockdown (MDC-1200)

**S2-5 and S2-6:** S2-5 and S2-6 are used to select the routing of the audio from the receiver of the "receiver" radio to the proper audio input of the "transmitter" radio. If a normal EIA de-emphasized audio response is selected from the "receiver" radio, then an EIA pre-emphasized response is required in the "transmitter" radio and S2-6 should be ON (S2-5 should be OFF). If a flat audio response is selected from the "receiver" radio, then a flat audio response is required in the "transmitter" radio and S2-5 should be ON (S2-6 should be OFF).

S2-5: OFF for EIA de-emphasized/pre-emphasized audio \*  
ON for flat audio

S2-6: OFF for flat audio

ON for EIA de-emphasized/pre-emphasized audio \*

**S2-7:** S2-7 enables the audio path through the audio gate (Q8). S2-7 is ON when VOX is used. EIA de-emphasized/muted audio must be provided by the "receiver" radio.

S2-7: OFF for COR applications \*  
ON for VOX operation

**S2-8 and S2-9:** S2-8 and S2-9 duplicate the functions of S2-6 and S2-5 for the audio input to the transmitter of the "receiver" radio in a bi-directional repeater (note the reverse order for the corresponding functions). The typical bi-directional repeater will use de-emphasized receiver audio from the "transmitter" radio and S2-8 should be ON (S2-9 should be OFF).

S2-8: OFF for flat audio  
ON for EIA de-emphasized/pre-emphasized audio \*

S2-9: OFF for EIA de-emphasized/pre-emphasized audio \*  
ON for flat audio

**S2-10 and S2-11:** S2-10 and S2-11 select the desired drop-out delay (hang time). With both switches OFF, the "transmitter" radio will unkey approximately 3 seconds after loss of the COR indication by the "receiver" radio (J3 pin 8 or pin 14 goes high). The dropout delay is decreased to approximately 1.5 seconds if S2-10 is ON. The shortest dropout delay, essentially "zero" seconds, is enabled by placing S2-11 in the ON position. For a bi-directional repeater, the "0" seconds dropout delay (S2-11 ON and S2-10 OFF or ON) should be used.

S2-10: OFF for 3 second drop-out delay \*  
ON for 1.5 second drop-out delay

S2-11: OFF for 1.5/3 second drop-out delay \*  
ON for 0 second drop-out delay

**S2-12:** S2-12 allows the output of the VOX circuit to key the "transmitter" radio in the "VLC" repeater configuration. Note that the "zero" dropout delay should NOT be used with the VOX keying; a delay of 1.5 or 3 seconds should be used to "smooth" the output of the VOX. The audio gate must be enabled by placing S2-7 in the ON position. The VOX circuit operates only in a unidirectional mode (i.e., from the handset audio of the "receiver" radio). The VOX will also respond to the noise burst, or "squelch tail", at the end of a transmission and the dropout delay will increase by that amount; use of coded squelch (PL or DPL) is recommended.

S2-12: OFF for VOX disable \*  
ON for VOX enable



## Theory Of Operation

### 1) SETUP/KNOCKDOWN (U1A, Q1, Q2, Q3, Q4, Q11 and Q12):

U1A is one half of an IC dual type-D flip flop, an MC14013B. U1A is configured as a data latch. The CLEAR input, pin 4, is wired low. At power-up, the PRESET input of U1A, pin 6, is momentarily taken high via C2 and R9 and causes the "Q" output, pin 1, to go high and the "not-Q" output, pin 2, to go low. The "Q" output is connected to pin 1 of J6 and the "not-Q" output is connected to pin 3 of J6. If JU1 is across pins 1 and 2 of J6, then the repeater will be in the "Set-up" condition at power-up. If JU1 is across pins 2 and 3 of J6, then the repeater will be in the "Knockdown" condition at power-up.

The electronic switch, Q2/Q3, causes the Set-up/Knockdown action by applying or removing voltage at the ignition control, pin 10, of "J3-TX". After power-up, the Setup or Knockdown state may be changed remotely with a signal from pin 4 of "J5-RX" or locally with front panel switch S3. S3 is a momentary contact switch that is debounced by the Q11/ Q12 latch circuit. The yellow "SET-UP" LED, CR3, illuminates to indicate the Set-up state.

As the Setup/Knockdown circuit goes from the Knockdown to the Set-up state, Q1 is momentarily turned on by Q3 via the C1/R2 timing circuit. The push to talk (PTT) input of the "receiver" radio, pin 3 of "J5-RX" is pulled low by Q1 and keys the transmitter. The "COR" LED, CR2, will briefly flash during the moment that Q1 is conducting.

The external alarm input of the "receiver" radio, pin 4 of "J5- RX", is held low by Q4 during the Set-up state. As the Setup/Knockdown circuit changes from Set-up to Knockdown, Q4 turns off. The transmitter of the "receiver" radio will key and send an Emergency Alarm if that feature has been enabled.

### 2) VOX (Q9):

Any audio signal present at pin 1 of "J1-RX" or pin 11 of "J5-RX" causes Q9 to conduct. This in turn will activate the drop-out delay and push to talk circuitry.

### 3) COR BUFFER (Q15):

Q15 is a dc amplifier (buffer) for the COR signal from pin 8, through S2-3, or from pin 14, through S2-2, of "J5-RX". The output of Q15 is switched from a low state during inactivity of the repeater to a high state with an active low state for the COR signal.

### 4) AUDIO GATE (Q6 and Q8):

The audio gate, Q8, enables and disables the audio from the "receiver" radio. The audio input to Q8 is from pin 1 of "J1-RX" or pin 11 of "J5-RX". The output of Q8 is applied to pin 11 of "J4-ACC" and potentiometer, R23. The output of R23 is applied to S2-5 and S2-6. S2-5 will route the audio to the "flat transmitter audio", pin 5 of "J3-TX" and "J4-ACC". S2-6 will route the audio to the "microphone transmitter audio", pin 3 of "J2-TX" and pins 2 of "J3-TX" and "J4-ACC". R23 is used to adjust the "receiver" radio audio output to the proper level for the "transmitter" radio audio input. The audio gate is enabled with an active dc level low at either pin 8 or pin 14 of "J5-RX". The gate can also be hard enabled if S2-7 is closed.

### 5) DROPOUT DELAY AND PTT (Q5, Q10, U1B and Q7):

The dropout delay circuit uses the second half of U1, the MC14013B dual D flip flop to generate a PTT signal for the "transmitter" radio. The Q output, pin 13, of U1B is low if the repeater is inactive. When an input signal is present at the "receiver" radio, either pin 8 or pin 14 of "J5-RX" will be pulled low and turn off Q15. Q5 will turn on and discharge C3. Q10 will turn on when the voltage across C3 is less than 4.5 Vdc. The output from Q10 pulls the PRESET input of U1B high. The Q output of U1B switches to a high state and turns on Q7. Pin 4 of "J2-TX" and pin 3 of "J3-TX" are pulled low and key the "transmitter" radio PTT. The red "COR" LED, CR2, illuminates.

The dropout delay is generated when Q5 ceases to conduct. Q10 will remain on until the voltage across C3 reaches 4.5 Vdc or greater. S2-10 and S2-11 are used to switch in the appropriate resistance to generate the desired time constant.

S1 on the front panel is used to enable the repeater function and will not allow Q7 to conduct unless it is in the enable (in) position. S1 also interrupts the COR signal from pin 8 or pin 14 of "J5-RX" and the output of the VOX circuit to disable the repeater.

### 6) REVERSE KEY-UP:

Whenever pin 8 of "J3-TX" goes low, it will pull pin 3 of "J5-RX" low. When the reverse key-up function is being used, as in the bi-directional repeater configuration, S2-3 must be open and no functions can be programmed which will use pin 8 of "J5-RX". A NULL with active LOW STATE on pin 8 will prevent any unwanted reverse key-up.

**7) REVERSE AUDIO PATH:**

Audio present on pin 11 of "J3-TX" is routed to either pin 2 or pin 5 of "J5-RX". S2-8 and S2-9 determine to which pin the audio is routed. As with the forward direction, a potentiometer, R24, is used to adjust the audio level.

**8) ACCESSORY JACK ("J4-ACC"):**

The accessory jack, "J4-ACC", is connected to "J3-TX" and "J5-RX" such that all of the Radius standard accessories will still be compatible. Furthermore, the standard connections are retained (no new cables need to be made). The only input which causes the R\*I\*C\*K to respond is pin 3 of "J4-ACC" (PTT). A low on the pin will cause a low on pin 3 of "J3-TX" and keying of the "transmitter" radio and illuminating of the red "COR" LED, CR2.

## Troubleshooting Procedures

Table 4. R\*I\*C\*K General Problems

Problem	Possible Cause
R*I*C*K dead, green LED does not light when enable switch is depressed.	<ol style="list-style-type: none"> <li>1. "Receiver" radio not turned ON.</li> <li>2. Loose or bad cable from "receiver" radio to R*I*C*K.</li> <li>3. Open fuse, F1, in R*I*C*K.</li> <li>4. External supply not turned ON (if applicable).</li> </ol>
First part of message not repeated.	<ol style="list-style-type: none"> <li>1. The user must delay conversation to allow for delays in repeater and field radios from:               <ol style="list-style-type: none"> <li>a. PL/DPL decoding.</li> <li>b. Requirements of signalling systems.</li> </ol> </li> <li>2. If using VOX:               <ol style="list-style-type: none"> <li>a. User speaking too softly.</li> <li>b. Inadequate handset audio level from "receiver" radio.</li> </ol> </li> </ol>
In bi-directional repeater configuration, part or all of the reverse conversation not repeated.	<ol style="list-style-type: none"> <li>1. 0-second drop-out delay not selected (S2-11 not ON).</li> <li>2. The user must delay conversation to allow for delays in repeater and field radios from:               <ol style="list-style-type: none"> <li>a. PL/DPL decoding.</li> <li>b. Requirements of signalling systems.</li> </ol> </li> <li>3. "Receiver" radio is operating in another repeater system and is keeping "transmitter" radio keyed during drop-out delay. Consult Radius Product Services for possible remedy.</li> </ol>
"Tinny" repeated audio (lacks low frequencies).	<ol style="list-style-type: none"> <li>1. Flat receive audio selected with microphone transmit audio. Check:               <ol style="list-style-type: none"> <li>a. Position of JU551 in "receiver" radio.</li> <li>b. S2-5 and S2-6 in R*I*C*K.</li> <li>c. If bi-directional, position of JU551 in "transmitter" radio.</li> <li>d. If bi-directional, S2-8 and S2-9 in R*I*C*K.</li> </ol> </li> </ol>
"Bassy" repeated audio (lacks high frequencies).	<ol style="list-style-type: none"> <li>1. EIA de-emphasized receive audio selected with flat transmit audio. Check:               <ol style="list-style-type: none"> <li>a. Position of JU551 in "receiver" radio.</li> <li>b. S2-5 and S2-6 in R*I*C*K.</li> <li>c. If bi-directional, position of JU551 in "transmitter" radio.</li> <li>d. If bi-directional, S2-8 and S2-9 in R*I*C*K.</li> </ol> </li> </ol>
PL/DPL signalling "passing through" R*I*C*K.	<ol style="list-style-type: none"> <li>1. Flat receive audio selected. See "Tinny" repeated audio" above.</li> </ol>
PL/DPL signalling not "passing through" R*I*C*K.	<ol style="list-style-type: none"> <li>1. EIA de-emphasized receive audio selected. See "Bassy" repeated audio" above.</li> </ol>
Undesirable squelch tails and noise transmitted during drop-out delay.	<ol style="list-style-type: none"> <li>1. Audio gate enabled with flat receive audio selected (S2-7 ON, should be OFF).</li> </ol>
Audio OK in repeater operation (between field radios) but noisy when using local microphone on a repeater radio.	<ol style="list-style-type: none"> <li>1. Flat audio has been selected. Select EIA de-emphasized/muted audio on repeater radios (JU551 on logic board of each radio must be in "B" position).</li> <li>2. If flat audio is selected, S2-7 in R*I*C*K should be OFF.</li> </ol>

Table 5. R\*I\*C\*K "Receiver" Radio Problems

Problem	Possible Cause
"Receiver" radio constantly keyed.	<ol style="list-style-type: none"> <li>1. Accessory connector of "receiver" and/or "transmitter" radio not programmed correctly or not operating correctly.</li> <li>2. S2 of R*I*C*K not configured correctly.</li> <li>3. J4-8 of R*I*C*K pulled LOW by an accessory.</li> </ol>
Transmitter of "receiver" radio not keying in bi-directional mode.	<ol style="list-style-type: none"> <li>1. Loose or bad cable(s).</li> <li>2. S2-1 of R*I*C*K not ON.</li> <li>3. Accessory connector of "transmitter" radio not programmed correctly or not operating correctly.</li> <li>4. No transmit frequency programmed into "receiver" radio.</li> </ol>
No or low transmitter audio from "receiver" radio in bi-directional mode.	<ol style="list-style-type: none"> <li>1. Loose or bad cable(s).</li> <li>2. S2 of R*I*C*K not configured correctly.</li> <li>3. JU551 missing on logic board of "transmitter" radio.</li> <li>4. R24 of R*I*C*K not adjusted correctly.</li> <li>5. Audio loaded by an accessory connected to "J4-ACC" of R*I*C*K.</li> </ol>
Loss of receiver sensitivity when "transmitter" radio is keyed. (Repeater toggles from transmit to receive repeatedly when attempting to communicate through it.)	<ol style="list-style-type: none"> <li>1. Leaky coaxial cable(s).</li> <li>2. Loose antenna connector(s).</li> <li>3. Faulty antenna connector(s).</li> <li>4. Duplexer not tuned correctly (if applicable).</li> <li>5. Inadequate separation between receiver and transmitter antennas (if applicable).</li> <li>6. Improper or faulty coaxial cable(s) to antenna(s).</li> </ol>
No speaker audio heard from "receiver" radio.	<ol style="list-style-type: none"> <li>1. J4-15 and J4-16 of R*I*C*K not jumpered together.</li> <li>2. Loose or bad cable from "receiver" radio to R*I*C*K.</li> <li>3. Volume control of "receiver" radio turned down.</li> <li>4. Speaker wires not connected between speaker and J10 on logic board of "receiver" radio.</li> <li>5. External speaker (if applicable) not connected between J4-1 and J4-16 of R*I*C*K.</li> <li>6. Defective speaker (internal or external, if applicable).</li> </ol>

Table 6. R\*I\*C\*K "Transmitter" Radio Problems

Problem	Possible Cause
"Transmitter" radio not keying when a "properly" identified signal is presented to "receiver" radio.	<ol style="list-style-type: none"> <li>1. R*I*C*K not in Setup state.</li> <li>2. R*I*C*K not enabled.</li> <li>3. Loose or bad cable(s).</li> <li>4. "Receiver" radio on wrong channel (mode).</li> <li>5. No transmit frequency programmed into "transmitter" radio.</li> <li>6. S2 of R*I*C*K not configured correctly.</li> <li>7. Incorrect frequency and/or PL/DPL programmed into "receiver" radio.</li> <li>8. Accessory connector of "receiver" radio not programmed correctly or not operating correctly.</li> </ol>
"Transmitter" radio keying continuously or keying without a "properly" identified signal presented to "receiver" radio.	<ol style="list-style-type: none"> <li>1. "Receiver" radio on wrong channel (mode).</li> <li>2. Wrong PL/DPL programmed into "receiver" radio.</li> <li>3. Accessory connector of "receiver" radio not programmed correctly or not operating correctly.</li> <li>4. S2 of R*I*C*K not configured correctly.</li> <li>5. J4-3 of R*I*C*K pulled LOW by an accessory.</li> <li>6. If using VOX, JU551 in "receiver" radio in "flat/unmuted" ("A") position. Move JU551 to "B" position.</li> </ol>
Erratic output power level from "transmitter" radio.	<ol style="list-style-type: none"> <li>1. If using ignition sense, voltages at power connector and J3-10 of "transmitter" radio differ by more than 0.6Vdc.</li> <li>2. Inadequate power supply current capability.</li> <li>3. Loose antenna connector.</li> <li>4. Faulty antenna or feedline.</li> </ol>
"Transmitter" radio keys but no or low audio is transmitted.	<ol style="list-style-type: none"> <li>1. Loose or bad cable(s).</li> <li>2. S2 of R*I*C*K not configured correctly.</li> <li>3. JU551 missing on logic board of "receiver" radio.</li> <li>4. R23 of R*I*C*K not adjusted correctly.</li> <li>5. J4-5 or J4-2 shorted due to connections to "J4-ACC" of R*I*C*K.</li> <li>6. Audio loaded by an accessory connected to "J4-ACC" of R*I*C*K.</li> <li>7. Audio loaded by microphone plugged into "transmitter" radio (and/or "receiver" radio in bi-directional repeater). DTMF microphone may cause this problem.</li> </ol>
No speaker audio heard from "transmitter" radio in bi-directional repeater configuration.	<ol style="list-style-type: none"> <li>1. J3-15 and J3-16 of "transmitter" radio not jumpered together.</li> <li>2. Loose or bad cable from "transmitter" radio to R*I*C*K.</li> <li>3. Volume control of "transmitter" radio turned down.</li> <li>4. Speaker wires not connected between speaker and J10 on logic board of "transmitter" radio.</li> <li>5. External speaker (if applicable) not connected between J3-1 and J3-16 of "transmitter" radio.</li> <li>6. Defective speaker (internal or external, if applicable).</li> </ol>
Long delay in audio from microphone plugged into "transmitter" radio.	<ol style="list-style-type: none"> <li>1. S2-5 and S2-6 simultaneously ON. Either S2-5 (flat audio) or S2-6 (EIA audio) should be ON and the other must be OFF.</li> </ol>

Table 7. R\*I\*C\*K Setup/Knockdown Problems

Problem	Possible Cause
R*I*C*K not in "Setup" mode at power-up, yellow LED not lighted and/or "transmitter" radio front panel not ON.	<ol style="list-style-type: none"> <li>1. JU1 of R*I*C*K in wrong position or missing.</li> <li>2. Loose or bad cable from R*I*C*K to "transmitter" radio.</li> <li>3. "Transmitter" radio on/off switch in OFF position.</li> <li>4. Power source not connected to "transmitter" radio.</li> </ol>
R*I*C*K not in "Knockdown" state at power-up, yellow LED lighted and/or "transmitter" radio front panel ON.	<ol style="list-style-type: none"> <li>1. JU1 of R*I*C*K in wrong position.</li> <li>2. Ignition sense fuse (F801) or jumper (JU801) not removed from logic board of "transmitter" radio.</li> </ol>
Transition from "Setup" to "Knockdown" state not occurring when front panel switch (S3) is pressed and released.	<ol style="list-style-type: none"> <li>1. JU1 of R*I*C*K missing.</li> <li>2. Loose or bad cable from R*I*C*K to "transmitter" radio.</li> <li>3. "Transmitter" radio on/off switch in OFF position.</li> <li>4. Power source not connected to "transmitter" radio.</li> <li>5. Ignition sense fuse (F801) or jumper (JU801) not removed from logic board of "transmitter" radio.</li> </ol>
Remote Setup/Knockdown function not working.	<ol style="list-style-type: none"> <li>1. S2-4 not ON.</li> <li>2. Ignition sense fuse (F801) or jumper (JU801) not removed from logic board of "transmitter" radio.</li> <li>3. "Transmitter" radio on/off switch in OFF position.</li> <li>4. Power supply not connected to "transmitter" radio.</li> <li>5. JU1 of R*I*C*K in wrong position or missing.</li> <li>6. Loose or bad cable(s).</li> <li>7. Incorrect MDC-1200 programming of "receiver" radio.</li> </ol>

## GLOSSARY

Unless specified otherwise, Radius M200 series radios are required.

**B308:** an option for the older M206 and M214 radios which adds the 16-pin accessory connector with programmable I/O.

**B833:** an option for the older M206 and M214 radios which includes the B308 option plus Rapid-Call signaling.

**Bi-directional repeater:** a repeater configuration in which the "receiver" and "transmitter" radios perform both receive and transmit functions. The audio and COR signals from the receiver of the "receiver" radio are routed to the transmitter of the "transmitter" radio. Unlike the unidirectional case, though, the audio and COR signals of the receiver of the "transmitter" radio are also routed to the transmitter of the "receiver" radio. Example: the "receiver" radio receives a signal on 159.420 MHz which is re-transmitted by the "transmitter" radio on 451.650 MHz. The "transmitter" radio then receives a signal on 451.650 MHz which is re-transmitted by the "receiver" radio on 159.420 MHz.

**Console radio:** a fixed (base station) or a mobile radio installation that has been designated as the controlling radio for the repeater or as the "hub" for communications. The console radio is not part of the repeater hardware.

**CSQ:** Carrier Squelch.

**COR ("Carrier Operated Relay"):** a carry-over term from the early days of repeater operation. COR is used in its generic sense and does not necessarily mean only Carrier Squelch operation. For the Radius 2-mobile repeater configurations, the COR signal is found on pin 8 or pin 14 of the 16-pin accessory jack (J3) of the radio. Whenever a "properly" identified signal is received a dc level change will occur on pin 8 or pin 14.

**Cross band repeater:** a repeater in which the "receiver" radio operates in a different frequency band than the "transmitter" radio. Example: the "receiver" radio operates on 159.420 MHz in the highband VHF and the "transmitter" radio operates on 451.650 MHz in the 450-470 MHz UHF band. Crossband repeaters may be either unidirectional or bi-directional.

**Drop out delay:** the time, in seconds, that the "transmitter" radio remains keyed, or on the air, after the input signal to the "receiver" radio ceases. Also known as "hang time".

**EIA de-emphasized audio:** the audio frequency response of the receiver that is measured at the speaker and at J3 pin 11 of the radio with JU551 in the "B" position.

**EIA pre-emphasized audio:** the audio frequency response of the transmitter for an audio input to the microphone or J3 pin 2.

**Field radio:** a mobile or portable radio that is neither a part of the repeater hardware nor a console radio. Field radios may intercommunicate via the repeater or directly.

**Flat audio:** receiver or transmitter audio that does not change appreciably in amplitude as the frequency of that audio is varied from 1 Hz to 3 kHz. The receiver audio response from J3 pin 11 with JU551 in the "A" position and the transmitter audio response for input to J3 pin 5 are "flat".

**M200 series:** a series of Radius radios that include the newer models M208 and M216 or the older models M206 and M214 with either the B308 option or the B833 option. The B833 option is required for remote Setup/Knockdown operation.

**Normal receiver audio:** see EIA de-emphasized audio.

**"Normal" repeater:** a repeater that uses an M200 series radio as the "receiver" radio and interconnects to the R\*I\*C\*K with a 16-conductor cable. Not a "VLC" repeater. May be bi-directional or unidirectional.

**PAC\*RT:** Portable Area Communications Repeater; a specialized cross band, bi-directional repeater configuration. Example: paramedics at an accident scene may use 450-470 MHz UHF portable radios to communicate with a highband VHF dispatcher.

**Power-up:** the initial application of operating potential (voltage) to the radios and the R\*I\*C\*K.

**"Properly" identified signal:** all signals being received on a CSQ receiver or those signals with the correct PL tone or DPL code being received on a coded squelch receiver.

**"Receiver" radio:** the radio that is connected to "J5-RX" (or "J1-RX") of the R\*I\*C\*K.

**Repeater knockdown:** to deactivate or to remove from service a repeater.

**Repeater setup:** to activate or to place into service a repeater.

**R\*I\*C\*K:** Repeater\*Interface\*Communications\*Kit

**Single band repeater:** a repeater in which both the "receiver" radio and the "transmitter" radio operate in the same frequency band. Example: receive at 456.650 MHz and transmit at 451.650 MHz in the 450-470 MHz UHF band.

**"Transmitter" radio:** the radio that is connected to "J3-TX" (or "J2-TX") of the R\*I\*C\*K.

**Unidirectional repeater:** a repeater configuration in which the "receiver" radio only receives signals from the field radios and the "transmitter" radio only transmits signals to the field radios. The "transmitter" radio may be an M100, M200 series,

or M400.

**"VLC" repeater:** a Very Limited Capability, unidirectional repeater configuration that may be constructed with two Radius M100 radios. All audio and PTT signals are obtained from the front panel microphone jacks of the two radios via 6-pin to 8-pin modular (telco) cables. A VOX circuit in the R\*I\*C\*K rectifies the handset audio from the "receiver" radio and keys the "transmitter" radio via the dropout delay generator in the R\*I\*C\*K. This configuration is not recommended except where a repeater must be quickly assembled.

**VOX:** VOice controlled transmission; the "transmitter" radio is keyed by a circuit that detects the presence of voice output from the "receiver" radio.



S1 - Rptr Em - shown OFF

REPEATER INTERFACE COMMUNICATIONS KIT (R\*I\*X\*C\*X\*K)

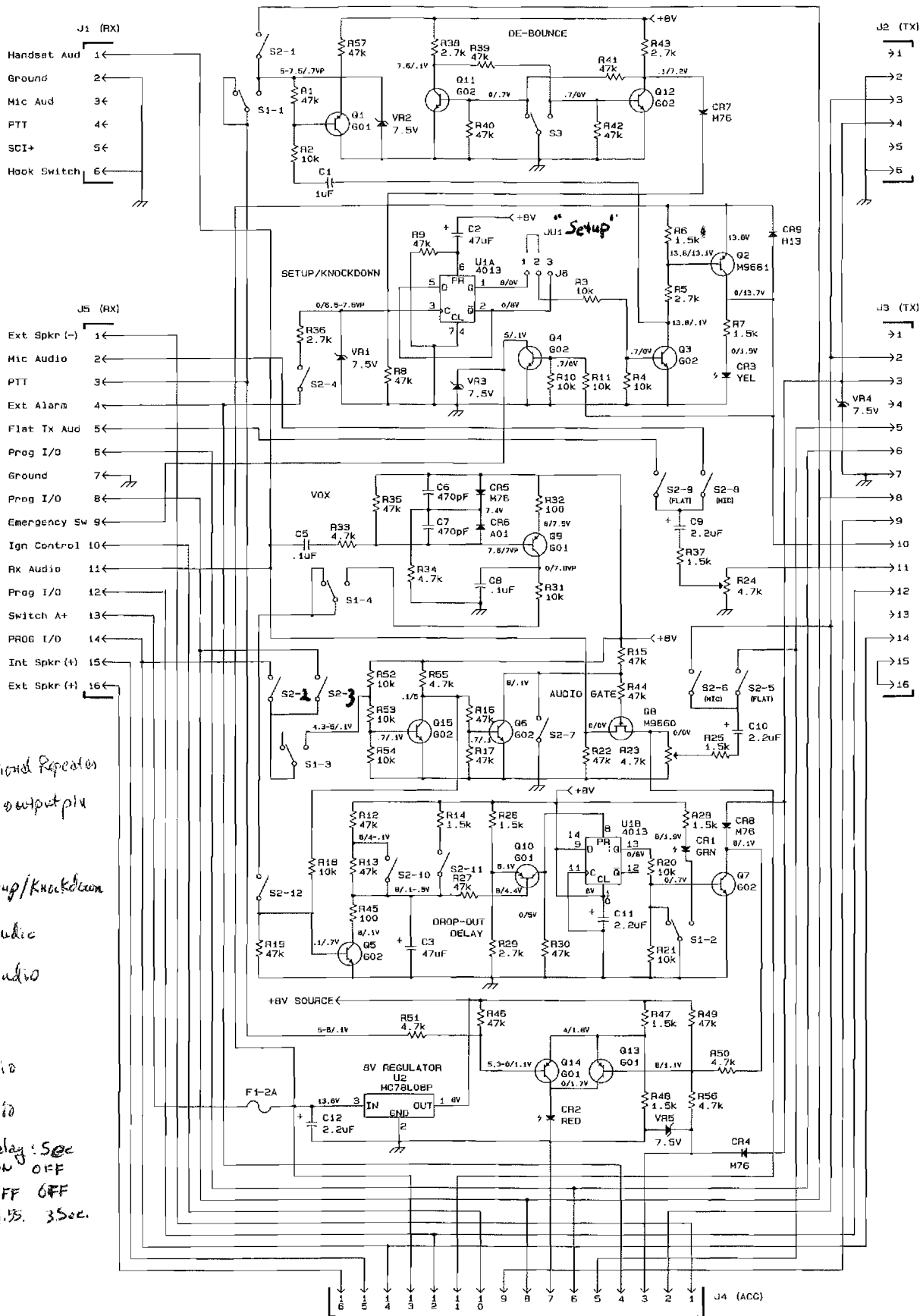

- 52-
- 1 Bi Directional Repeater
  - 2 } Rx pl/csa output pin select
  - 3 }
  - 4 - Remote Setup/Knockdown
  - 5 Flat TX Audio
  - 6 Mic TX Audio
  - 7
  - 8 Mic TX Audio
  - 9 Flat TX Audio
  - 10 } drop-out delay: Sec
  - 11 } ON ON OFF
  - 12 } ON OFF OFF
  - 12 } "0" 1.5s. 3Sec.
  - 12 VOX

NOTES: 1. Pin assignments for J1 and J2 are identical.  
 2. Pin assignments for J3, J4 and J5 are identical.  
 3. JU1-At power up: 1-2 for rptr on/2-3 for rptr off.  
 4. All voltages are dc and measured with hi-z DMM.  
 5. S1 and all sections of S2 are shown "OFF".  
 6. Voltages shown are Inactive/Active state.  
 "p" after a voltage means pulsed (not continuous).

7. Measure voltages with RHIMCK in normal operation with radios attached to J3-TX AND J5-RX. S1, "Repeater Enable", S2-4 and either S2-2 or S2-3 must be "ON". S2-12 must be "ON" to check VOX.

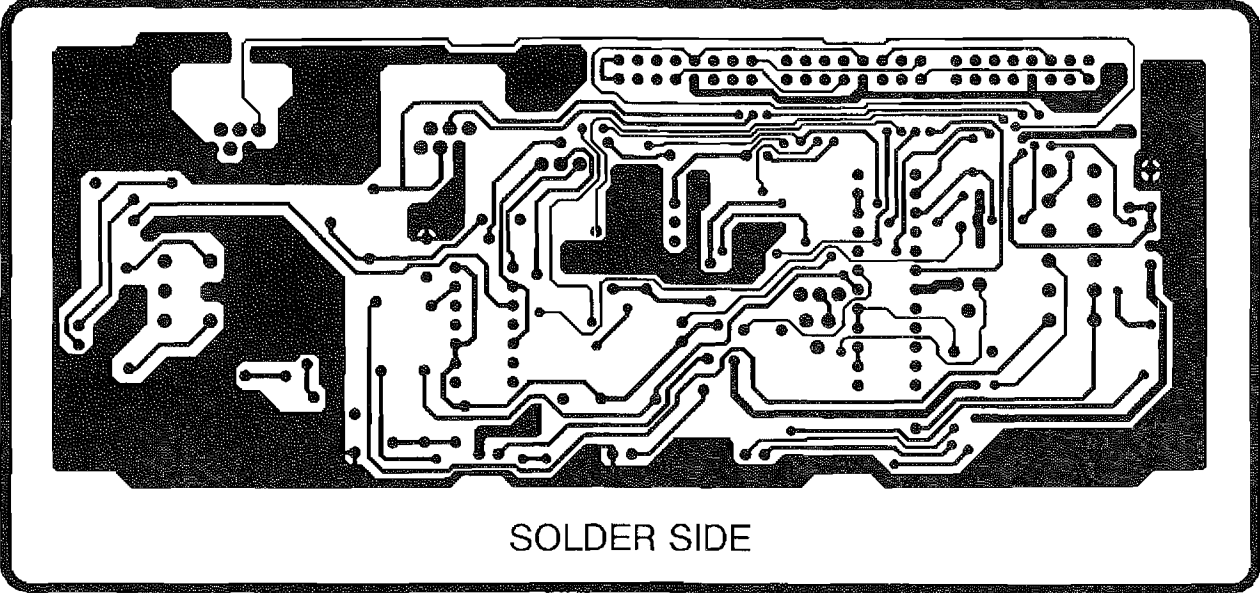

SOLDER SIDE

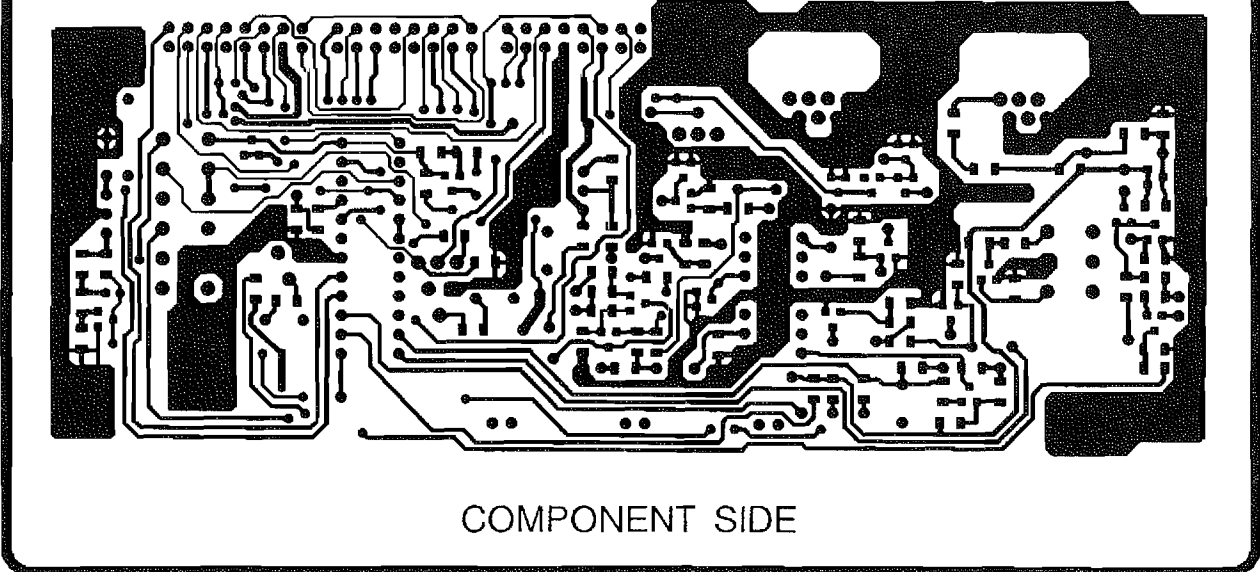
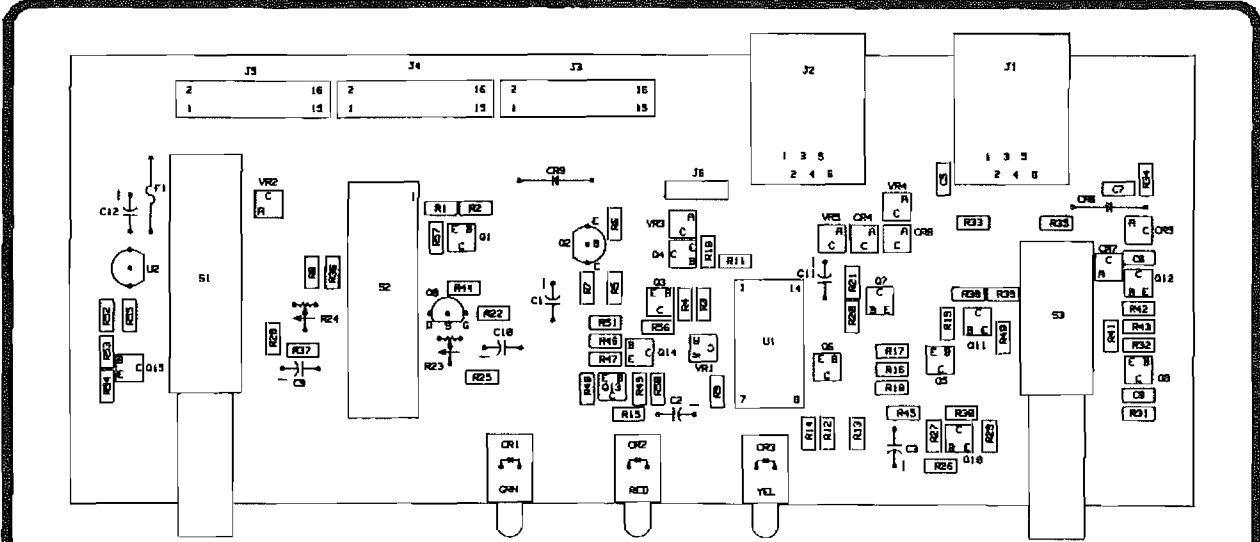

COMPONENT SIDE

HLN9809B R\*I\*C\*K Circuit Board

REFERENCE NUMBER	MOTOROLA PART NO.	DESCRIPTION
------------------	-------------------	-------------

Capacitors, chip, 5%, 50V unless otherwise indicated

C1	08-11051A19	poly 1 uF 63V
C2	23-11048B19	lytic 47 uF 20% 16V
C3	23-11048B19	lytic 47 uF 20% 16V
C5	21-13741B69	.1 uF
C6	21-13740B65	470 pF
C7	21-13740B65	470 pF
C8	21-13741B69	.1 uF
C9	23-11048B06	lytic 2.2 uF 20%
C10	23-11048B06	lytic 2.2 uF 20%
C11	23-11048B06	lytic 2.2 uF 20%
C12	23-11048B06	lytic 2.2 uF 20%

Diodes (see note)

CR1	48-88245C22	light emitting, GRN
CR2	48-88245C24	light emitting, RED
CR3	48-88245C23	light emitting, YEL
CR4	48-05129M76	silicon MMBD914
CR5	48-05129M76	silicon MMBD914
CR6	48-84616A01	hot carrier
CR7	48-05129M76	silicon MMBD914
CR8	48-05129M76	silicon MMBD914
CR9	48-80008E01	silicon 1N4005

Fuse

F1	65-05214E04	2 amp
----	-------------	-------

Jumpers

JU1	09-84181L01	push-on, 2-pin
-----	-------------	----------------

Connectors

J1	09-83112N01	6-pin "TELCO"
J2	09-83112N01	6-pin "TELCO"
J3	28-80923V01	male, 16-pin
J4	28-80923V01	male, 16-pin
J5	28-80923V01	male, 16-pin
J6	28-80002R03	3-pin header

Transistors (see note)

Q1	48-80214G01	PNP; type MMBT3906
Q2	48-00869681	PNP; type M9681
Q3	48-80214G02	NPN; type MMBT3904
Q4	48-80214G02	NPN; type MMBT3904
Q5	48-80214G02	NPN; type MMBT3904
Q6	48-80214G02	NPN; type MMBT3904
Q7	48-80214G02	NPN; type MMBT3904
Q8	48-00869660	field effect; type 2N5461
Q9	48-80214G01	PNP; type MMBT3906
Q10	48-80214G01	PNP; type MMBT3906
Q11	48-80214G02	NPN; type MMBT3904
Q12	48-80214G02	NPN; type MMBT3904
Q13	48-80214G01	PNP; type MMBT3906
Q14	48-80214G01	PNP; type MMBT3906
Q15	48-80214G02	NPN; type MMBT3904

Resistors, chip, 5%, 1/8 watt

R1	06-11077B15	47k
R2	06-11077A98	10k
R3	06-11077A98	10k
R4	06-11077A98	10k
R5	06-11077A84	2.7k
R6	06-11077A78	1.5k
R7	06-11077A78	1.5k
R8	06-11077B15	47k
R9	06-11077B15	47k

R10	06-11077A98	10k
R11	06-11077A98	10k
R12	06-11077B15	47k
R13	06-11077B15	47k
R14	06-11077A78	1.5k
R15	06-11077B15	47k
R16	06-11077B15	47k
R17	06-11077B15	47k
R18	06-11077A98	10k
R19	06-11077B15	47k
R20	06-11077A98	10k
R21	06-11077A98	10k
R22	06-11077B15	47k
R23	18-05500L05	variable, 4.7k
R24	18-05500L05	variable, 4.7k
R25	06-11077A78	1.5k
R26	06-11077A78	1.5k
R27	06-11077B15	47k
R28	06-11077A78	1.5k
R29	06-11077A84	2.7k
R30	06-11077B15	47k
R31	06-11077A98	10k
R32	06-11077A50	100
R33	06-11077A90	4.7k
R34	06-11077A90	4.7k
R35	06-11077B15	47k
R36	06-11077A84	2.7k
R37	06-11077A78	1.5k
R38	06-11077A84	2.7k
R39	06-11077B15	47k
R40	06-11077B15	47k
R41	06-11077B15	47k
R42	06-11077B15	47k
R43	06-11077A84	2.7k
R44	06-11077B15	47k
R45	06-11077A50	100
R46	06-11077B15	47k
R47	06-11077A78	1.5k
R48	06-11077A78	1.5k
R49	06-11077B15	47k
R50	06-11077A90	4.7k
R51	06-11077A90	4.7k
R52	06-11077A98	10k
R53	06-11077A98	10k
R54	06-11077A98	10k
R55	06-11077A90	4.7k
R56	06-11077A90	4.7k
R57	06-11077B15	47k

Switches

S1	40-84324C10	4PDT
S2	40-83022M04	SPST (12 pos)
S3	40-80065E02	DPDT

Integrated circuits (see note)

U1	51-84887K13	MC14013 CMOS dual D flip-flop
U2	51-84621K73	MC78L08P 8 volt regulator

Voltage regulator, 250 mW (see note)

VR1	48-80140L11	zener diode 7.5V SOT
VR2	48-80140L11	zener diode 7.5V SOT
VR3	48-80140L11	zener diode 7.5V SOT
VR4	48-80140L11	zener diode 7.5V SOT
VR5	48-80140L11	zener diode 7.5V SOT

Non-referenced items

14-84360C01	insulator (two used under S1, one used under S3)
-------------	--

Note: For optimum performance, diodes, transistors and integrated circuits must be ordered by Motorola part numbers.

HLN9822B R\*I\*C\*K Hardware Kit

REFERENCE NUMBER	MOTOROLA PART NO.	DESCRIPTION
Non-referenced items		
	03-10908A33	screw M3.5x.6x30mm (2 used)
	15-80529B01	housing, back
	15-80530B01	cover, front
	32-80243L01	gasket, housing
	38-80057L01	push button (2 used)

5/13/91

PL-911002-A

HKN9837A R\*I\*C\*K Intercabling Kit

REFERENCE NUMBER	MOTOROLA PART NO.	DESCRIPTION
Non-referenced items		
	01-80970X01	shorting plug (2 used)
	09-82845L01	connector crimp (2 used)
	30-80043N05	cable, coiled
	30-80137S01	cable, repeater (2 used)

1/16/91

PL-911003-O

HLN9839B R\*I\*C\*K Mounting Hardware Kit

REFERENCE NUMBER	MOTOROLA PART NO.	DESCRIPTION
Non-referenced items		
	03-138021	screw 10-16x3/4 (4 used)
	03-80105F01	wing screw (2 used)
	07-80126J02	bracket, trunnion
	43-80127J01	spacer, trunnion (2 used)

5/2/91

PL-911004-A

## Index

- Accessories, Radius (see separate listings)
  - RSS screens, 23-27
  - R\*I\*C\*K compatibility, 22
- Antenna spacing, 20
- Bi-directional repeater
  - definition, 36
  - dip switch (S2), 6, 29
  - example, 3-8
  - M200, ii, 3-5, 7, 8
  - problems (troubleshooting), 32, 34, 35
  - radio compatibility, ii
  - "receiver" radio, ii, 3, 4, 7
  - RSS screens: "receiver" radio, 7
  - "transmitter" radio, 8
  - R\*I\*C\*K adjustments, 17, 18
  - R\*I\*C\*K and radio interconnection, 17
  - R\*I\*C\*K worksheet, 14, 15
  - "transmitter" radio, ii, 4, 5, 8
- Coaxial cables
  - connectors, 19, 21
  - maximum lengths, 21
  - types, 19-21
- COR, 14, 30, 36
  - definition, 36
- Dip switch (S2), setting
  - accessories, operating with, 22
  - bi-directional repeater, 5, 6
  - functions, 29
  - R\*I\*C\*K worksheet, 14, 15
  - unidirectional repeater, 10, 11
- Drop-out delay
  - bi-directional repeater, 5, 15, 29
  - definition, 36
  - theory of operation, 30
  - unidirectional repeater, 9, 10, 15, 29
- DTMF Decoder accessory, 22
- Duplexer, 2, 19
- Examples
  - bi-directional repeater, 3-8
  - unidirectional repeater, 9-13
- FCC, 1, 16
- Feedlines, RF (see "Coaxial cables")
- General I/O accessory
  - bi-directional repeater, 3, 4, 7, 8
  - DTMF decoder, 22
  - Modem paging, 22, 23
  - unidirectional repeater, 9, 12
- Knockdown (see "Setup/Knockdown")
- Lightning protection, 42, 43
- M100 Radius radio
  - connect to R\*I\*C\*K, 17
  - repeater compatibility, ii
  - "receiver" radio, ii, 17, 36
  - RSS screens, 13
  - R\*I\*C\*K worksheet, 14, 15
  - "transmitter" radio, 10
- M200 series Radius radio
  - connect to R\*I\*C\*K, 17
  - repeater compatibility, ii
  - "receiver" radio, 3, 4, 7, 9, 10, 12
  - RSS screens, 7, 8, 12, 13, 23-27
  - R\*I\*C\*K worksheet, 14, 15
  - "transmitter" radio, 4, 5, 11
- M400 Radius radio
  - interfacing to R\*I\*C\*K, 16
  - repeater compatibility, ii
  - R\*I\*C\*K worksheet, 14, 15
- MDC-1200 Console accessory, 22
- Modem Paging accessory, 22, 23
- "Normal" repeater, 17, 36
- Phone Patch accessory, 22, 24
- Public Address accessory, 22, 25
- Radius "2-mobile" repeater
  - configurations, 1
  - definition, 1
  - examples, (see "bi-directional repeater" and "unidirectional repeater")
  - uses, 1
- RPB50 accessory, 22, 27
- "Receiver" radio
  - bi-directional repeater, 3, 4, 7
  - definition, 36
  - problems, 35
  - radio compatibility, ii
  - R\*I\*C\*K worksheet, 14, 15
  - RSS screens, 7, 12, 23-27
  - unidirectional repeater, 9, 10, 12
- Remote accessory, 22, 26
- R\*I\*C\*K
  - accessory compatibility, 22
  - contents, 1
  - definition, 1, 36
  - dip switch (S2), 5, 6, 10, 11, 14, 15, 18, 22, 28-35, 38
  - parts list, 40, 41
  - PC board overlay, 39
  - schematic, 38
  - theory of operation, 30, 31
  - problems (troubleshooting), 32-35
- RSS (Radio Service Software)
  - screens, 7, 8, 12, 13, 23-27
- Setup (see "Setup/Knockdown")
- Setup/Knockdown
  - dip switch (S2), 29
  - operation, 28
  - problems (troubleshooting), 35
  - radio compatibility, ii
  - R\*I\*C\*K worksheet, 14, 15
  - theory of operation, 30
- Transmission lines (see "Coaxial cables")
- "Transmitter" radio
  - bi-directional repeater, 4, 5, 8
  - definition, 37
  - problems, 34
  - radio compatibility, ii
  - R\*I\*C\*K worksheet, 14, 15
  - RSS screens, 8, 13, 23-27
  - unidirectional repeater, 10, 11, 13
- Unidirectional repeater
  - definition, 37

## Unidirectional repeater, continued

- dip switch (S2), 11, 29
- example, 9-13
- M100, ii, 10, 13-15, 22
- M200, ii, 9-13
- M400, ii, 16, 22
- problems (troubleshooting), 32-35
- radio compatibility, ii
- "receiver" radio, ii, 9, 10, 12
- RSS screens: "receiver" radio, 12
- "transmitter" radio, 13
- R\*I\*C\*K adjustments, 17, 18
- R\*I\*C\*K and radio interconnection, 17
- R\*I\*C\*K worksheet, 14, 15
- "transmitter" radio, ii, 10, 11, 13

## VOX

- definition, 37
- dip switch (S2), 29
- R\*I\*C\*K worksheet (VLC), 14, 15
- theory of operation, 30
- trouble, 32
- VLC, operation with, 17
- VLC (Very Limited Capability)
  - adjustments, 17, 18
  - definition, 37
  - radio compatibility, ii
  - R\*I\*C\*K adjustments, 17, 18
  - R\*I\*C\*K and radio interconnection, 17
  - R\*I\*C\*K worksheet, 14, 15
- Worksheet, R\*I\*C\*K, 14, 15



**R**epeter  
**I**nterface  
**C**ommunications  
**K**it

6880901Z79-B

Motorola, , and Radius are registered  
trademarks of Motorola, Inc.



\* 6 8 8 0 9 0 1 2 7 9 \*