

DIN 41612 - C

MABC96LP

X1

A B C
N0MJS
N3XC

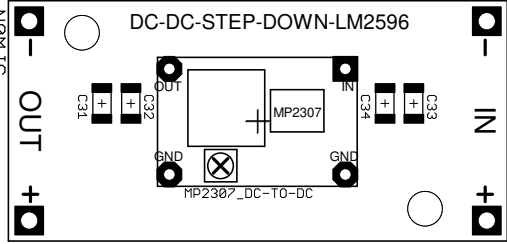

Repeater Builder
STM32-DVM-MTR2K V2a
(C) 2020 - N3XC

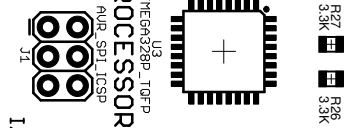

JP11 SERIAL EN.

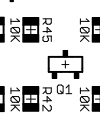

UART LEVEL SHIFT

NanoPi NEO

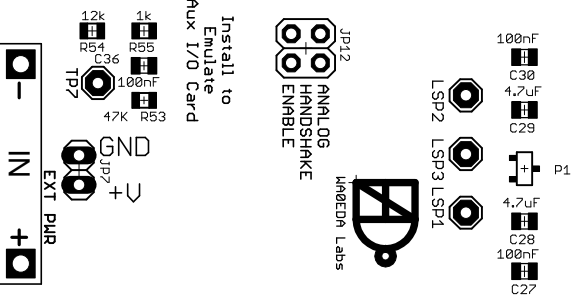

AVR RESET

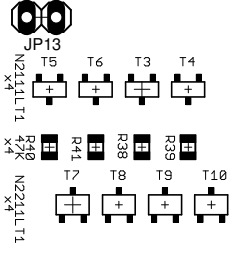

TX

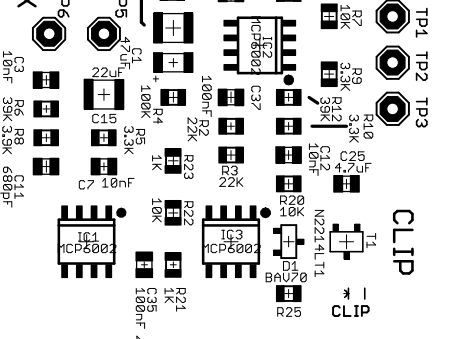

CLIP



SBC SERIAL

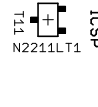

MODEM



MODEM RESET



LOAD



SBC OLED



MODEM NEXTION



I/O INDICATORS
MODEM INDICATORS



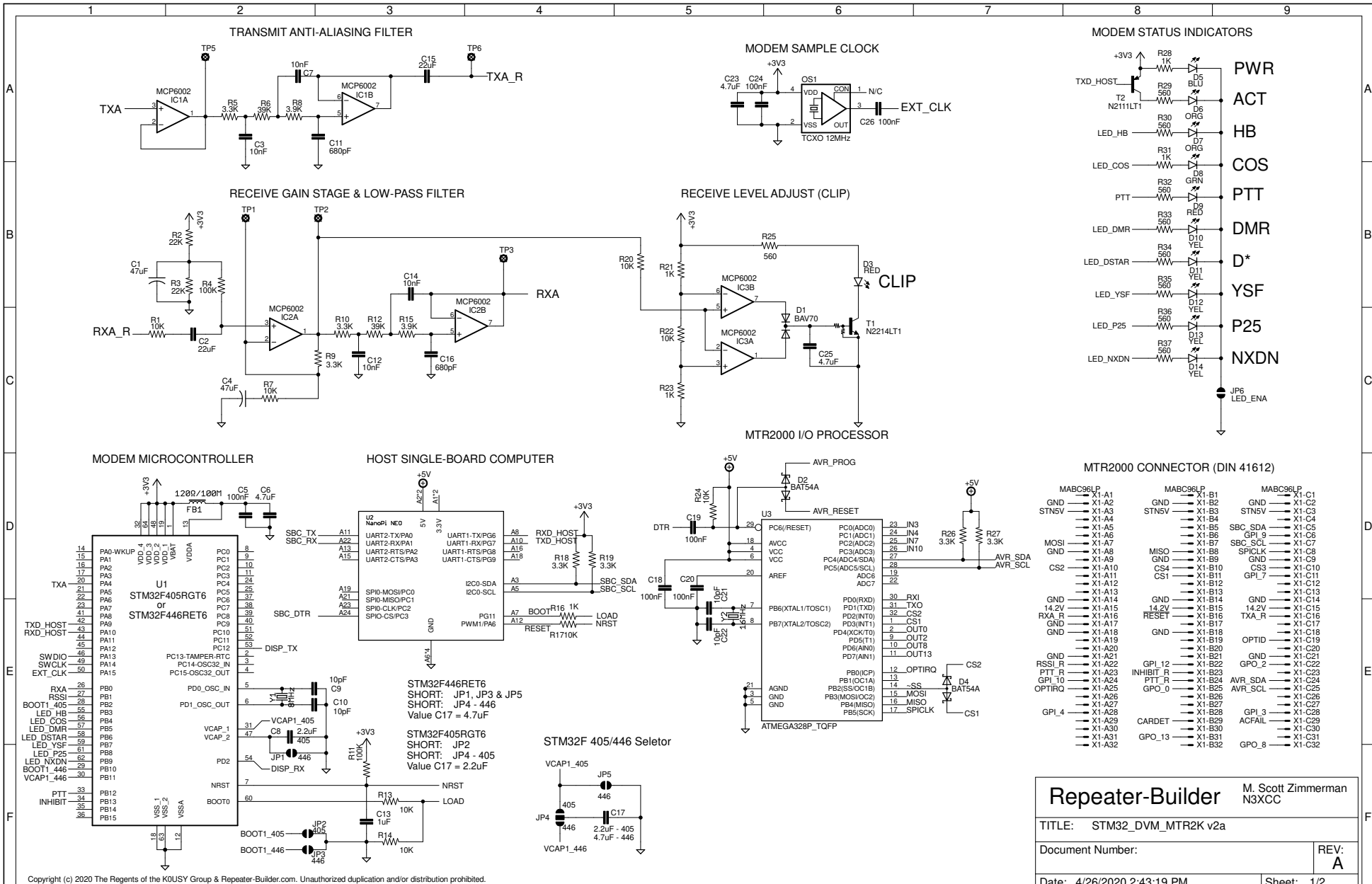

POWER SUPPLIES/FEEDS

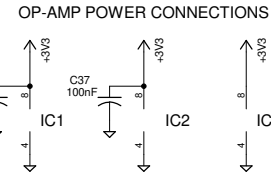
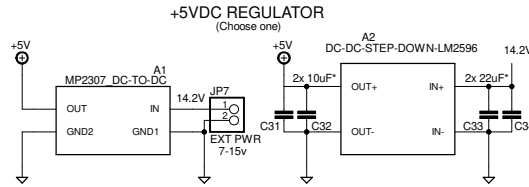
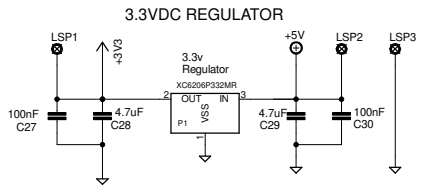

PIN HEADERS

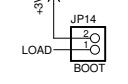
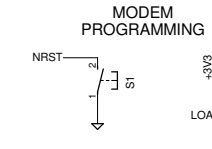
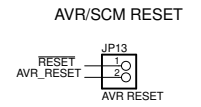
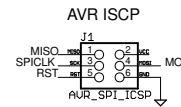
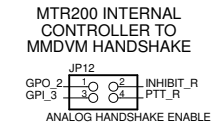
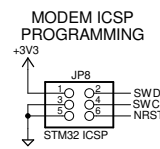
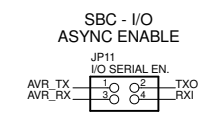
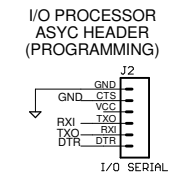
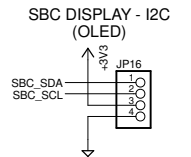
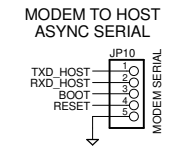
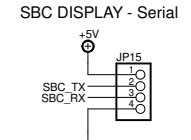
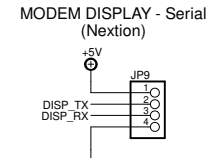

DIGITAL I/O BUFFERS

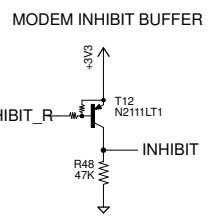
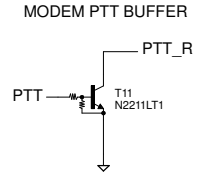
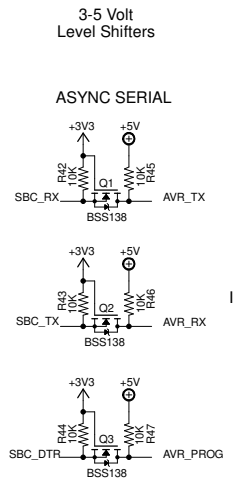
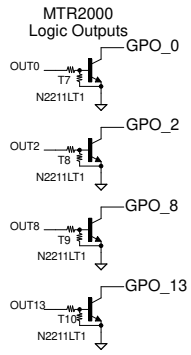
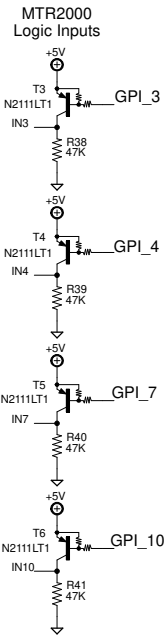

ANALOG CONDITIONING

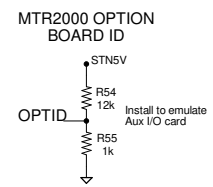
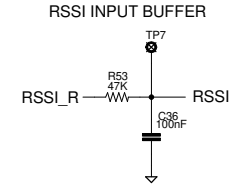

I/O INDICATORS

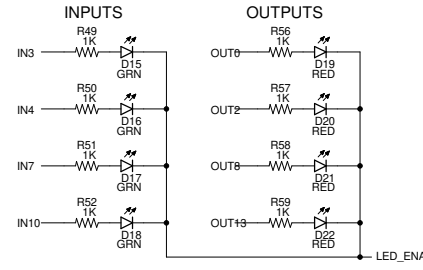

Repeater-Builder		M. Scott Zimmerman N3XCC	
TITLE: STM32_DVM_MTR2K v2a			
Document Number:			REV: A
Date: 4/26/2020 2:43:19 PM			Sheet: 2/2